

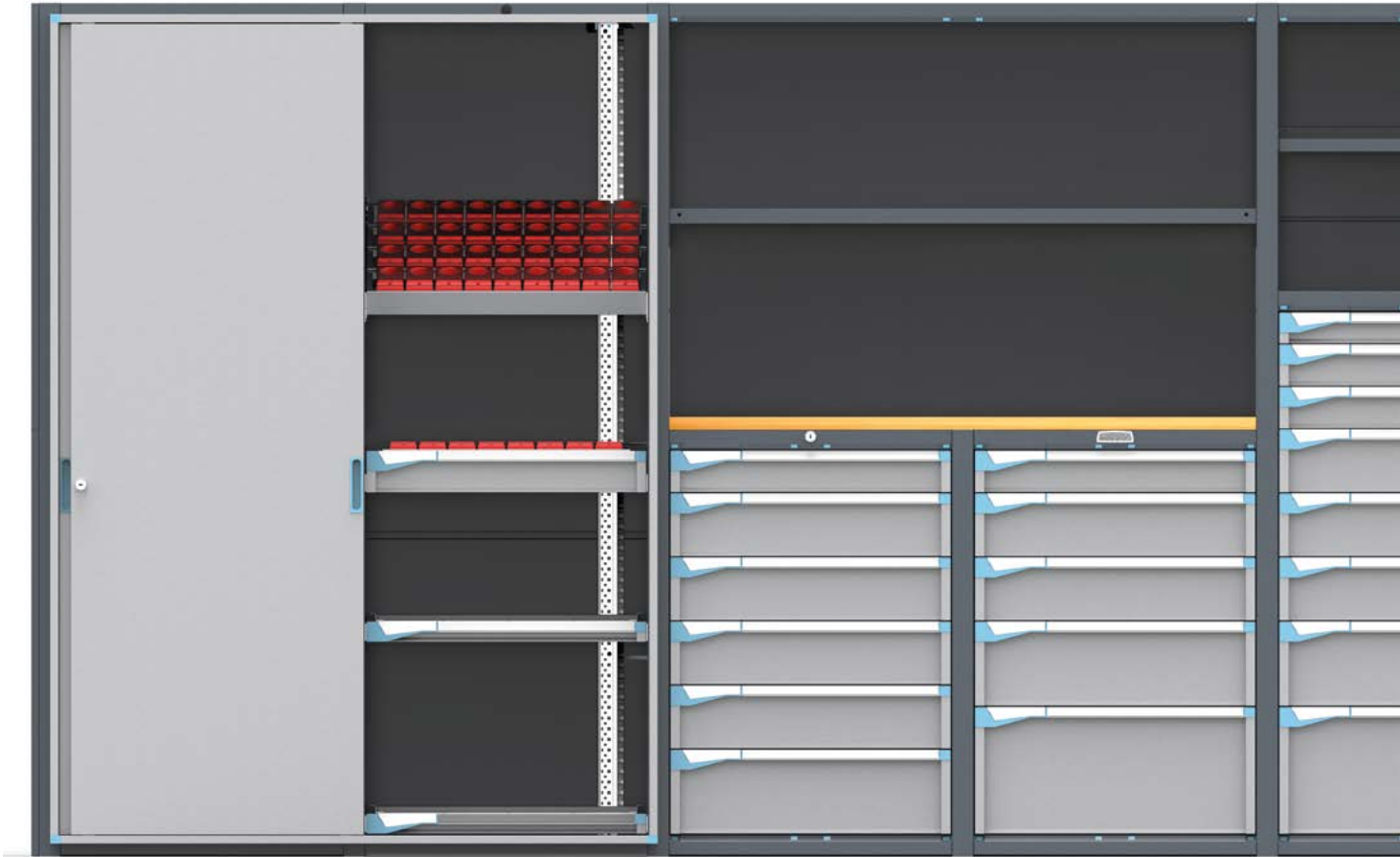

**THE RIGHT COMBINATION
BETWEEN THE MASTER
CABINET AND A RACKING
SYSTEM STRONG
VERSATILE MODULAR 3
DOOR TYPES HINGED,
SLIDING, SHUTTER DOORS
10 COLOURS AVAILABLE**



SYSTEM SR-MASTER



CAPACITY EACH BAY SPAN

		mm
CAPACITY EACH BAY SPAN	DISTANCE BETWEEN STRENGTHENING SHELVES OR LOCK SHELVES	
4500	2000	
5000	1500	
5500	1000	

STRENGTHENING SHELVES OR LOCK SHELVES REQUIRED FOR EACH SPAN

mm	
HEIGHT SHELVING SYSTEM	NUMBER OF STRENGTHENING SHELVES OR LOCK SHELVES
1000	2
1500	2
2000	2
2250	3
2500	3
3000	3



SAFETY

FLOOR SUPPORT PLATE

The support plate is designed to distribute the pressure applied on the floor by the Side PANEL. A technical data sheet supplied by FAMI is useful to check the suitability of the floor intended for racking system installation.

recommended anchor strength	5,6 kN
anchor diameter	Ø10 mm
concrete hole diameter	Ø10 mm
minimum hole depth	h_1 70 mm
minimum installation depth	h_{nom} 50 mm
max adjustable thickness	t_{fix} 20 mm
max tightening torque	T_{inst} 25 NM

min floor thickness for anchor plug fixing*	H: 100 mm
min anchor distance from the edge of the floor	B: 50 mm
anchor strength application area**	A: 75 mm
min upright distance from the edge of the floor	C: 0 mm

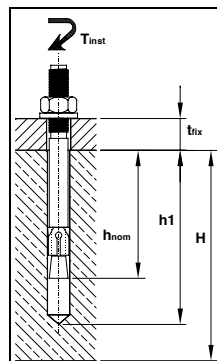

* The floor on which the racking system rests must be checked in terms of suitability for withstanding the pressure and the puncturing (drilling) stress applied by the shelving system itself and the pulling strength exerted by the anchor.

**The area must not be submitted to any other force.

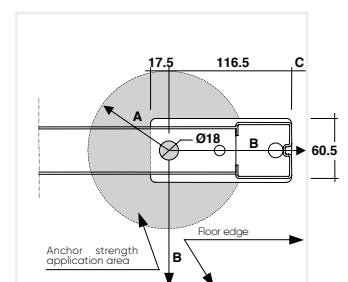

TECHNICAL SPECIFICATIONS

The new SYSTEM SR-MASTER racks combine the advantages of a shelving unit with the advanced technology and uniqueness of a Master tool storage cabinet to offer innovative, high performance, modular logistics solutions, safe and personalised, with exclusive versions designed for the industrial storage equipment market.

COLOURS

CABINET

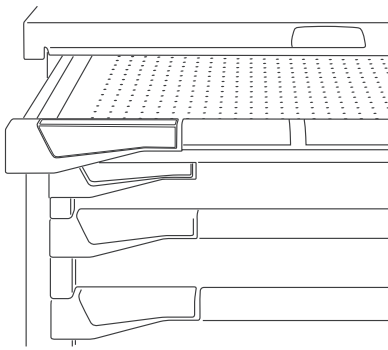

10 colours for the metal part



8 colours for plastic accessories

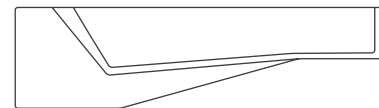

FRONT HANDLE



SIDE

Made of sectional steel, it features slots to a 25 mm pitch on both upright frames. The elements that compose it – uprights, connecting cross bars and feet – are welded together and this allows for a capacity of up to 5,500 kg per bay span.



SIDE, MIDDLE AND REAR WALLS

The side, middle and rear walls are made of sheet plate, joined together to form closed compartments.

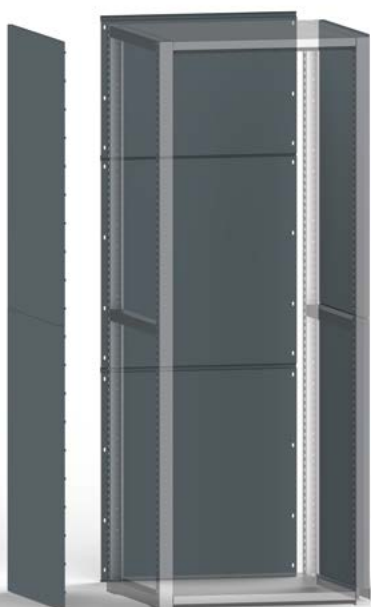

ACCESSORIES

PARTITIONS

The partitions are inserted in the slots provided in the shelves to a pitch of 40.5 mm. They have a height ranging from 100 to 200 mm and galvanised versions only are supplied. Ideally suitable for organising and optimising space on the shelf.

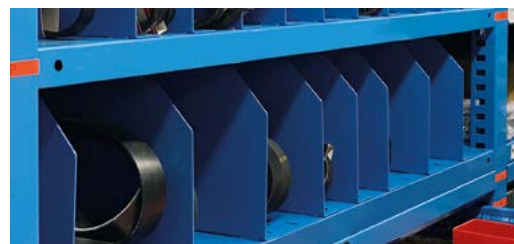

SEE PAGE 1381

BUSH HOLDER FRAMES

Useful for storing NC tools, they can be placed inside drawers or installed between upright frames in a hanging configuration. Must-have accessories for CNC machines, they protect from impacts and dust, organise the available space and optimise product withdrawal time.

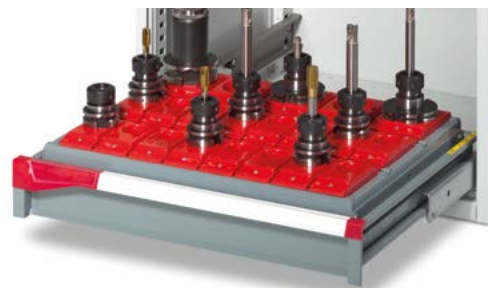

PARTITIONING MATERIAL

Longitudinal, transversal dividers, with 2-3-4 channels and divider boxes allow the drawer space to be divided in a rational way and according to specific operator needs.

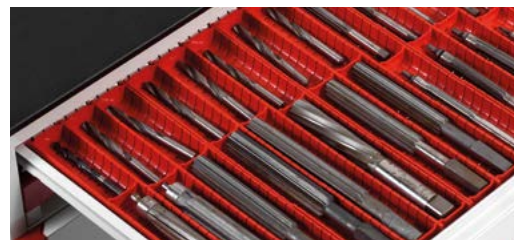

SEE PAGE 1383/379

FLEXIBLE EXTENSION

New, flexible extension guide with mechanical adjustment of the extensible drawer/shelf rear stop in 3 different positions. It allows 3 different capacities to be obtained: 50, 75, 100 kg. Patented opening system allowing the user to customise extension and load capacity.



Patented opening system allowing the user to customise extension and load capacity.



92%	=	100 kg
96%	=	75 kg
100%	=	50 kg

TELESCOPIC EXTENSION

New telescopic extension guide (100% extensibility) guaranteeing a capacity of 200 kg in the 10 different dimensions available for the Master cabinet.

VERTEBRATE BAR

THE SYSTEM'S HEART AND BRAINS

The bar is an aluminium profile section that is always fixed and never rotates. The closing movement is obtained via blocks that move vertically - driven by one of the basic forces of physics: gravity. The simpler the movement, the less likely the possible breaks. Bar locking is obtained via a locking bolt system provided on the bar head.

EXTENSIBLE DRAWERS/SHELVES



The extensible drawers/shelves of the Master series can be independently fitted with both flexible and telescopic extension guides.



ADJUSTABLE SHELVES, STRENGTHENING SHELVES/LOCK SHELVES

The height adjustable middle shelves, supported by 4 hooks, are available in slotted versions, to contain partitions, with capacity ranging between 100 and 200 kg, and in non-slotted versions with capacity ranging between 70 and 150 kg.

The strengthening shelves, fixed with screws to the upright frames, are the "supporting columns" of the shelving system and vary in number (2-3) in relation to height. 250 kg capacity.

The lock shelves, which perform the same load-bearing function as the strengthening shelves, are designed to contain the lock with cylinder or the numerical code lock and support the vertebrate bar. 150 kg capacity.



SLIDING DOORS

They are made of sheet steel specially shaped to ensure solidity, with a footprint depth of 50 mm. Doors are used to protect the shelved goods from impacts and dust. They are supplied with cylinder locks with two keys.



ROLLER SHUTTER

The roller shutter doors are made of grey plastic material with a steel sheet handle and an integrated cylinder lock. Ideal for small spaces, where it is not possible to use hinged doors, they move along the uprights on vertical guides.



HINGED DOORS

Hinged doors are made of sturdy, specially shaped steel sheet, with a footprint depth of 25 mm. The 3-point closure ensures high security against break-ins. Available with cylinder lock and two keys or numerical code lock.



VERTICAL DRAWERS

The vertical drawers, with a capacity of 400 kg, are suitable for containing both heavy materials, such as broaches, and miscellaneous materials, such as tools, eyebolts, or ropes, to be arranged on practical perforated panels.

CYLINDER CLOSURE

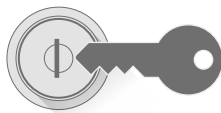

Transmission system from the closure cylinder to the head of the vertebrate bar with steel wire, with elastic sheath and linear movement.

The cylinder closure lock is divided into 23 different series: each series has keys numbered from 1 to 160, for a total of 3,680 different combinations.

SUPPLIED AS STANDARD WITH 2 KEYS

LOCK WITH DIGITAL CODE

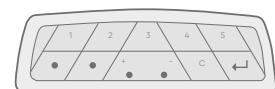

In addition to the standard cylinder closure, Fami decided to add a CODE lock to its closures. The numerical code lock controls the opening and closing of the vertebrate bar. It can manage up to 10 users with 3 to 8 digits numerical codes. The event history can be downloaded by connecting the keypad to the PC with a cable. Up to 10 remote controls are available on request.

SYSTEM SR-MASTER





SYSTEM SR-MASTER

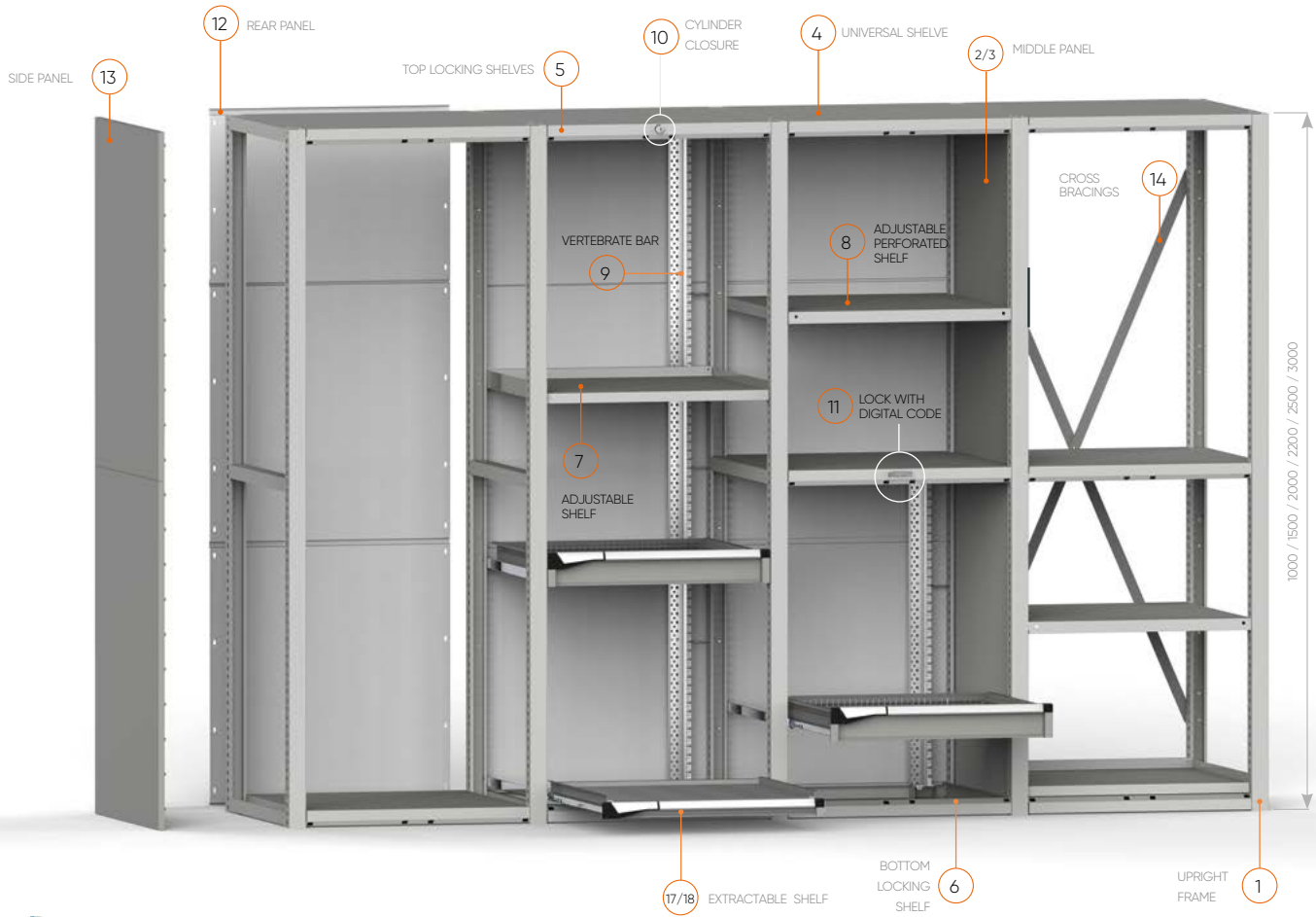

METAL COLOURS

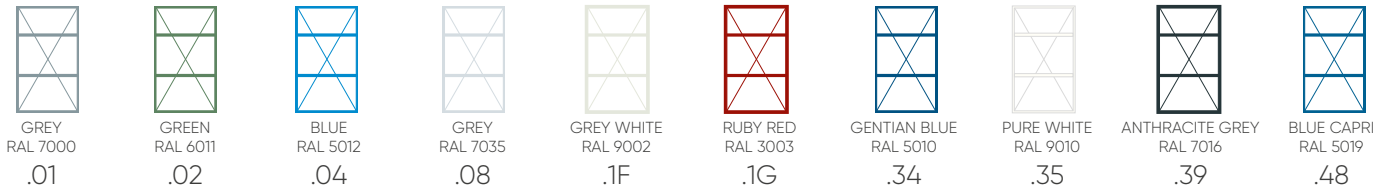

UPRIGHT FRAMES

1	ART.	Dim. mm
	M 02 F100 00 00 01	51x573x1000 H
	M 02 F150 00 00 01	51x573x1500 H
	M 02 F200 00 00 01	51x573x2000 H
	M 02 F225 00 00 01	51x573x2250 H
	M 02 F250 00 00 01	51x573x2500 H
	M 02 F300 00 00 01	51x573x3000 H

COMPLETE WITH CLOSING CAPS

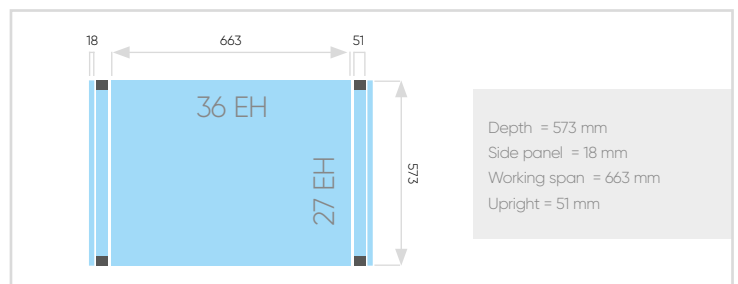

2 BOTTOM WALL

H side	ART.	Dim. mm H
1000	-	1000
1500	-	1500
2000	M 02 W100 M0 20 00	1000
2250	M 02 W100 M0 20 00	1000
2500	M 02 W100 M0 20 00	1000
3000	M 02 W100 M0 20 00	1000

3 TOP WALL

ART.	Dim. mm H
-	-
M 02 W100 M0 10 00	1000
M 02 W125 M0 10 00	1250
M 02 W150 M0 10 00	1500
M 02 W100 M0 10 00*	1000

MIDDLE PANELS

*For the 3000 mm height, two top middle walls are required to seal the side

UNIVERSAL SHELF

4	ART.		Dim. mm	
	M 32 PT46 00 10 00 _ _		663x571x46 H	
CAPACITY 250 kg				

TOP LOCKING SHELVES

5	ART.		Dim. mm	
	M 32 PS46 00 10 00 _ _		663x571x46 H	
CAPACITY 150 kg				

BOTTOM LOCKING SHELVES

6	ART.		Dim. mm	
	M 32 PS46 10 10 00 _ _		663x571x46 H	
CAPACITY 150 kg				

ADJUSTABLE SHELF

7	ART.		Dim. mm	
	M 32 PR25 00 00 01 _ _		657x478x60 H	
CAN BE FITTED FRONTALLY TO THE VERTEBRATE BAR CAPACITY 150 kg				

ADJUSTABLE PERFORATED SHELF

8	ART.		Dim. mm	
	M 32 PR35 10 00 01 _ _		663x568x35 H	
MAY NOT BE INSERTED IN THE PRESENCE OF A VERTEBRATE BAR CAPACITY 300 kg				

VERTEBRATE BAR

9	ART.	bar H mm	
	M 00 V030 00 00 00 00	300	
	M 00 V050 00 00 00 00	500	
	M 00 V060 00 00 00 00	600	
	M 00 V070 00 00 00 00	700	
	M 00 V075 00 00 00 00	750	
	M 00 V090 00 00 00 00	900	
	M 00 V105 00 00 00 00	1050	
	M 00 V122 00 00 00 00	1225	
	M 00 V140 00 00 00 00	1400	
	M 00 V152 00 00 00 00	1525	
	M 00 V190 00 00 00 00	1900	

It is necessary to fit an anti-tilt rod if drawers or extension shelves are installed

CYLINDER CLOSURE (KEY)

10	ART.		
	M 32 V000 C0 00 00 00	C0	cylinder lock with different numbering
	M 32 V000 C1 00 00 00	C1	cylinder lock for sets of 160 numbers
	M 32 V000 C2 00 00 00	C2	cylinder lock for same numbering

COMPLETE WITH: 1 cylinder lock with 2 keys, 1 steel wire with sheath, 1 front pin assembly, 1 back pin assembly



KEY LOCK
cylinder closure "C0" supplied as standard.
see master section, page 31



LOCK WITH DIGITAL CODE (CODE)

11	ART.		
	M 32 V000 E2 00 00 00	E2	bar opening/closing
	M 32 V000 T2 00 00 00	T2	door+bar opening/closing

ART. REMOTE CONTROL

M 00 VRC0 00 00 00 00	Receiver module with remote control
M 00 VRC0 00 00 01 00	Additional remote control

REAR PANEL

12	ART.		Dim. mm	
	M 30 W100 P0 00 00 _ _		713x1000 H	
	M 30 W150 P0 00 00 _ _		713x1500 H	
	M 30 W200 P0 00 00 _ _		713x2000 H	
	M 30 W225 P0 00 00 _ _		713x2250 H	
	M 30 W250 P0 00 00 _ _		713x2500 H	
	M 30 W300 P0 00 00 _ _		713x3000 H	

A back panel must be fitted to each third bay

SIDE PANEL

13	ART.		Dim. mm	
	M 02 W100 L0 00 00 _ _		18x572x1000 H	
	M 02 W125 L0 00 00 _ _		18x572x1250 H	
	M 02 W150 L0 00 00 _ _		18x572x1500 H	

CROSS BRACINGS

14	ART.		For shelves height	
	M 30 X150 00 00 00 _ _		1500/2250	
	M 30 X250 00 00 00 _ _		2500/3000	

A cross bracing must be fitted to each third bay

SYSTEM SR-MASTER



15

FLEXIBLE EXTENSION DRAWERS

ART. WHIT Dark Grey plastic kit	ART. NO plastic kit*	Usable dim. mm	Front H mm	kg	
M 32 C050 0110 OF __	M 32 C050 0100 OF __	600x447x31 H	50	50 - 75 - 100	100% - 96% - 92%
M 32 C075 0110 OF __	M 32 C075 0100 OF __	600x447x56 H	75	50 - 75 - 100	100% - 96% - 92%
M 32 C100 0110 OF __	M 32 C100 0100 OF __	600x447x81 H	100	50 - 75 - 100	100% - 96% - 92%
M 32 C125 0110 OF __	M 32 C125 0100 OF __	600x447x106 H	125	50 - 75 - 100	100% - 96% - 92%
M 32 C150 0110 OF __	M 32 C150 0100 OF __	600x447x131 H	150	50 - 75 - 100	100% - 96% - 92%
M 32 C200 0110 OF __	M 32 C200 0100 OF __	600x447x181 H	200	50 - 75 - 100	100% - 96% - 92%
M 32 C250 0110 OF __	M 32 C250 0100 OF __	600x447x231 H	250	50 - 75 - 100	100% - 96% - 92%
M 32 C300 0110 OF __	M 32 C300 0100 OF __	600x447x281 H	300	50 - 75 - 100	100% - 96% - 92%

*MATCH THE ITEM NUMBER TO ONE OF THE PLASTIC KITS AVAILABLE IN THE TABLE BELOW



16

TELESCOPIC EXTRACTION DRAWERS

ART. WHIT Dark Grey plastic kity	ART. NO plastic kit*	Usable dim. mm	Front H mm	kg	
M 32 C075 0110 OT __	M 32 C075 0100 OT __	600x447x56 H	75	200	100%
M 32 C100 0110 OT __	M 32 C100 0100 OT __	600x447x81 H	100	200	100%
M 32 C125 0110 OT __	M 32 C125 0100 OT __	600x447x106 H	125	200	100%
M 32 C150 0110 OT __	M 32 C150 0100 OT __	600x447x131 H	150	200	100%
M 32 C200 0110 OT __	M 32 C200 0100 OT __	600x447x181 H	200	200	100%
M 32 C250 0110 OT __	M 32 C250 0100 OT __	600x447x231 H	250	200	100%
M 32 C300 0110 OT __	M 32 C300 0100 OT __	600x447x281 H	300	200	100%

*MATCH THE ITEM NUMBER TO ONE OF THE PLASTIC KITS AVAILABLE IN THE TABLE BELOW

PLASTIC KIT FOR DRAWERS AND RETRACTABLE SHELVES



PLASTIC COLOURS	ART.
MEDITERRANEAN BLUE	M 30 PLS1 00 00 00 M1
SKY BLUE	M 30 PLS1 00 00 00 M2
GLAMOUR RED	M 30 PLS1 00 00 00 M3
RED CARPET	M 30 PLS1 00 00 00 M4
JUICY ORANGE	M 30 PLS1 00 00 00 M5
SUNNY YELLOW	M 30 PLS1 00 00 00 M6
FOREST GREEN	M 30 PLS1 00 00 00 M7



17

FLEXIBLE EXTENSIBLE SHELVES

ART. WHIT Dark Grey plastic kit	ART. NO plastic kit*	Usable dim. mm	Front H mm	kg	
M 32 C057 0110 0F _ _	M 32 C057 0100 0F _ _	600x447	70	50 - 75 - 100	100% - 96% - 92%

*MATCH THE ITEM NUMBER TO ONE OF THE PLASTIC KITS AVAILABLE IN THE TABLE ON THE LEFT



18

TELESCOPIC EXTENSIBLE SHELVES

ART. WHIT Dark Grey plastic kit	ART. NO plastic kit*	Usable dim. mm	Front H mm	kg	
M 32 C057 0110 0T _ _	M 32 C057 0100 0T _ _	600x447	70	200	100%

*MATCH THE ITEM NUMBER TO ONE OF THE PLASTIC KITS AVAILABLE IN THE TABLE ON THE LEFT

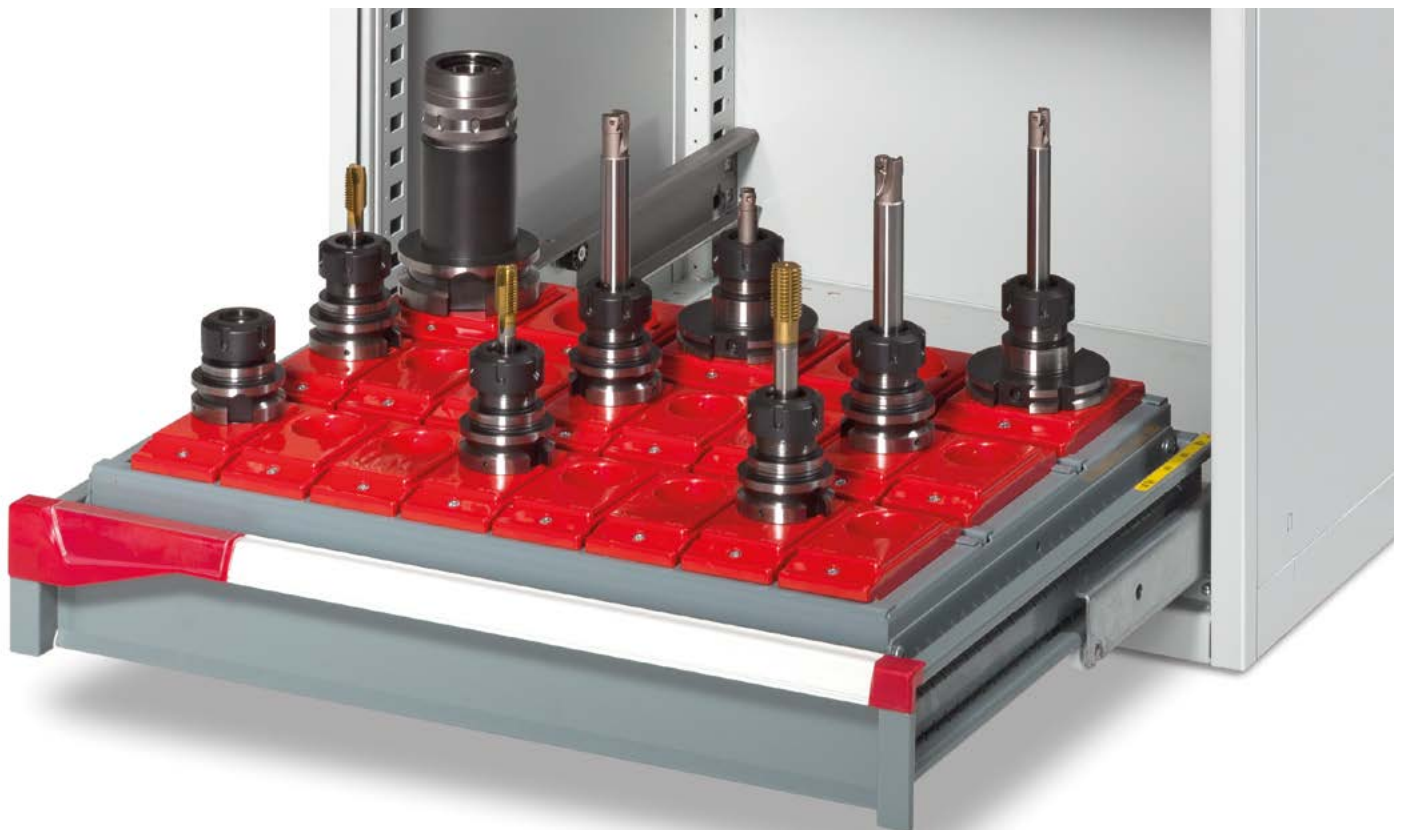

NC TOOL HOLDER ACCESSORIES
see page 591

SYSTEM SR-MASTER

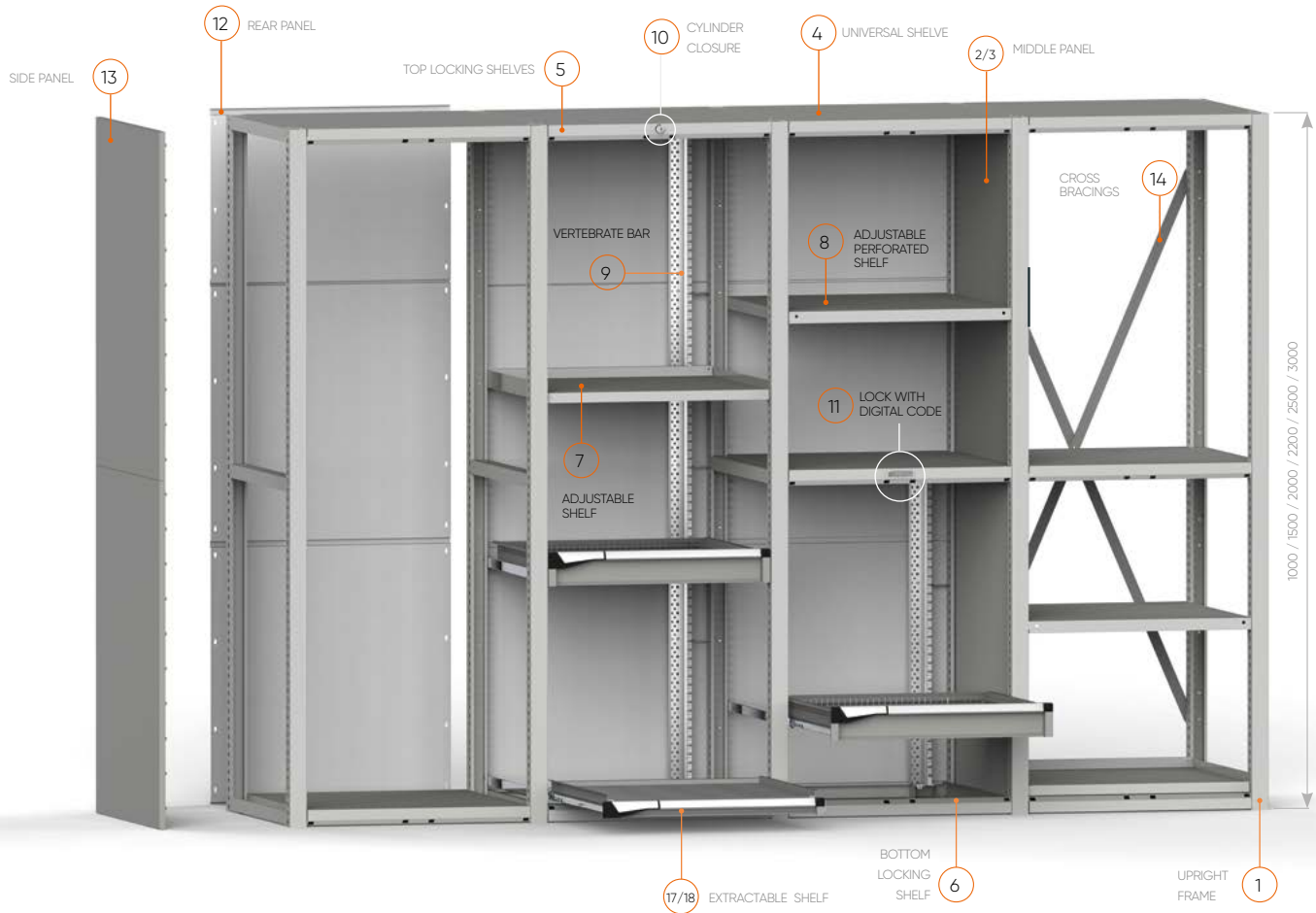

METAL COLOURS

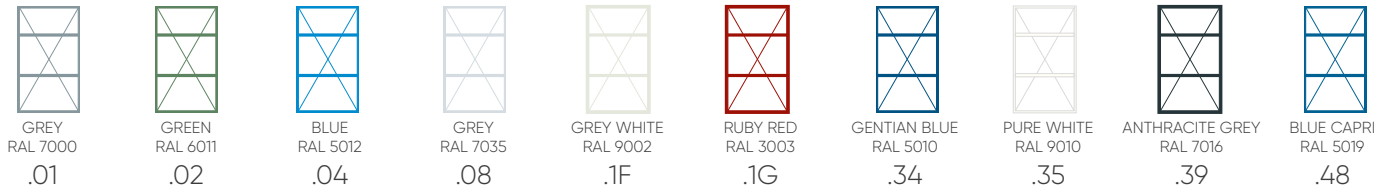

UPRIGHT FRAMES

1	ART.	Dim. mm
	M 02 F100 00 00 01	51x573x1000 H
	M 02 F150 00 00 01	51x573x1500 H
	M 02 F200 00 00 01	51x573x2000 H
	M 02 F225 00 00 01	51x573x2250 H
	M 02 F250 00 00 01	51x573x2500 H
	M 02 F300 00 00 01	51x573x3000 H

COMPLETE WITH CLOSING CAPS

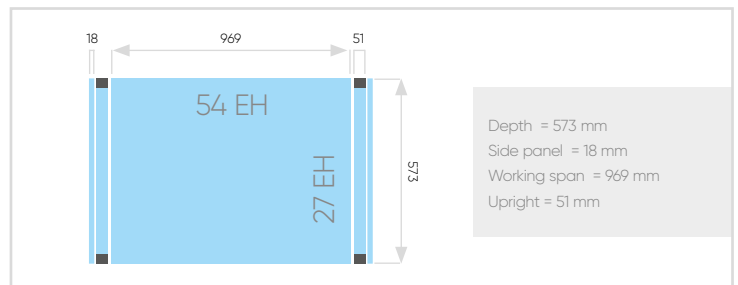

2 BOTTOM WALL

3 TOP WALL

MIDDLE PANELS

H side	ART.	Dim. mm H	ART.	Dim. mm H
1000	-	1000	-	-
1500	-	1500	-	-
2000	M 02 W100 MO 20 00	1000	M 02 W100 MO 10 00	1000
2250	M 02 W100 MO 20 00	1000	M 02 W125 MO 10 00	1250
2500	M 02 W100 MO 20 00	1000	M 02 W150 MO 10 00	1500
3000	M 02 W100 MO 20 00	1000	M 02 W100 MO 10 00*	1000

*For the 3000 mm height, two top middle walls are required to seal the side

UNIVERSAL SHELVES

4	ART.		Dim. mm	
	M 52 PT46 00 10 00	__	969x571x46 H	
CAPACITY 250 kg				

TOP LOCKING SHELVES

5	ART.		Dim. mm	
	M 52 PS46 00 10 00	__	969x571x46 H	
CAPACITY 150 kg				

BOTTOM LOCKING SHELVES

6	ART.		Dim. mm	
	M 52 PS46 10 10 00	__	969x571x46 H	
CAPACITY 150 kg				

ADJUSTABLE SHELF

7	ART.		Dim. mm	
	M 52 PR25 00 00 01	__	963x478x60 H	
CAN BE FITTED FRONTALLY TO THE VERTEBRATE BAR CAPACITY 100 kg				

ADJUSTABLE PERFORATED SHELF

8	ART.		Dim. mm	
	M 52 PR35 10 00 01	__	969x568x35 H	
MAY NOT BE INSERTED IN THE PRESENCE OF A VERTEBRATE BAR CAPACITY 300 kg				

VERTEBRATE BAR

9	ART.	bar H mm	
	M 00 V030 00 00 00 00	300	
	M 00 V050 00 00 00 00	500	
	M 00 V060 00 00 00 00	600	
	M 00 V070 00 00 00 00	700	
	M 00 V075 00 00 00 00	750	
	M 00 V090 00 00 00 00	900	
	M 00 V105 00 00 00 00	1050	
	M 00 V122 00 00 00 00	1225	
	M 00 V140 00 00 00 00	1400	
	M 00 V152 00 00 00 00	1525	
	M 00 V190 00 00 00 00	1900	

It is necessary to fit an anti-tilt rod if drawers or extension shelves are installed

CYLINDER CLOSURE (KEY)

10	ART.		
	M 52 V000 C0 00 00 00	C0	cylinder lock with different numbering
	M 52 V000 C1 00 00 00	C1	cylinder lock for sets of 160 numbers
	M 52 V000 C2 00 00 00	C2	cylinder lock for same numbering

COMPLETE WITH: 1 cylinder lock with 2 keys, 1 steel wire with sheath, 1 front pin assembly, 1 back pin assembly



KEY LOCK
Cylinder closure "C0" supplied as standard.
See Master section, page 31



LOCK WITH DIGITAL CODE (CODE)

11	ART.		
	M 52 V000 E2 00 00 00	E2	bar opening/closing
	M 52 V000 T2 00 00 00	T2	door+bar opening/closing

ART. REMOTE CONTROL

M 00 VRC0 00 00 00 00	Receiver module with remote control
M 00 VRC0 00 00 01 00	Additional remote control

REAR PANEL

12	ART.		Dim. mm	
	M 50 W100 P0 00 00	__	1019x1000 H	
	M 50 W150 P0 00 00	__	1019x1500 H	
	M 50 W200 P0 00 00	__	1019x2000 H	
	M 50 W225 P0 00 00	__	1019x2250 H	
	M 50 W250 P0 00 00	__	1019x2500 H	
	M 50 W300 P0 00 00	__	1019x3000 H	

A back panel must be fitted to each third bay

SIDE PANEL

13	ART.		Dim. mm	
	M 02 W100 L0 00 00	__	18x572x1000 H	
	M 02 W125 L0 00 00	__	18x572x1250 H	
	M 02 W150 L0 00 00	__	18x572x1500 H	

CROSS BRACINGS

14	ART.		For shelves height	
	M 50 X150 00 00 00	__	1500/2250	
	M 50 X250 00 00 00	__	2500/3000	

A cross bracing must be fitted to each third bay

SYSTEM SR-MASTER



15

FLEXIBLE EXTENSION DRAWERS

ART. WHIT Dark Grey plastic kit	ART. NO plastic kit*	Usable dim. mm	Front H mm	kg	
M 52 C050 0110 OF __	M 52 C050 0100 OF __	906x447x31 H	50	50 - 75 - 100	100% - 96% - 92%
M 52 C075 0110 OF __	M 52 C075 0100 OF __	906x447x56 H	75	50 - 75 - 100	100% - 96% - 92%
M 52 C100 0110 OF __	M 52 C100 0100 OF __	906x447x81 H	100	50 - 75 - 100	100% - 96% - 92%
M 52 C125 0110 OF __	M 52 C125 0100 OF __	906x447x106 H	125	50 - 75 - 100	100% - 96% - 92%
M 52 C150 0110 OF __	M 52 C150 0100 OF __	906x447x131 H	150	50 - 75 - 100	100% - 96% - 92%
M 52 C200 0110 OF __	M 52 C200 0100 OF __	906x447x181 H	200	50 - 75 - 100	100% - 96% - 92%
M 52 C250 0110 OF __	M 52 C250 0100 OF __	906x447x231 H	250	50 - 75 - 100	100% - 96% - 92%
M 52 C300 0110 OF __	M 52 C300 0100 OF __	906x447x281 H	300	50 - 75 - 100	100% - 96% - 92%

*MATCH THE ITEM NUMBER TO ONE OF THE PLASTIC KITS AVAILABLE IN THE TABLE BELOW



16

TELESCOPIC EXTRACTION DRAWERS

ART. WHIT Dark Grey plastic kit	ART. NO plastic kit*	Usable dim. mm	Front H mm	kg	
M 52 C075 0110 OT __	M 52 C075 0100 OT __	906x447x56 H	75	200	100%
M 52 C100 0110 OT __	M 52 C100 0100 OT __	906x447x81 H	100	200	100%
M 52 C125 0110 OT __	M 52 C125 0100 OT __	906x447x106 H	125	200	100%
M 52 C150 0110 OT __	M 52 C150 0100 OT __	906x447x131 H	150	200	100%
M 52 C200 0110 OT __	M 52 C200 0100 OT __	906x447x181 H	200	200	100%
M 52 C250 0110 OT __	M 52 C250 0100 OT __	906x447x231 H	250	200	100%
M 52 C300 0110 OT __	M 52 C300 0100 OT __	906x447x281 H	300	200	100%

*MATCH THE ITEM NUMBER TO ONE OF THE PLASTIC KITS AVAILABLE IN THE TABLE BELOW

PLASTIC KIT FOR DRAWERS AND RETRACTABLE SHELVES



PLASTIC COLOURS	ART.
MEDITERRANEAN BLUE	M 50 PLS1 00 00 00 M1
SKY BLUE	M 50 PLS1 00 00 00 M2
GLAMOUR RED	M 50 PLS1 00 00 00 M3
RED CARPET	M 50 PLS1 00 00 00 M4
JUICY ORANGE	M 50 PLS1 00 00 00 M5
SUNNY YELLOW	M 50 PLS1 00 00 00 M6
FOREST GREEN	M 50 PLS1 00 00 00 M7



17

FLEXIBLE EXTENSIBLE SHELVES

ART. WHIT Dark Grey plastic kit	ART. NO plastic kit*	Usable dim. mm	Front H mm	kg	
M 52 C057 0110 0F _ _	M 52 C057 0100 0F _ _	906x447	70	50 - 75 - 100	100% - 96% - 92%

*MATCH THE ITEM NUMBER TO ONE OF THE PLASTIC KITS AVAILABLE IN THE TABLE ON THE LEFT



18

TELESCOPIC EXTENSIBLE SHELVES

ART. WHIT Dark Grey plastic kit	ART. NO plastic kit*	Usable dim. mm	Front H mm	kg	
M 52 C057 0110 0T _ _	M 52 C057 0100 0T _ _	906x447	70	200	100%

*MATCH THE ITEM NUMBER TO ONE OF THE PLASTIC KITS AVAILABLE IN THE TABLE ON THE LEFT



NC TOOL HOLDER ACCESSORIES
see page 614

SYSTEM SR-MASTER



P

N

M



SYSTEM SR-MASTER

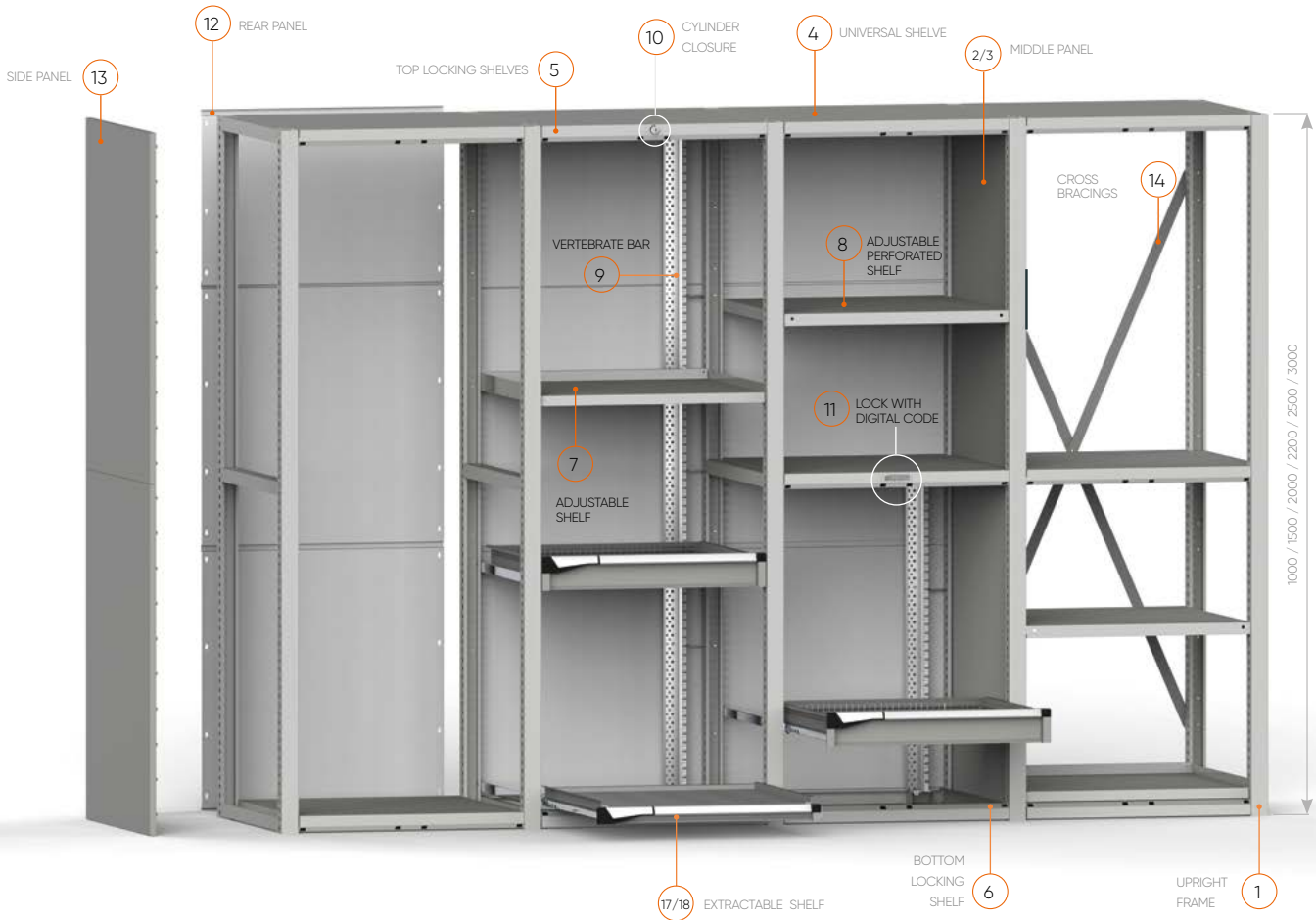

METAL COLOURS

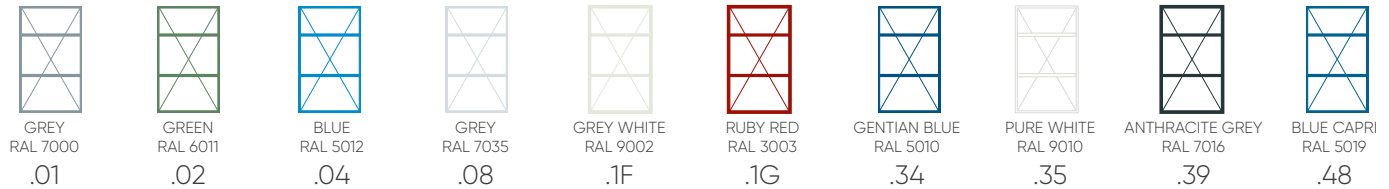

UPRIGHT FRAMES

1	ART.	Dim. mm
	M 03 F100 00 00 01	51x726x1000 H
	M 03 F150 00 00 01	51x726x1500 H
	M 03 F200 00 00 01	51x726x2000 H
	M 03 F225 00 00 01	51x726x2250 H
	M 03 F250 00 00 01	51x726x2500 H
	M 03 F300 00 00 01	51x726x3000 H

COMPLETE WITH CLOSING CAPS

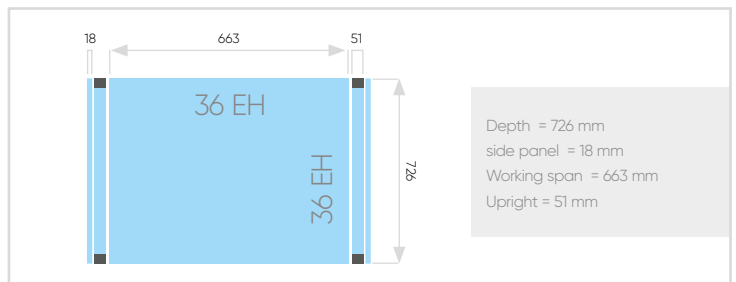

2 BOTTOM WALL

H side	ART.	Dim. mm H
1000	-	1000
1500	-	1500
2000	M 03 W100 MO 20 00	1000
2250	M 03 W100 MO 20 00	1000
2500	M 03 W100 MO 20 00	1000
3000	M 03 W100 MO 20 00	1000

3 TOP WALL

ART.	Dim. mm H
-	-
-	-
M 03 W100 MO 10 00	1000
M 03 W125 MO 10 00	1250
M 03 W150 MO 10 00	1500
M 03 W100 MO 10 00	1000

MIDDLE PANELS

*For the 3000 mm height, two top middle walls are required to seal the side

UNIVERSAL SHELF

4	ART.		Dim. mm	
	M 33 PT46 00 10 00		663x724x46 H	
CAPACITY 250 kg				

TOP LOCKING SHELVES

5	ART.		Dim. mm	
	M 33 PS46 00 10 00		663x724x46 H	
CAPACITY 150 kg				

BOTTOM LOCKING SHELVES

6	ART.		Dim. mm	
	M 33 PS46 10 10 00		663x724x46 H	
CAPACITY 150 kg				

ADJUSTABLE SHELF

7	ART.		Dim. mm	
	M 33 PR25 00 00 01		657x631x60 H	
CAN BE FITTED FRONTALLY TO THE VERTEBRATE BAR CAPACITY 150 kg				

ADJUSTABLE PERFORATED SHELF

8	ART.		Dim. mm	
	M 33 PR35 10 00 01		663x721x35 H	
MAY NOT BE INSERTED IN THE PRESENCE OF A VERTEBRATE BAR CAPACITY 300 kg				

VERTEBRATE BAR

9	ART.	bar H mm	
	M 00 V030 00 00 00 00	300	
	M 00 V050 00 00 00 00	500	
	M 00 V060 00 00 00 00	600	
	M 00 V070 00 00 00 00	700	
	M 00 V075 00 00 00 00	750	
	M 00 V090 00 00 00 00	900	
	M 00 V105 00 00 00 00	1050	
	M 00 V122 00 00 00 00	1225	
	M 00 V140 00 00 00 00	1400	
	M 00 V152 00 00 00 00	1525	
	M 00 V190 00 00 00 00	1900	

It is necessary to fit an anti-tilt rod if drawers or extension shelves are installed

CYLINDER CLOSURE (KEY)

10	ART.		
	M 33 V000 C0 00 00 00	C0	cylinder lock with different numbering
	M 33 V000 C1 00 00 00	C1	cylinder lock for sets of 160 numbers
	M 33 V000 C2 00 00 00	C2	cylinder lock for same numbering

COMPLETE WITH: 1 cylinder lock with 2 keys, 1 steel wire with sheath, 1 front pin assembly, 1 back pin assembly



KEY LOCK
Cylinder closure "C0" supplied as standard.
See Master section, page 31



LOCK WITH DIGITAL CODE (CODE)

11	ART.		
	M 33 V000 E2 00 00 00	E2	bar opening/closing
	M 33 V000 T2 00 00 00	T2	door+bar opening/closing

ART. REMOTE CONTROL

M 00 VRC0 00 00 00 00	Receiver module with remote control
M 00 VRC0 00 00 01 00	Additional remote control

REAR PANEL

12	ART.		Dim. mm	
	M 30 W100 P0 00 00		713x1000 H	
	M 30 W150 P0 00 00		713x1500 H	
	M 30 W200 P0 00 00		713x2000 H	
	M 30 W225 P0 00 00		713x2250 H	
	M 30 W250 P0 00 00		713x2500 H	
	M 30 W300 P0 00 00		713x3000 H	

A back panel must be fitted to each third bay

SIDE PANEL

13	ART.		Dim. mm	
	M 03 W100 L0 00 00		18x725x1000 H	
	M 03 W125 L0 00 00		18x725x1250 H	
	M 03 W150 L0 00 00		18x725x1500 h	

CROSS BRACINGS

14	ART.		For shelves height	
	M 30 X150 00 00 00		1500/2250	
	M 30 X250 00 00 00		2500/3000	

A cross bracing must be fitted to each third bay

SYSTEM SR-MASTER



15

FLEXIBLE EXTENSION DRAWERS

ART. WHIT Dark Grey plastic kit	ART. NO plastic kit*	Usable dim. mm	Front H mm	kg	
M 33 C050 0110 OF __	M 33 C050 0100 OF __	600x600x31 H	50	50 - 75 - 100	100% - 96% - 92%
M 33 C075 0110 OF __	M 33 C075 0100 OF __	600x600x56 H	75	50 - 75 - 100	100% - 96% - 92%
M 33 C100 0110 OF __	M 33 C100 0100 OF __	600x600x81 H	100	50 - 75 - 100	100% - 96% - 92%
M 33 C125 0110 OF __	M 33 C125 0100 OF __	600x600x106 H	125	50 - 75 - 100	100% - 96% - 92%
M 33 C150 0110 OF __	M 33 C150 0100 OF __	600x600x131 H	150	50 - 75 - 100	100% - 96% - 92%
M 33 C200 0110 OF __	M 33 C200 0100 OF __	600x600x181 H	200	50 - 75 - 100	100% - 96% - 92%
M 33 C250 0110 OF __	M 33 C250 0100 OF __	600x600x231 H	250	50 - 75 - 100	100% - 96% - 92%
M 33 C300 0110 OF __	M 33 C300 0100 OF __	600x600x281 H	300	50 - 75 - 100	100% - 96% - 92%

*MATCH THE ITEM NUMBER TO ONE OF THE PLASTIC KITS AVAILABLE IN THE TABLE BELOW



16

TELESCOPIC EXTRACTION DRAWERS

ART. WHIT Dark Grey plastic kit	ART. NO plastic kit*	Usable dim. mm	Front H mm	kg	
M 33 C075 0110 OT __	M 33 C075 0100 OT __	600x600x56 H	75	200	100%
M 33 C100 0110 OT __	M 33 C100 0100 OT __	600x600x81 H	100	200	100%
M 33 C125 0110 OT __	M 33 C125 0100 OT __	600x600x106 H	125	200	100%
M 33 C150 0110 OT __	M 33 C150 0100 OT __	600x600x131 H	150	200	100%
M 33 C200 0110 OT __	M 33 C200 0100 OT __	600x600x181 h	200	200	100%
M 33 C250 0110 OT __	M 33 C250 0100 OT __	600x600x231 H	250	200	100%
M 33 C300 0110 OT __	M 33 C300 0100 OT __	600x600x281 H	300	200	100%

*MATCH THE ITEM NUMBER TO ONE OF THE PLASTIC KITS AVAILABLE IN THE TABLE BELOW

PLASTIC KIT FOR DRAWERS AND RETRACTABLE SHELVES



PLASTIC COLOURS	ART.
MEDITERRANEAN BLUE	M 30 PLS1 00 00 00 M1
SKY BLUE	M 30 PLS1 00 00 00 M2
GLAMOUR RED	M 30 PLS1 00 00 00 M3
RED CARPET	M 30 PLS1 00 00 00 M4
JUICY ORANGE	M 30 PLS1 00 00 00 M5
SUNNY YELLOW	M 30 PLS1 00 00 00 M6
FOREST GREEN	M 30 PLS1 00 00 00 M7



17

FLEXIBLE EXTENSIBLE SHELVES

ART. WHIT Dark Grey plastic kit	ART. NO plastic kit*	Usable dim. mm	Front H mm	kg	
M 33 C057 0110 0F _ _	M 33 C057 0100 0F _ _	600x600	70	50 - 75 - 100	100% - 96% - 92%

*MATCH THE ITEM NUMBER TO ONE OF THE PLASTIC KITS AVAILABLE IN THE TABLE ON THE LEFT



18

TELESCOPIC EXTENSIBLE SHELVES

ART. WHIT Dark Grey plastic kit	ART. NO plastic kit*	Usable dim. mm	Front H mm	kg	
M 33 C057 0110 0T _ _	M 33 C057 0100 0T _ _	600x600	70	200	100%

*MATCH THE ITEM NUMBER TO ONE OF THE PLASTIC KITS AVAILABLE IN THE TABLE ON THE LEFT



NC TOOL HOLDER ACCESSORIES
see page 614

SYSTEM SR-MASTER

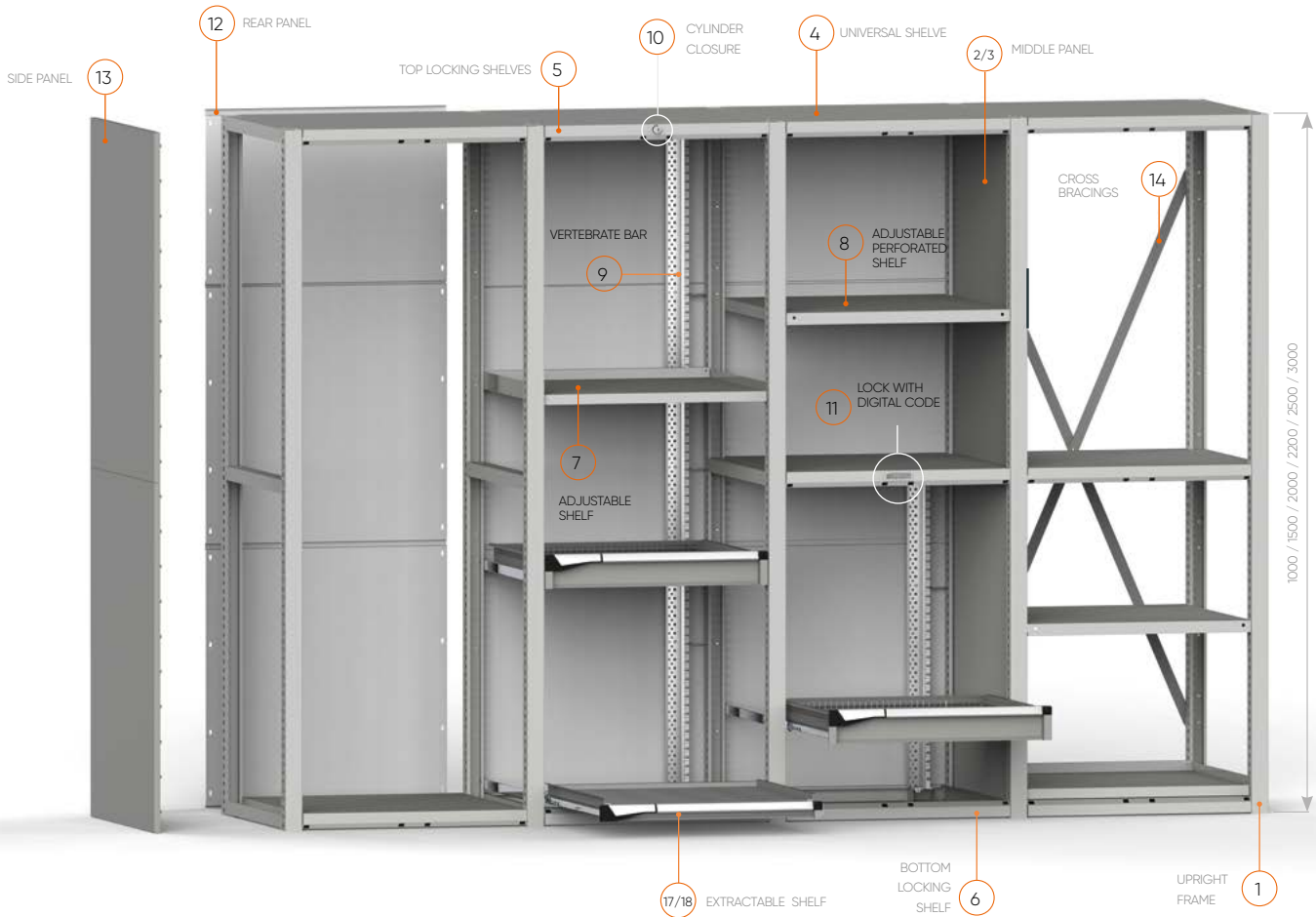

METAL COLOURS

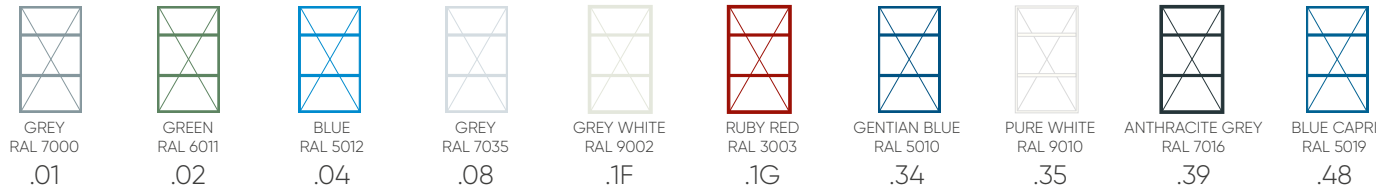

UPRIGHT FRAMES

1	ART.	Dim. mm
	M 03 F100 00 00 01	51x726x1000 H
	M 03 F150 00 00 01	51x726x1500 H
	M 03 F200 00 00 01	51x726x2000 H
	M 03 F225 00 00 01	51x726x2250 H
	M 03 F250 00 00 01	51x726x2500 H
	M 03 F300 00 00 01	51x726x3000 H

COMPLETE WITH CLOSING CAPS

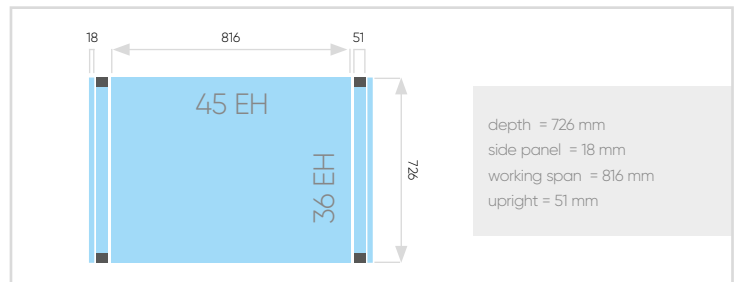

2 BOTTOM WALL

H side	ART.	Dim. mm H
1000	-	-
1500	-	-
2000	M 03 W100 M0 20 00	1000
2250	M 03 W100 M0 20 00	1000
2500	M 03 W100 M0 20 00	1000
3000	M 03 W100 M0 20 00	1000

3 TOP WALL

ART.	Dim. mm H
-	-
-	-
M 03 W100 M0 10 00	1000
M 03 W125 M0 10 00	1250
M 03 W150 M0 10 00	1500
M 03 W100 M0 10 00*	1000

*For the 3000 mm height, two top middle walls are required to seal the side

UNIVERSAL SHELF

4	ART.		Dim. mm	
	M 43 PT46 00 10 00		816x724x46 H	
CAPACITY 250 kg				

TOP LOCKING SHELVES

5	ART.		Dim. mm	
	M 43 PS46 00 10 00		816x724x46 H	
CAPACITY 150 kg				

BOTTOM LOCKING SHELVES

6	ART.		Dim. mm	
	M 43 PS46 10 10 00		816x724x46 H	
CAPACITY 150 kg				

ADJUSTABLE SHELF

7	ART.		Dim. mm	
	M 43 PR25 00 00 01		810x631x60 H	
CAN BE FITTED FRONTALLY TO THE VERTEBRATE BAR CAPACITY 100 kg				

ADJUSTABLE PERFORATED SHELF

8	ART.		Dim. mm	
	M 43 PR35 10 00 01		816x721x35 H	
MAY NOT BE INSERTED IN THE PRESENCE OF A VERTEBRATE BAR CAPACITY 200 kg				

VERTEBRATE BAR

9	ART.	bar H mm	
	M 00 V030 00 00 00 00	300	
	M 00 V050 00 00 00 00	500	
	M 00 V060 00 00 00 00	600	
	M 00 V070 00 00 00 00	700	
	M 00 V075 00 00 00 00	750	
	M 00 V090 00 00 00 00	900	
	M 00 V105 00 00 00 00	1050	
	M 00 V122 00 00 00 00	1225	
	M 00 V140 00 00 00 00	1400	
	M 00 V152 00 00 00 00	1525	
	M 00 V190 00 00 00 00	1900	

It is necessary to fit an anti-tilt rod if drawers or extension shelves are installed



CYLINDER CLOSURE (KEY)

10	ART.		
	M 43 V000 C0 00 00 00	C0	cylinder lock with different numbering
	M 43 V000 C1 00 00 00	C1	cylinder lock for sets of 160 numbers
	M 43 V000 C2 00 00 00	C2	cylinder lock for same numbering

COMPLETE WITH: 1 cylinder lock with 2 keys, 1 steel wire with sheath, 1 front pin assembly, 1 back pin assembly



KEY LOCK
Cylinder closure "C0" supplied as standard.
See Master section, page 31



LOCK WITH DIGITAL CODE (CODE)

11	ART.		
	M 43 V000 E2 00 00 00	E2	bar opening/closing
	M 43 V000 T2 00 00 00	T2	door+bar opening/closing

ART. REMOTE CONTROL

M 00 VRC0 00 00 00 00	Receiver module with remote control
M 00 VRC0 00 00 01 00	Additional remote control

REAR PANEL

12	ART.		Dim. mm	
	M 40 W100 P0 00 00		866x1000 H	
	M 40 W150 P0 00 00		866x1500 H	
	M 40 W200 P0 00 00		866x2000 H	
	M 40 W225 P0 00 00		866x2250 H	
	M 40 W250 P0 00 00		866x2500 H	
	M 40 W300 P0 00 00		866x3000 H	

A back panel must be fitted to each third bay

SIDE PANEL

13	ART.		Dim. mm	
	M 03 W100 L0 00 00		18x725x1000 H	
	M 03 W125 L0 00 00		18x725x1250 H	
	M 03 W150 L0 00 00		18x725x1500 H	

CROSS BRACINGS

14	ART.		For shelves height	
	M 40 X150 00 00 00		1500/2250	
	M 40 X250 00 00 00		2500/3000	

A cross bracing must be fitted to each third bay

SYSTEM SR-MASTER



15

FLEXIBLE EXTENSION DRAWERS

ART. WHIT Dark Grey plastic kit	ART. NO plastic kit*	Usable dim. mm	Front H mm	kg	
M 43 C050 0110 OF __	M 43 C050 0100 OF __	753x600x31 H	50	50 - 75 - 100	100% - 96% - 92%
M 43 C075 0110 OF __	M 43 C075 0100 OF __	753x600x56 H	75	50 - 75 - 100	100% - 96% - 92%
M 43 C100 0110 OF __	M 43 C100 0100 OF __	753x600x81 H	100	50 - 75 - 100	100% - 96% - 92%
M 43 C125 0110 OF __	M 43 C125 0100 OF __	753x600x106 H	125	50 - 75 - 100	100% - 96% - 92%
M 43 C150 0110 OF __	M 43 C150 0100 OF __	753x600x131 H	150	50 - 75 - 100	100% - 96% - 92%
M 43 C200 0110 OF __	M 43 C200 0100 OF __	753x600x181 H	200	50 - 75 - 100	100% - 96% - 92%
M 43 C250 0110 OF __	M 43 C250 0100 OF __	753x600x231 H	250	50 - 75 - 100	100% - 96% - 92%
M 43 C300 0110 OF __	M 43 C300 0100 OF __	753x600x281 H	300	50 - 75 - 100	100% - 96% - 92%

*MATCH THE ITEM NUMBER TO ONE OF THE PLASTIC KITS AVAILABLE IN THE TABLE BELOW



16

TELESCOPIC EXTRACTION DRAWERS

ART. WHIT Dark Grey plastic kit	ART. NO plastic kit*	Usable dim. mm	Front H mm	kg	
M 43 C075 0110 OT __	M 43 C075 0100 OT __	753x600x56 H	75	200	100%
M 43 C100 0110 OT __	M 43 C100 0100 OT __	753x600x81 H	100	200	100%
M 43 C125 0110 OT __	M 43 C125 0100 OT __	753x600x106 H	125	200	100%
M 43 C150 0110 OT __	M 43 C150 0100 OT __	753x600x131 H	150	200	100%
M 43 C200 0110 OT __	M 43 C200 0100 OT __	753x600x181 H	200	200	100%
M 43 C250 0110 OT __	M 43 C250 0100 OT __	753x600x231 H	250	200	100%
M 43 C300 0110 OT __	M 43 C300 0100 OT __	753x600x281 H	300	200	100%

*MATCH THE ITEM NUMBER TO ONE OF THE PLASTIC KITS AVAILABLE IN THE TABLE BELOW

PLASTIC KIT FOR DRAWERS AND RETRACTABLE SHELVES



PLASTIC COLOURS	ART.
MEDITERRANEAN BLUE	M 40 PLS1 00 00 00 M1
SKY BLUE	M 40 PLS1 00 00 00 M2
GLAMOUR RED	M 40 PLS1 00 00 00 M3
RED CARPET	M 40 PLS1 00 00 00 M4
JUICY ORANGE	M 40 PLS1 00 00 00 M5
SUNNY YELLOW	M 40 PLS1 00 00 00 M6
FOREST GREEN	M 40 PLS1 00 00 00 M7



17

FLEXIBLE EXTENSIBLE SHELVES

ART. WHIT Dark Grey plastic kit	ART. NO plastic kit*	Usable dim. mm	Front H mm	kg	
M43 C057 0110 OF _ _	M43 C057 0100 OF _ _	753x600	70	50 - 75 - 100	100% - 96% - 92%

*MATCH THE ITEM NUMBER TO ONE OF THE PLASTIC KITS AVAILABLE IN THE TABLE ON THE LEFT



18

TELESCOPIC EXTENSIBLE SHELVES

ART. WHIT Dark Grey plastic kit	ART. NO plastic kit*	Usable dim. mm	Front H mm	kg	
M43 C057 0110 OT _ _	M43 C057 0100 OT _ _	753x600	70	200	100%

*MATCH THE ITEM NUMBER TO ONE OF THE PLASTIC KITS AVAILABLE IN THE TABLE ON THE LEFT



SYSTEM SR-MASTER

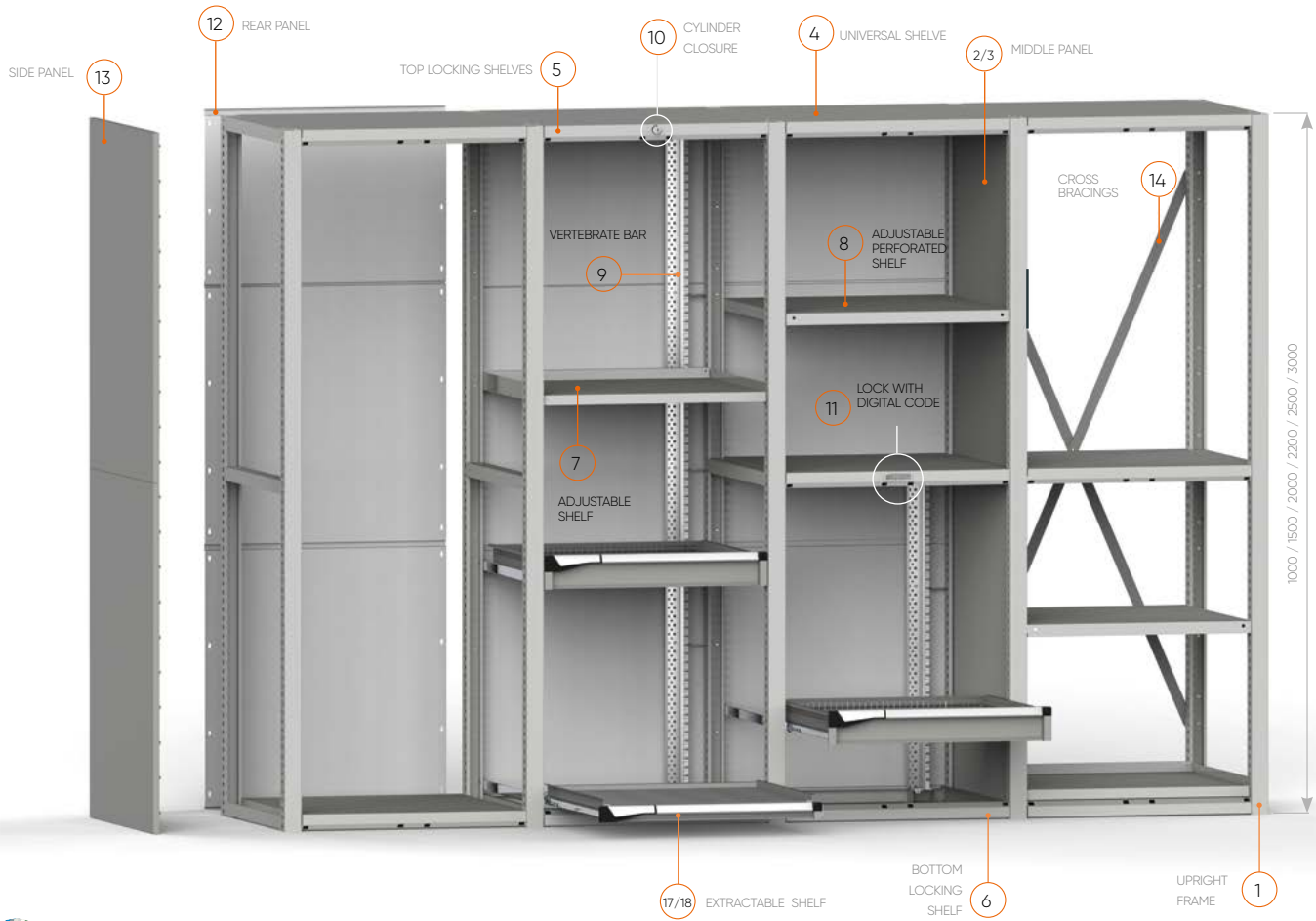

METAL COLOUR

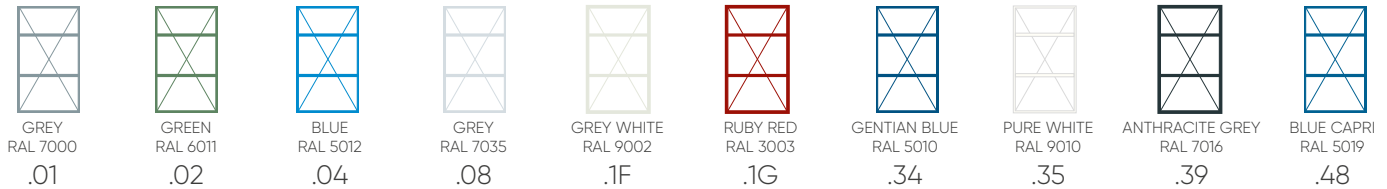

UPRIGHT FRAMES

1	ART.	Dim. mm
	M 03 F100 00 00 01	51x726x1000 H
	M 03 F150 00 00 01	51x726x1500 H
	M 03 F200 00 00 01	51x726x2000 H
	M 03 F225 00 00 01	51x726x2250 H
	M 03 F250 00 00 01	51x726x2500 H
	M 03 F300 00 00 01	51x726x3000 H

COMPLETE WITH CLOSING CAPS

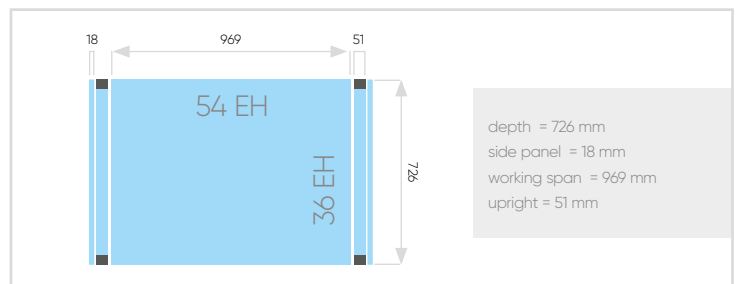

2 BOTTOM WALL

H side	ART.	Dim. mm H
1000	-	1000
1500	-	1500
2000	M 03 W100 MO 20 00	1000
2250	M 03 W100 MO 20 00	1000
2500	M 03 W100 MO 20 00	1000
3000	M 03 W100 MO 20 00	1000

3 TOP WALL

ART.	Dim. mm H
-	-
-	-
M 03 W100 MO 10 00	1000
M 03 W125 MO 10 00	1250
M 03 W150 MO 10 00	1500
M 03 W100 MO 10 00*	1000

*For the 3000 mm height, two top middle walls are required to seal the side

MIDDLE PANELS

UNIVERSAL SHELF

4	ART.		Dim. mm	
	M 53 PT46 00 10 00	--	969x724x46 H	
CAPACITY 250 kg				

TOP LOCKING SHELVES

5	ART.		Dim. mm	
	M 53 PS46 00 10 00	--	969x631x46 H	
CAPACITY 150 kg				

BOTTOM LOCKING SHELVES

6	ART.		Dim. mm	
	M 53 PS46 10 10 00	--	969x724x46 H	
CAPACITY 150 kg				

ADJUSTABLE SHELF

7	ART.		Dim. mm	
	M 53 PR25 00 00 01	--	963x631x60 H	
CAN BE FITTED FRONTALLY TO THE VERTEBRATE BAR CAPACITY 100 kg				

ADJUSTABLE PERFORATED SHELF

8	ART.		Dim. mm	
	M 53 PR35 10 00 01	--	969x721x35 H	
MAY NOT BE INSERTED IN THE PRESENCE OF A VERTEBRATE BAR CAPACITY 250 kg				

VERTEBRATE BAR

9	ART.	bar H mm	
	M 00 V030 00 00 00 00	300	
	M 00 V050 00 00 00 00	500	
	M 00 V060 00 00 00 00	600	
	M 00 V070 00 00 00 00	700	
	M 00 V075 00 00 00 00	750	
	M 00 V090 00 00 00 00	900	
	M 00 V105 00 00 00 00	1050	
	M 00 V122 00 00 00 00	1225	
	M 00 V140 00 00 00 00	1400	
	M 00 V152 00 00 00 00	1525	
	M 00 V190 00 00 00 00	1900	

It is necessary to fit an anti-tilt rod if drawers or extension shelves are installed

CYLINDER CLOSURE (KEY)

10	ART.		
	M 53 V000 C0 00 00 00	C0	cylinder lock with different numbering
	M 53 V000 C1 00 00 00	C1	cylinder lock for sets of 160 numbers
	M 53 V000 C2 00 00 00	C2	cylinder lock for same numbering

COMPLETE WITH: 1 cylinder lock with 2 keys, 1 steel wire with sheath, 1 front pin assembly, 1 back pin assembly



KEY LOCK
Cylinder closure "C0" supplied as standard.
See Master section, page 31

LOCK WITH DIGITAL CODE (CODE)

11	ART.		
	M 53 V000 E2 00 00 00	E2	bar opening/closing
	M 53 V000 T2 00 00 00	T2	door+bar opening/closing

ART. REMOTE CONTROL

M 00 VRC0 00 00 00 00	Receiver module with remote control
M 00 VRC0 00 00 01 00	Additional remote control

REAR PANEL

12	ART.		Dim. mm	
	M 50 W100 P0 00 00	--	1019x1000 H	
	M 50 W150 P0 00 00	--	1019x1500 H	
	M 50 W200 P0 00 00	--	1019x2000 H	
	M 50 W225 P0 00 00	--	1019x2250 H	
	M 50 W250 P0 00 00	--	1019x2500 H	
	M 50 W300 P0 00 00	--	1019x3000 H	

A back panel must be fitted to each third bay

SIDE PANEL

13	ART.		Dim. mm	
	M 03 W100 L0 00 00	--	18x725x1000 H	
	M 03 W125 L0 00 00	--	18x725x1250 H	
	M 03 W150 L0 00 00	--	18x725x1500 H	

CROSS BRACINGS

14	ART.		For shelves height	
	M 50 X150 00 00 00	--	1500/2250	
	M 50 X250 00 00 00	--	2500/3000	

A cross bracing must be fitted to each third bay

SYSTEM SR-MASTER



15

FLEXIBLE EXTENSION DRAWERS

ART. WHIT Dark Grey plastic kit	ART. NO plastic kit*	Usable dim. mm	Front H mm	kg	
M 53 C050 0110 OF __	M 53 C050 0100 OF __	906x600x31 H	50	50 - 75 - 100	100% - 96% - 92%
M 53 C075 0110 OF __	M 53 C075 0100 OF __	906x600x56 H	75	50 - 75 - 100	100% - 96% - 92%
M 53 C100 0110 OF __	M 53 C100 0100 OF __	906x600x81 H	100	50 - 75 - 100	100% - 96% - 92%
M 53 C125 0110 OF __	M 53 C125 0100 OF __	906x600x106 H	125	50 - 75 - 100	100% - 96% - 92%
M 53 C150 0110 OF __	M 53 C150 0100 OF __	906x600x131 H	150	50 - 75 - 100	100% - 96% - 92%
M 53 C200 0110 OF __	M 53 C200 0100 OF __	906x600x181 H	200	50 - 75 - 100	100% - 96% - 92%
M 53 C250 0110 OF __	M 53 C250 0100 OF __	906x600x231 H	250	50 - 75 - 100	100% - 96% - 92%
M 53 C300 0110 OF __	M 53 C300 0100 OF __	906x600x281 H	300	50 - 75 - 100	100% - 96% - 92%

*MATCH THE ITEM NUMBER TO ONE OF THE PLASTIC KITS AVAILABLE IN THE TABLE BELOW



16

TELESCOPIC EXTRACTION DRAWERS

ART. WHIT Dark Grey plastic kit	ART. NO plastic kit*	Usable dim. mm	Front H mm	kg	
M 53 C075 0110 OT __	M 53 C075 0100 OT __	906x600x56 H	75	200	100%
M 53 C100 0110 OT __	M 53 C100 0100 OT __	906x600x81 H	100	200	100%
M 53 C125 0110 OT __	M 53 C125 0100 OT __	906x600x106 H	125	200	100%
M 53 C150 0110 OT __	M 53 C150 0100 OT __	906x600x131 H	150	200	100%
M 53 C200 0110 OT __	M 53 C200 0100 OT __	906x600x181 H	200	200	100%
M 53 C250 0110 OT __	M 53 C250 0100 OT __	906x600x231 H	250	200	100%
M 53 C300 0110 OT __	M 53 C300 0100 OT __	906x600x281 H	300	200	100%

*MATCH THE ITEM NUMBER TO ONE OF THE PLASTIC KITS AVAILABLE IN THE TABLE BELOW

PLASTIC KIT FOR DRAWERS AND RETRACTABLE SHELVES



PLASTIC COLOURS	ART.
MEDITERRANEAN BLUE	M 50 PLS1 00 00 00 M1
SKY BLUE	M 50 PLS1 00 00 00 M2
GLAMOUR RED	M 50 PLS1 00 00 00 M3
RED CARPET	M 50 PLS1 00 00 00 M4
JUICY ORANGE	M 50 PLS1 00 00 00 M5
SUNNY YELLOW	M 50 PLS1 00 00 00 M6
FOREST GREEN	M 50 PLS1 00 00 00 M7



17

FLEXIBLE EXTENSIBLE SHELVES

ART. WHIT Dark Grey plastic kit	ART. NO plastic kit*	Usable dim. mm	Front H mm	kg	
M 53 C057 0110 0F _ _	M 53 C057 0100 0F _ _	906x600	70	50 - 75 - 100	100% - 96% - 92%

*MATCH THE ITEM NUMBER TO ONE OF THE PLASTIC KITS AVAILABLE IN THE TABLE ON THE LEFT



18

TELESCOPIC EXTENSIBLE SHELVES

ART. WHIT Dark Grey plastic kit	ART. NO plastic kit*	Usable dim. mm	Front H mm	kg	
M 53 C057 0110 0T _ _	M 53 C057 0100 0T _ _	906x600	70	200	100%

*MATCH THE ITEM NUMBER TO ONE OF THE PLASTIC KITS AVAILABLE IN THE TABLE ON THE LEFT

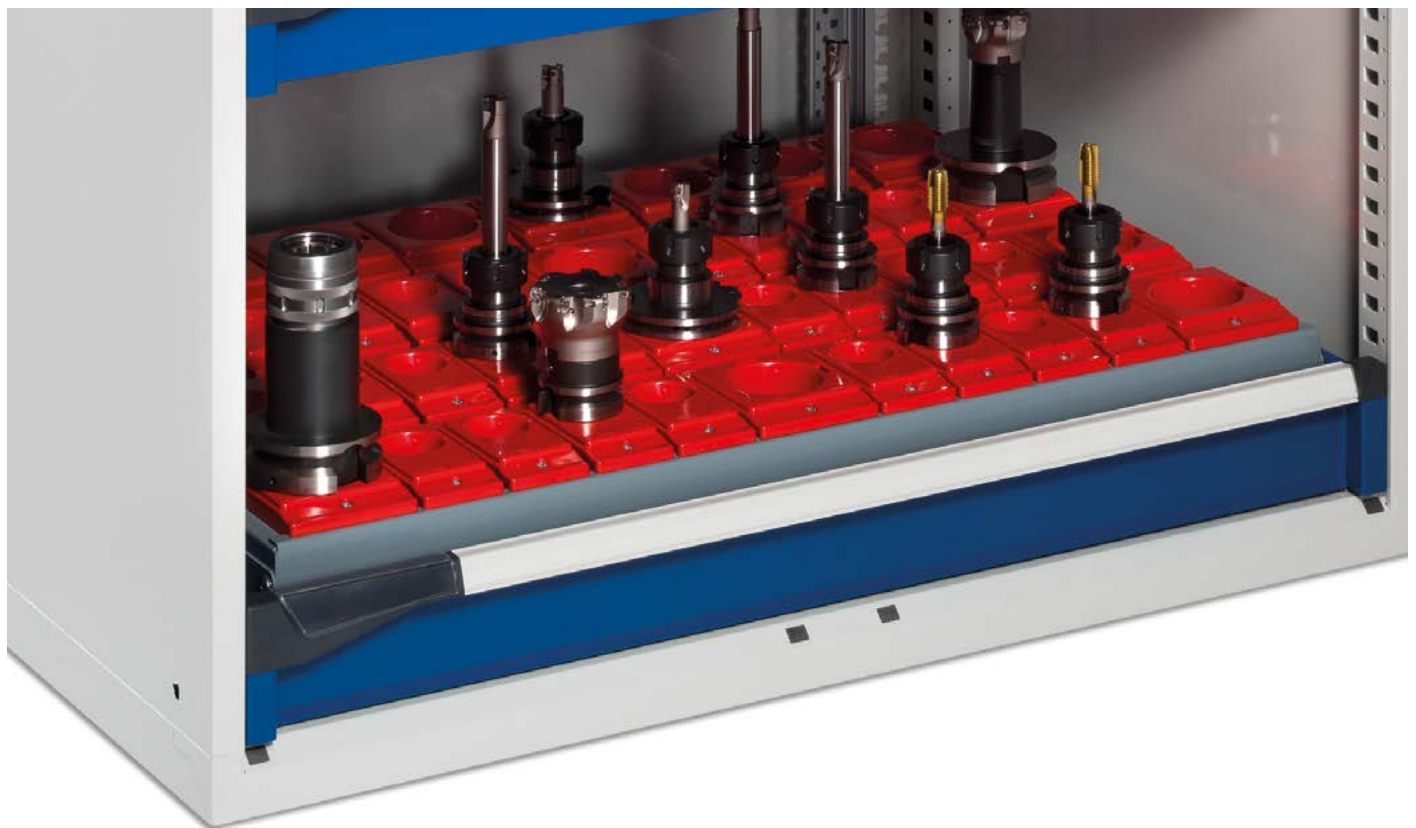

NC TOOL HOLDER ACCESSORIES
see page 614

SYSTEM SR-MASTER

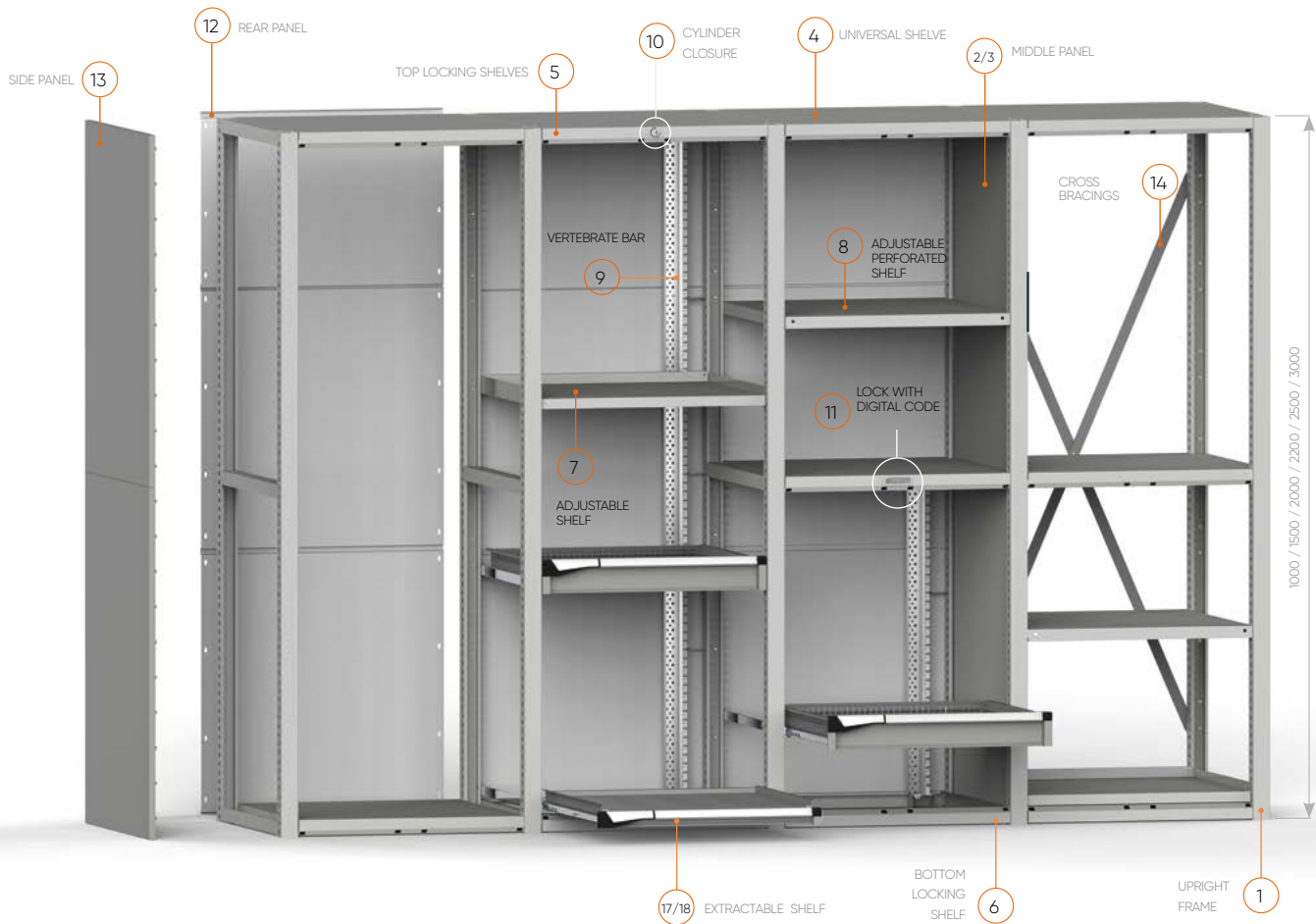

METAL COLOUR

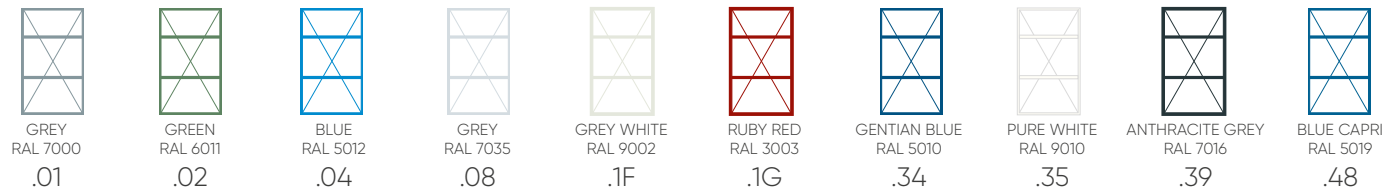

UPRIGHT FRAMES

1	ART.	Dim. mm
	M 03 F100 00 00 01	51x726x1000 H
	M 03 F150 00 00 01	51x726x1500 h
	M 03 F200 00 00 01	51x726x2000 H
	M 03 F225 00 00 01	51x726x2250 H
	M 03 F250 00 00 01	51x726x2500 H
	M 03 F300 00 00 01	51x726x3000 H

COMPLETE WITH CLOSING CAPS

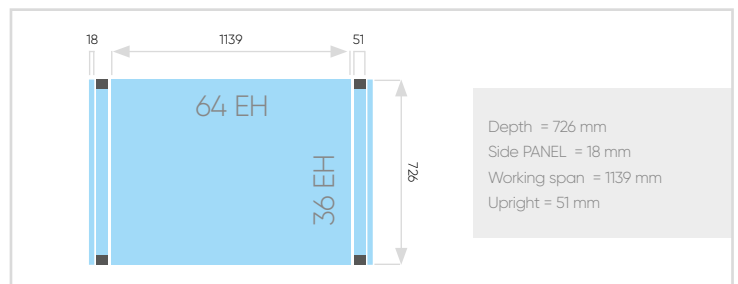

2 BOTTOM WALL

H side	ART.	Dim. mm H
1000	-	1000
1500	-	1500
2000	M 03 W100 MO 20 00	1000
2250	M 03 W100 MO 20 00	1000
2500	M 03 W100 MO 20 00	1000
3000	M 03 W100 MO 20 00	1000

3 TOP WALL

ART.	Dim. mm H
-	-
M 03 W100 MO 10 00	1000
M 03 W125 MO 10 00	1250
M 03 W150 MO 10 00	1500
M 03 W100 MO 10 00*	1000

*For the 3000 mm height, two top middle walls are required to seal the side

MIDDLE PANELS

UNIVERSAL SHELF

4	ART.		Dim. mm
	M 63 PT46 00 10 00 _ _		1139x724x46 H

CAPACITY 250 kg

TOP LOCKING SHELVES

5	ART.		Dim. mm
	M 63 PS46 00 10 00 _ _		1139x724x46 H

CAPACITY 150 kg

BOTTOM LOCKING SHELVES

6	ART.		Dim. mm
	M 63 PS46 10 10 00 _ _		1139x724x46 H

CAPACITY 150 kg

ADJUSTABLE SHELF

7	ART.		Dim. mm
	M 63 PR25 00 00 01 _ _		1133x631x60 H

CAN BE FITTED FRONTALLY TO THE VERTEBRATE BAR
CAPACITY 150 kg

ADJUSTABLE PERFORATED SHELF

8	ART.		Dim. mm
	M 63 PR35 10 00 01 _ _		1139x721x35 H

MAY NOT BE INSERTED IN THE PRESENCE OF A VERTEBRATE BAR
CAPACITY 300 kg

VERTEBRATE BAR

9	ART.	bar H mm
	M 00 V030 00 00 00 00	300
	M 00 V050 00 00 00 00	500
	M 00 V060 00 00 00 00	600
	M 00 V070 00 00 00 00	700
	M 00 V075 00 00 00 00	750
	M 00 V090 00 00 00 00	900
	M 00 V105 00 00 00 00	1050
	M 00 V122 00 00 00 00	1225
	M 00 V140 00 00 00 00	1400
	M 00 V152 00 00 00 00	1525
	M 00 V190 00 00 00 00	1900

It is necessary to fit an anti-tilt rod if drawers or extension shelves are installed

CYLINDER CLOSURE (KEY)

10	ART.	
	M 63 V000 C0 00 00 00	C0 cylinder lock with different numbering
	M 63 V000 C1 00 00 00	C1 cylinder lock for sets of 160 numbers
	M 63 V000 C2 00 00 00	C2 cylinder lock for same numbering

COMPLETE WITH: 1 cylinder lock with 2 keys, 1 steel wire with sheath, 1 front pin assembly, 1 back pin assembly



KEY LOCK
Cylinder closure "C0" supplied as standard.
See Master section, page 31



LOCK WITH DIGITAL CODE (CODE)

11	ART.	
	M 63 V000 E2 00 00 00	E2 bar opening/closing
	M 63 V000 T2 00 00 00	T2 door+bar opening/closing

ART. REMOTE CONTROL

M 00 VRC0 00 00 00 00	Receiver module with remote control
M 00 VRC0 00 00 01 00	Additional remote control

REAR PANEL

12	ART.		Dim. mm
	M 60 W100 P0 00 00 _ _		1189x1000 H
	M 60 W150 P0 00 00 _ _		1189x1500 H
	M 60 W200 P0 00 00 _ _		1189x2000 H
	M 60 W225 P0 00 00 _ _		1189x2250 H
	M 60 W250 P0 00 00 _ _		1189x2500 H
	M 60 W300 P0 00 00 _ _		1189x3000 H

A back panel must be fitted to each third bay

SIDE PANEL

13	ART.		Dim. mm
	M 03 W100 L0 00 00 _ _		18x725x1000 H
	M 03 W125 L0 00 00 _ _		18x725x1250 H
	M 03 W150 L0 00 00 _ _		18x725x1500 H

CROSS BRACINGS

14	ART.		For shelves height
	M 60 X150 00 00 00 _ _		1500/2250
	M 60 X250 00 00 00 _ _		2500/3000

A cross bracing must be fitted to each third bay

SYSTEM SR-MASTER



15

FLEXIBLE EXTENSION DRAWERS

ART. WHIT Dark Grey plastic kit	ART. NO plastic kit*	Usable dim. mm	Front H mm	kg	
M 63 C075 0110 OF __	M 63 C075 0100 OF __	1076x600x56 H	75	50 - 75 - 100	100% - 96% - 92%
M 63 C100 0110 OF __	M 63 C100 0100 OF __	1076x600x81 H	100	50 - 75 - 100	100% - 96% - 92%
M 63 C125 0110 OF __	M 63 C125 0100 OF __	1076x600x106 H	125	50 - 75 - 100	100% - 96% - 92%
M 63 C150 0110 OF __	M 63 C150 0100 OF __	1076x600x131 H	150	50 - 75 - 100	100% - 96% - 92%
M 63 C200 0110 OF __	M 63 C200 0100 OF __	1076x600x181 H	200	50 - 75 - 100	100% - 96% - 92%
M 63 C250 0110 OF __	M 63 C250 0100 OF __	1076x600x231 H	250	50 - 75 - 100	100% - 96% - 92%
M 63 C300 0110 OF __	M 63 C300 0100 OF __	1076x600x281 H	300	50 - 75 - 100	100% - 96% - 92%

*MATCH THE ITEM NUMBER TO ONE OF THE PLASTIC KITS AVAILABLE IN THE TABLE BELOW



16

TELESCOPIC EXTRACTION DRAWERS

ART. WHIT Dark Grey plastic kity	ART. NO plastic kit*	Usable dim. mm	Front H mm	kg	
M 63 C075 0110 OT __	M 63 C075 0100 OT __	1076x600x56 H	75	200	100%
M 63 C100 0110 OT __	M 63 C100 0100 OT __	1076x600x81 H	100	200	100%
M 63 C125 0110 OT __	M 63 C125 0100 OT __	1076x600x106 H	125	200	100%
M 63 C150 0110 OT __	M 63 C150 0100 OT __	1076x600x131 H	150	200	100%
M 63 C200 0110 OT __	M 63 C200 0100 OT __	1076x600x181 H	200	200	100%
M 63 C250 0110 OT __	M 63 C250 0100 OT __	1076x600x231 H	250	200	100%
M 63 C300 0110 OT __	M 63 C300 0100 OT __	1076x600x281 H	300	200	100%

*MATCH THE ITEM NUMBER TO ONE OF THE PLASTIC KITS AVAILABLE IN THE TABLE BELOW

PLASTIC KIT FOR DRAWERS AND RETRACTABLE SHELVES



PLASTIC COLOURS	ART.
MEDITERRANEAN BLUE	M 60 PLS1 00 00 00 M1
SKY BLUE	M 60 PLS1 00 00 00 M2
GLAMOUR RED	M 60 PLS1 00 00 00 M3
RED CARPET	M 60 PLS1 00 00 00 M4
JUICY ORANGE	M 60 PLS1 00 00 00 M5
SUNNY YELLOW	M 60 PLS1 00 00 00 M6
FOREST GREEN	M 60 PLS1 00 00 00 M7



17

FLEXIBLE EXTENSIBLE SHELVES

ART. WHIT Dark Grey plastic kit	ART. NO plastic kit*	Usable dim. mm	Front H mm	kg	
M 63 C057 0110 0F _ _	M 63 C057 0100 0F _ _	1076x600	70	50 - 75 - 100	100% - 96% - 92%

*MATCH THE ITEM NUMBER TO ONE OF THE PLASTIC KITS AVAILABLE IN THE TABLE ON THE LEFT



18

TELESCOPIC EXTENSIBLE SHELVES

ART. WHIT Dark Grey plastic kit	ART. NO plastic kit*	Usable dim. mm	Front H mm	kg	
M 63 C057 0110 0T _ _	M 63 C057 0100 0T _ _	1076x600	70	200	100%

*MATCH THE ITEM NUMBER TO ONE OF THE PLASTIC KITS AVAILABLE IN THE TABLE ON THE LEFT



SYSTEM SR-MASTER

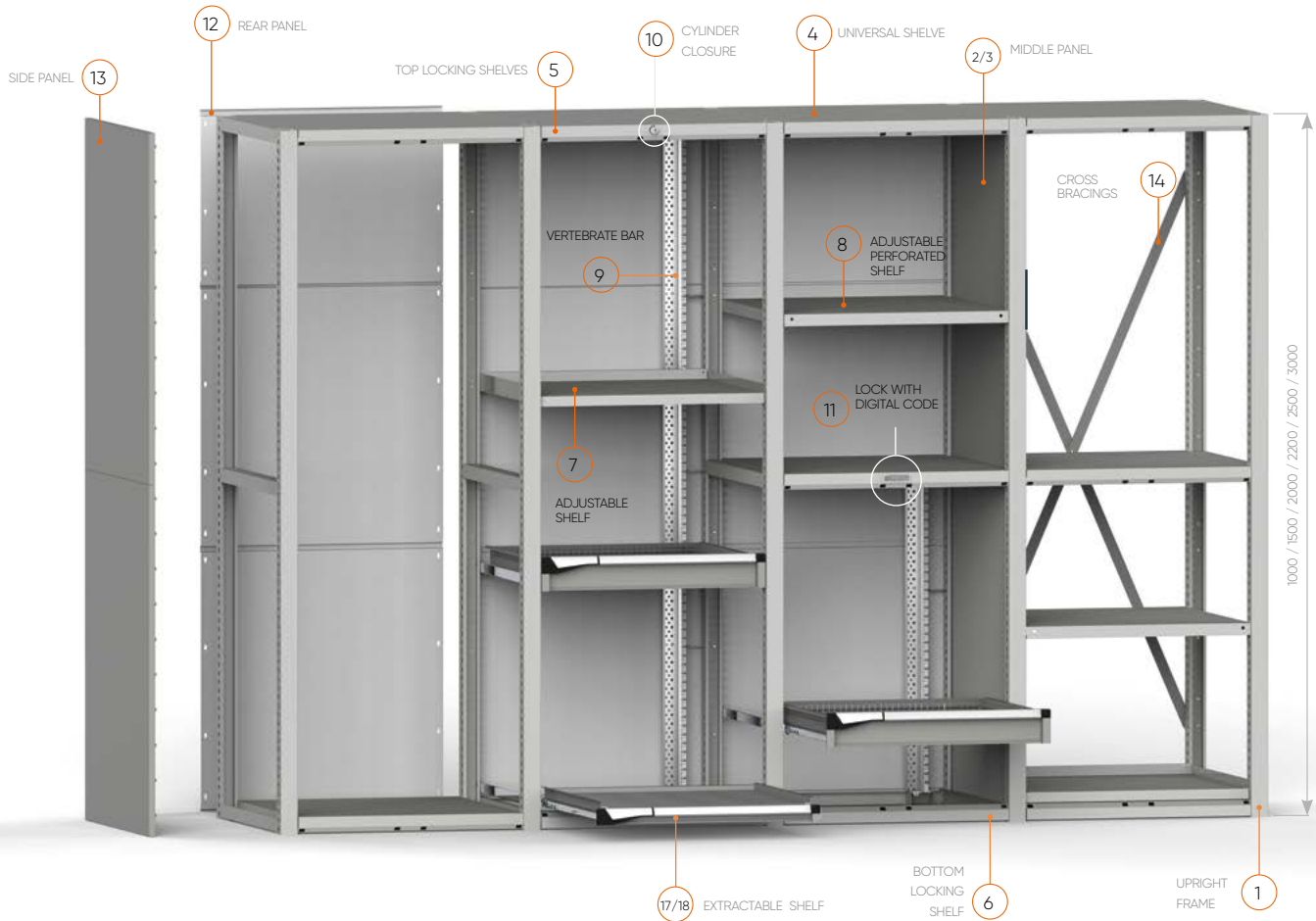

METAL COLOUR



UPRIGHT FRAMES

1	ART.	Dim. mm
	M 03 F100 00 00 01	51x726x1000 H
	M 03 F150 00 00 01	51x726x1500 H
	M 03 F200 00 00 01	51x726x2000 H
	M 03 F225 00 00 01	51x726x2250 H
	M 03 F250 00 00 01	51x726x2500 H
	M 03 F300 00 00 01	51x726x3000 H

COMPLETE WITH CLOSING CAPS

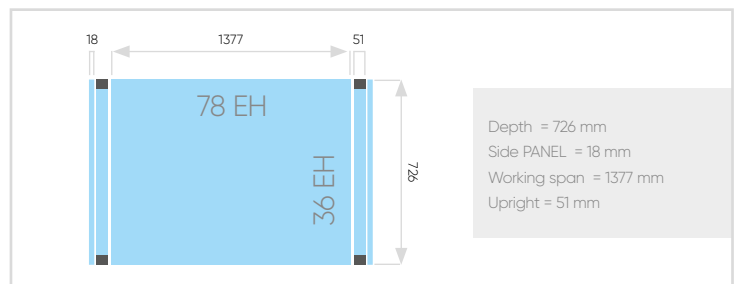

2 BOTTOM WALL

H side	ART.	Dim. mm H
1000	-	-
1500	-	-
2000	M 03 W100 MO 20 00	1000
2250	M 03 W100 MO 20 00	1000
2500	M 03 W100 MO 20 00	1000
3000	M 03 W100 MO 20 00	1000

3 TOP WALL

ART.	Dim. mm H
-	-
-	-
M 03 W100 MO 10 00	1000
M 03 W125 MO 10 00	1250
M 03 W150 MO 10 00	1500
M 03 W100 MO 10 00*	1000

*For the 3000 mm height, two top middle walls are required to seal the side

MIDDLE PANELS

UNIVERSAL SHELF

4	ART.		Dim. mm
	M 73 PT46 00 10 00 _ _		1377x724x46 H

CAPACITY 250 kg

TOP LOCKING SHELVES

5	ART.		Dim. mm
	M 73 PS46 00 10 00 _ _		1377x724x46 H

CAPACITY 150 kg

BOTTOM LOCKING SHELVES

6	ART.		Dim. mm
	M 73 PS46 10 10 00 _ _		1377x724x46 H

CAPACITY 150 kg

ADJUSTABLE PERFORATED SHELF

7	ART.		Dim. mm
	M 73 PR25 00 00 01 _ _		1371x631x60 H

CAN BE FITTED FRONTALLY TO THE VERTEBRATE BAR
CAPACITY 150 kg

ADJUSTABLE PERFORATED SHELF

8	ART.		Dim. mm
	M 73 PR35 10 00 01 _ _		1377x721x35 H

MAY NOT BE INSERTED IN THE PRESENCE OF A VERTEBRATE BAR
CAPACITY 300 kg

VERTEBRATE BAR

9	ART.	bar H mm
	M 00 V030 00 00 00 00	300
	M 00 V050 00 00 00 00	500
	M 00 V060 00 00 00 00	600
	M 00 V070 00 00 00 00	700
	M 00 V075 00 00 00 00	750
	M 00 V090 00 00 00 00	900
	M 00 V105 00 00 00 00	1050
	M 00 V122 00 00 00 00	1225
	M 00 V140 00 00 00 00	1400
	M 00 V152 00 00 00 00	1525
	M 00 V190 00 00 00 00	1900

It is necessary to fit an anti-tilt rod if drawers or extension shelves are installed

CYLINDER CLOSURE (KEY)

10	ART.	
	M 73 V000 C0 00 00 00	C0 cylinder lock with different numbering
	M 73 V000 C1 00 00 00	C1 cylinder lock for sets of 160 numbers
	M 73 V000 C2 00 00 00	C2 cylinder lock for same numbering

COMPLETE WITH: 1 cylinder lock with 2 keys, 1 steel wire with sheath, 1 front pin assembly, 1 back pin assembly



KEY LOCK
Cylinder closure "C0" supplied as standard.
See Master section, page 31



LOCK WITH DIGITAL CODE (CODE)

11	ART.	
	M 73 V000 E2 00 00 00	E2 bar opening/closing
	M 73 V000 T2 00 00 00	T2 door+bar opening/closing

ART. REMOTE CONTROL

M 00 VRC0 00 00 00 00	Receiver module with remote control
M 00 VRC0 00 00 01 00	Additional remote control

REAR PANEL

12	ART.		Dim. mm
	M 70 W100 PO 00 00 _ _		1427x1000 H
	M 70 W150 PO 00 00 _ _		1427x1500 H
	M 70 W200 PO 00 00 _ _		1427x2000 H
	M 70 W225 PO 00 00 _ _		1427x2250 H
	M 70 W250 PO 00 00 _ _		1427x2500 H
	M 70 W300 PO 00 00 _ _		1427x3000 H

A back panel must be fitted to each third bay

SIDE PANEL

13	ART.		Dim. mm
	M 03 W100 LO 00 00 _ _		18x725x1000 H
	M 03 W125 LO 00 00 _ _		18x725x1250 H
	M 03 W150 LO 00 00 _ _		18x725x1500 H

CROSS BRACINGS

14	ART.		For shelves height
	M 70 X150 00 00 00 _ _		1500/2250
	M 70 X250 00 00 00 _ _		2500/3000

A cross bracing must be fitted to each third bay

SYSTEM SR-MASTER



FLEXIBLE EXTENSION DRAWERS

ART. WHIT Dark Grey plastic kity	ART. NO plastic kit*	Usable dim. mm	Front H mm	kg	
M 73 C075 0110 OF __	M 73 C075 0100 OF __	1314x600x56 H	75	50 - 75 - 100	100% - 96% - 92%
M 73 C100 0110 OF __	M 73 C100 0100 OF __	1314x600x81 H	100	50 - 75 - 100	100% - 96% - 92%
M 73 C125 0110 OF __	M 73 C125 0100 OF __	1314x600x106 H	125	50 - 75 - 100	100% - 96% - 92%
M 73 C150 0110 OF __	M 73 C150 0100 OF __	1314x600x131 H	150	50 - 75 - 100	100% - 96% - 92%
M 73 C200 0110 OF __	M 73 C200 0100 OF __	1314x600x181 H	200	50 - 75 - 100	100% - 96% - 92%
M 73 C250 0110 OF __	M 73 C250 0100 OF __	1314x600x231 H	250	50 - 75 - 100	100% - 96% - 92%
M 73 C300 0110 OF __	M 73 C300 0100 OF __	1314x600x281 H	300	50 - 75 - 100	100% - 96% - 92%

*MATCH THE ITEM NUMBER TO ONE OF THE PLASTIC KITS AVAILABLE IN THE TABLE BELOW



TELESCOPIC EXTRACTION DRAWERS

ART. WHIT Dark Grey plastic kity	ART. NO plastic kit*	Usable dim. mm	Front H mm	kg	
M 73 C075 0110 OT __	M 73 C075 0100 OT __	1314x600x56 H	75	200	100%
M 73 C100 0110 OT __	M 73 C100 0100 OT __	1314x600x81 H	100	200	100%
M 73 C125 0110 OT __	M 73 C125 0100 OT __	1314x600x106 H	125	200	100%
M 73 C150 0110 OT __	M 73 C150 0100 OT __	1314x600x131 H	150	200	100%
M 73 C200 0110 OT __	M 73 C200 0100 OT __	1314x600x181 H	200	200	100%
M 73 C250 0110 OT __	M 73 C250 0100 OT __	1314x600x231 H	250	200	100%
M 73 C300 0110 OT __	M 73 C300 0100 OT __	1314x600x281 H	300	200	100%

*MATCH THE ITEM NUMBER TO ONE OF THE PLASTIC KITS AVAILABLE IN THE TABLE BELOW

PLASTIC KIT FOR DRAWERS AND RETRACTABLE SHELVES



PLASTIC COLOURS	ART.
MEDITERRANEAN BLUE	M 70 PLS1 00 00 00 M1
SKY BLUE	M 70 PLS1 00 00 00 M2
GLAMOUR RED	M 70 PLS1 00 00 00 M3
RED CARPET	M 70 PLS1 00 00 00 M4
JUICY ORANGE	M 70 PLS1 00 00 00 M5
SUNNY YELLOW	M 70 PLS1 00 00 00 M6
FOREST GREEN	M 70 PLS1 00 00 00 M7



FLEXIBLE EXTENSIBLE SHELVES

ART. WHIT Dark Grey plastic kity	ART. NO plastic kit*	Usable dim. mm	Front H mm	kg	
M73 C057 0110 0F __	M73 C057 0100 0F __	1314x600	70	50 - 75 - 100	100% - 96% - 92%

*MATCH THE ITEM NUMBER TO ONE OF THE PLASTIC KITS AVAILABLE IN THE TABLE ON THE LEFT



TELESCOPIC EXTENSIBLE SHELVES

ART. WHIT Dark Grey plastic kity	ART. NO plastic kit*	Usable dim. mm	Front H mm	kg	
M73 C057 0110 0T __	M73 C057 0100 0T __	1314x600	70	200	100%

*MATCH THE ITEM NUMBER TO ONE OF THE PLASTIC KITS AVAILABLE IN THE TABLE ON THE LEFT



SYSTEM SR-MASTER



PLASTIC KIT







COLOURS

8 colours for plastic accessories









PLASTIC KIT CYLINDER LOCK



PLASTIC COLOUR	ART. for single door	ART. for double doors
 MEDITERRANEAN BLUE	M 00 PLS0 00 00 20 M1	M 00 PLS0 00 00 30 M1
 SKY BLUE	M 00 PLS0 00 00 20 M2	M 00 PLS0 00 00 30 M2
 GLAMOUR RED	M 00 PLS0 00 00 20 M3	M 00 PLS0 00 00 30 M3
 RED CARPET	M 00 PLS0 00 00 20 M4	M 00 PLS0 00 00 30 M4
 JUICY ORANGE	M 00 PLS0 00 00 20 M5	M 00 PLS0 00 00 30 M5
 SUNNY YELLOW	M 00 PLS0 00 00 20 M6	M 00 PLS0 00 00 30 M6
 FOREST GREEN	M 00 PLS0 00 00 20 M7	M 00 PLS0 00 00 30 M7







PLASTIC KIT NUMERICAL CODE



PLASTIC COLOUR	ART. for single door	ART. for double doors
 MEDITERRANEAN BLUE	M 00 PLS0 00 00 21 M1	M 00 PLS0 00 00 31 M1
 SKY BLUE	M 00 PLS0 00 00 21 M2	M 00 PLS0 00 00 31 M2
 GLAMOUR RED	M 00 PLS0 00 00 21 M3	M 00 PLS0 00 00 31 M3
 RED CARPET	M 00 PLS0 00 00 21 M4	M 00 PLS0 00 00 31 M4
 JUICY ORANGE	M 00 PLS0 00 00 21 M5	M 00 PLS0 00 00 31 M5
 SUNNY YELLOW	M 00 PLS0 00 00 21 M6	M 00 PLS0 00 00 31 M6
 FOREST GREEN	M 00 PLS0 00 00 21 M7	M 00 PLS0 00 00 31 M7

PLASTIC KIT FOR SLIDING DOORS









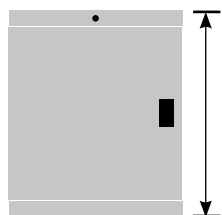

PLASTIC COLOUR	ART. 2 sliding doors	ART. 1 sliding door
 MEDITERRANEAN BLUE	M 00 PLS0 00 00 50 M1	M 00 PLS0 00 00 40 M1
 SKY BLUE	M 00 PLS0 00 00 50 M2	M 00 PLS0 00 00 40 M2
 GLAMOUR RED	M 00 PLS0 00 00 50 M3	M 00 PLS0 00 00 40 M3
 RED CARPET	M 00 PLS0 00 00 50 M4	M 00 PLS0 00 00 40 M4
 JUICY ORANGE	M 00 PLS0 00 00 50 M5	M 00 PLS0 00 00 40 M5
 SUNNY YELLOW	M 00 PLS0 00 00 50 M6	M 00 PLS0 00 00 40 M6
 FOREST GREEN	M 00 PLS0 00 00 50 M7	M 00 PLS0 00 00 40 M7

SYSTEM SR-MASTER

🔑 HINGED DOORS WITH CYLINDER

FULL HEIGHT HINGED DOORS - REVERSIBLE









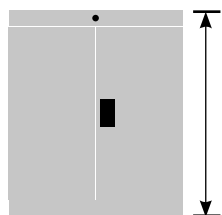







DOOR FOOTPRINT H mm**	TYPE OF CLOSURE	ART. WITH Dark Grey plastic kit 	ART. NO Plastic kit* 
600	 C0 KEY cylinder lock	M30P050C01000 __	M30P050C00000 __
	 C1 KEY cylinder lock	M30P050C11000 __	M30P050C10000 __
	 C2 KEY cylinder lock	M30P050C21000 __	M30P050C20000 __
700	 C0 KEY cylinder lock	M30P060C01000 __	M30P060C00000 __
	 C1 KEY cylinder lock	M30P060C11000 __	M30P060C10000 __
	 C2 KEY cylinder lock	M30P060C21000 __	M30P060C20000 __

**HEIGHT INCLUDING TOP AND BOTTOM STRENGTHENING SHELVES

FULL HEIGHT HINGED DOOR PAIR



DOOR FOOTPRINT H mm**	TYPE OF CLOSURE	ART. WITH Dark Grey plastic kit 	ART. NO Plastic kit* 
850	 C0 KEY cylinder lock	M30P075C01010 __	M30P075C00010 __
	 C1 KEY cylinder lock	M30P075C11010 __	M30P075C10010 __
	 C2 KEY cylinder lock	M30P075C21010 __	M30P075C20010 __
1000	 C0 KEY cylinder lock	M30P090C01010 __	M30P090C00010 __
	 C1 KEY cylinder lock	M30P090C11010 __	M30P090C10010 __
	 C2 KEY cylinder lock	M30P090C21010 __	M30P090C20010 __
1500	 C0 KEY cylinder lock	M30P140C01010 __	M30P140C00010 __
	 C1 KEY cylinder lock	M30P140C11010 __	M30P140C10010 __
	 C2 KEY cylinder lock	M30P140C21010 __	M30P140C20010 __
2000	 C0 KEY cylinder lock	M30P190C01010 __	M30P190C00010 __
	 C1 KEY cylinder lock	M30P190C11010 __	M30P190C10010 __
	 C2 KEY cylinder lock	M30P190C21010 __	M30P190C20010 __

**HEIGHT INCLUDING TOP AND BOTTOM STRENGTHENING SHELVES



HINGED DOORS WITH NUMERICAL CODE

FULL HEIGHT HINGED DOORS - RIGHT-HAND OPENING ONLY

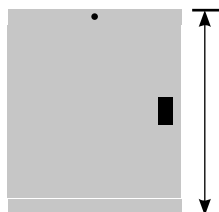

CABINET H mm**	TYPE OF CLOSURE	ART. WITH Dark Grey plastic kit	ART. NO Plastic kit*
600	P5 CODE numerical code	M 30 P050 P5 10 00 __	M 30 P050 P5 00 00 __
700	P5 CODE numerical code	M 30 P060 P5 10 00 __	M 30 P050 P5 00 00 __

**HEIGHT INCLUDING TOP AND BOTTOM STRENGTHENING SHELVES

FULL HEIGHT HINGED DOOR PAIR

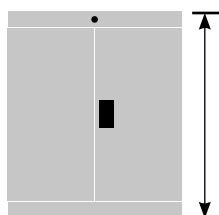

CABINET H mm**	TYPE OF CLOSURE	ART. WITH Dark Grey plastic kit	ART. NO Plastic kit*
850	P5 CODE numerical code	M 30 P075 P5 10 10 __	M 30 P075 P5 00 10 __
1000	P5 CODE numerical code	M 30 P090 P5 10 10 __	M 30 P090 P5 00 10 __
1500	P5 CODE numerical code	M 30 P140 P5 10 10 __	M 30 P140 P5 00 10 __
2000	P5 CODE numerical code	M 30 P190 P5 10 10 __	M 30 P190 P5 00 10 __

**HEIGHT INCLUDING TOP AND BOTTOM STRENGTHENING SHELVES



LOCKS SEE PAGE 31



*PLASTIC COLOURS SEE PAGE 1368



HINGED DOORS WITH CYLINDER

FULL HEIGHT HINGED DOOR PAIR

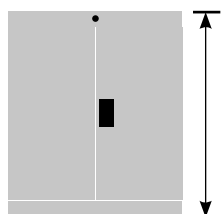

DOOR FOOTPRINT H mm**	TYPE OF CLOSURE	ART. WITH Dark Grey plastic kit	ART. NO Plastic kit*
850	C0 KEY cylinder lock	M 40 P075 C010 10 __	M 40 P075 C0 00 10 __
	C1 KEY cylinder lock	M 40 P075 C110 10 __	M 40 P075 C1 00 10 __
	C2 KEY cylinder lock	M 40 P075 C210 10 __	M 40 P075 C2 00 10 __
1000	C0 KEY cylinder lock	M 40 P090 C010 10 __	M 40 P090 C0 00 10 __
	C1 KEY cylinder lock	M 40 P090 C110 10 __	M 40 P090 C1 00 10 __
	C2 KEY cylinder lock	M 40 P090 C210 10 __	M 40 P090 C2 00 10 __
1500	C0 KEY cylinder lock	M 40 P140 C010 10 __	M 40 P140 C0 00 10 __
	C1 KEY cylinder lock	M 40 P140 C110 10 __	M 40 P140 C1 00 10 __
	C2 KEY cylinder lock	M 40 P140 C210 10 __	M 40 P140 C2 00 10 __
2000	C0 KEY cylinder lock	M 40 P190 C010 10 __	M 40 P190 C0 00 10 __
	C1 KEY cylinder lock	M 40 P190 C110 10 __	M 40 P190 C1 00 10 __
	C2 KEY cylinder lock	M 40 P190 C210 10 __	M 40 P190 C2 00 10 __

**HEIGHT INCLUDING TOP AND BOTTOM STRENGTHENING SHELVES



HINGED DOORS WITH NUMERICAL CODE

FULL HEIGHT HINGED DOOR PAIR

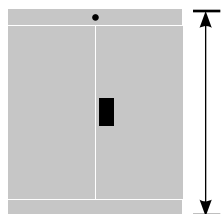

DOOR FOOTPRINT H mm**	TYPE OF CLOSURE	ART. WITH Dark Grey plastic kit	ART. NO Plastic kit*
850	P5 CODE numerical code	M 40 P075 P510 10 __	M 40 P075 P5 00 10 __
1000	P5 CODE numerical code	M 40 P090 P510 10 __	M 40 P090 P5 00 10 __
1500	P5 CODE numerical code	M 40 P140 P510 10 __	M 40 P140 P5 00 10 __
2000	P5 CODE numerical code	M 40 P190 P510 10 __	M 40 P190 P5 00 10 __

**HEIGHT INCLUDING TOP AND BOTTOM STRENGTHENING SHELVES

HINGED DOORS WITH CYLINDER

FULL HEIGHT HINGED DOOR PAIR

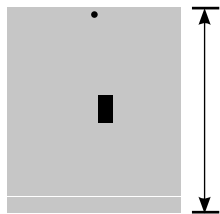

DOOR FOOTPRINT H mm**	TYPE OF CLOSURE	ART. WITH Dark Grey plastic kit	ART. NO Plastic kit*
850	C0 KEY cylinder lock	M 50 P075 C01010 __	M 50 P075 C00010 __
	C1 KEY cylinder lock	M 50 P075 C11010 __	M 50 P075 C10010 __
	C2 KEY cylinder lock	M 50 P075 C21010 __	M 50 P075 C20010 __
1000	C0 KEY cylinder lock	M 50 P090 C01010 __	M 50 P090 C00010 __
	C1 KEY cylinder lock	M 50 P090 C11010 __	M 50 P090 C10010 __
	C2 KEY cylinder lock	M 50 P090 C21010 __	M 50 P090 C20010 __
1500	C0 KEY cylinder lock	M 50 P140 C01010 __	M 50 P140 C00010 __
	C1 KEY cylinder lock	M 50 P140 C11010 __	M 50 P140 C10010 __
	C2 KEY cylinder lock	M 50 P140 C21010 __	M 50 P140 C20010 __
2000	C0 KEY cylinder lock	M 50 P190 C01010 __	M 50 P190 C00010 __
	C1 KEY cylinder lock	M 50 P190 C11010 __	M 50 P190 C10010 __
	C2 KEY cylinder lock	M 50 P190 C21010 __	M 50 P190 C20010 __

**HEIGHT INCLUDING TOP AND BOTTOM STRENGTHENING SHELVES



HINGED DOORS WITH NUMERICAL CODE

FULL HEIGHT HINGED DOOR PAIR

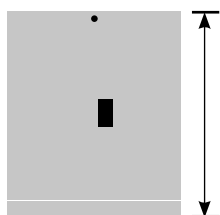

DOOR FOOTPRINT H mm**	TYPE OF CLOSURE	ART. WITH Dark Grey plastic kit	ART. NO Plastic kit*
850	P5 CODE numerical code	M 50 P075 P51010 __	M 50 P075 P50010 __
1000	P5 CODE numerical code	M 50 P090 P51010 __	M 50 P090 P50010 __
1500	P5 CODE numerical code	M 50 P140 P51010 __	M 50 P140 P50010 __
2000	P5 CODE numerical code	M 50 P190 P51010 __	M 50 P190 P50010 __

**HEIGHT INCLUDING TOP AND BOTTOM STRENGTHENING SHELVES



LOCKS SEE PAGE 31









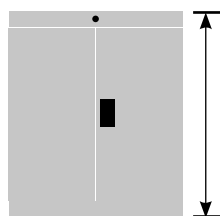







*PLASTIC COLOURS SEE PAGE 1368

HINGED DOORS WITH CYLINDER

FULL HEIGHT HINGED DOOR PAIR







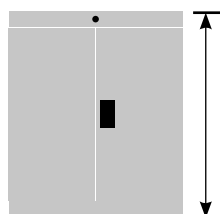

DOOR FOOTPRINT H mm**	TYPE OF CLOSURE	ART. WITH Dark Grey plastic kit 	ART. NO Plastic kit* 
850	 C0 KEY cylinder lock	M 60 P075 C01010 __	M60P075C00010 __
	 C1 KEY cylinder lock	M 60 P075 C11010 __	M60P075C10010 __
	 C2 KEY cylinder lock	M 60 P075 C21010 __	M60P075C20010 __
1000	 C0 KEY cylinder lock	M 60 P090 C01010 __	M60P090C00010 __
	 C1 KEY cylinder lock	M 60 P090 C11010 __	M60P090C10010 __
	 C2 KEY cylinder lock	M 60 P090 C21010 __	M60P090C20010 __
1500	 C0 KEY cylinder lock	M 60 P140 C01010 __	M60P140C00010 __
	 C1 KEY cylinder lock	M 60 P140 C11010 __	M60P140C10010 __
	 C2 KEY cylinder lock	M 60 P140 C21010 __	M60P140C20010 __
2000	 C0 KEY cylinder lock	M 60 P190 C01010 __	M60P190C00010 __
	 C1 KEY cylinder lock	M 60 P190 C11010 __	M60P190C10010 __
	 C2 KEY cylinder lock	M 60 P190 C21010 __	M60P190C20010 __

**HEIGHT INCLUDING TOP AND BOTTOM STRENGTHENING SHELVES

HINGED DOORS WITH NUMERICAL CODE

FULL HEIGHT HINGED DOOR PAIR



DOOR FOOTPRINT H mm**	TYPE OF CLOSURE	ART. WITH Dark Grey plastic kit 	ART. NO Plastic kit* 
850	 P5 CODE numerical code	M 60 P075 P51010 __	M60P075P50010 __
1000	 P5 CODE numerical code	M 60 P090 P51010 __	M60P090P50010 __
1500	 P5 CODE numerical code	M 60 P140 P51010 __	M60P140P50010 __
2000	 P5 CODE numerical code	M 60 P190 P51010 __	M60P190P50010 __

**HEIGHT INCLUDING TOP AND BOTTOM STRENGTHENING SHELVES

HINGED DOORS WITH CYLINDER

FULL HEIGHT HINGED DOOR PAIR

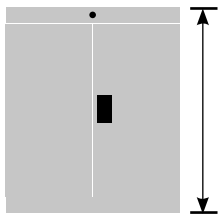

DOOR FOOTPRINT H mm**	TYPE OF CLOSURE	ART. WITH Dark Grey plastic kit	ART. NO Plastic kit*
850	C0 KEY cylinder lock	M 70 P075 C0 10 10 __	M 70 P075 C00010 __
	C1 KEY cylinder lock	M 70 P075 C110 10 __	M 70 P075 C100 10 __
	C2 KEY cylinder lock	M 70 P075 C210 10 __	M 70 P075 C20010 __
1000	C0 KEY cylinder lock	M 70 P090 C0 10 10 __	M 70 P090 C00010 __
	C1 KEY cylinder lock	M 70 P090 C110 10 __	M 70 P090 C10010 __
	C2 KEY cylinder lock	M 70 P090 C210 10 __	M 70 P090 C20010 __
1500	C0 KEY cylinder lock	M 70 P140 C0 10 10 __	M 70 P140 C00010 __
	C1 KEY cylinder lock	M 70 P140 C110 10 __	M 70 P140 C100 10 __
	C2 KEY cylinder lock	M 70 P140 C210 10 __	M 70 P140 C20010 __
2000	C0 KEY cylinder lock	M 70 P190 C0 10 10 __	M 70 P190 C00010 __
	C1 KEY cylinder lock	M 70 P190 C110 10 __	M 70 P190 C100 10 __
	C2 KEY cylinder lock	M 70 P190 C210 10 __	M 70 P190 C200 10 __

**HEIGHT INCLUDING TOP AND BOTTOM STRENGTHENING SHELVES



HINGED DOORS WITH NUMERICAL CODE

FULL HEIGHT HINGED DOOR PAIR

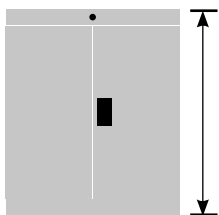

DOOR FOOTPRINT H mm**	TYPE OF CLOSURE	ART. WITH Dark Grey plastic kit	ART. NO Plastic kit*
850	P5 CODE numerical code	M 70 P075 P5 10 10 __	M 70 P075 P5 0010 __
1000	P5 CODE numerical code	M 70 P090 P5 10 10 __	M 70 P090 P50010 __
1500	P5 CODE numerical code	M 70 P140 P5 10 10 __	M 70 P140 P5 0010 __
2000	P5 CODE numerical code	M 70 P190 P5 10 10 __	M 70 P190 P5 0010 __

**HEIGHT INCLUDING TOP AND BOTTOM STRENGTHENING SHELVES



LOCKS SEE PAGE 31



*PLASTIC COLOURS SEE PAGE 1368









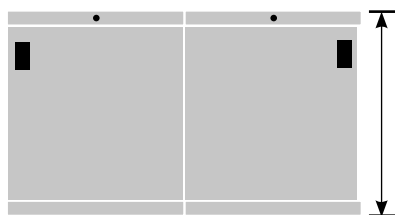





SYSTEM SR-MASTER





PAIR OF SLIDING DOORS WITH CYLINDER



DOOR FOOTPRINT H mm*	TYPE OF CLOSURE	ART. WITH Dark Grey plastic kit 	ART. NO plastic kit* 
850 (working dim. 750 mm)	 C0 KEY cylinder lock	M 30 P075 C0 10 31 _ _	M 30 P075 C0 00 31 _ _
	 C1 KEY cylinder lock	M 30 P075 C1 10 31 _ _	M 30 P075 C1 00 31 _ _
	 C2 KEY cylinder lock	M 30 P075 C2 10 31 _ _	M 30 P075 C2 00 31 _ _
1000 (working dim. 900 mm)	 C0 KEY cylinder lock	M 30 P090 C0 10 31 _ _	M 30 P090 C0 00 31 _ _
	 C1 KEY cylinder lock	M 30 P090 C1 10 31 _ _	M 30 P090 C1 00 31 _ _
	 C2 KEY cylinder lock	M 30 P090 C2 10 31 _ _	M 30 P090 C2 00 31 _ _
1500 (working dim. 1400 mm)	 C0 KEY cylinder lock	M 30 P140 C0 10 31 _ _	M 30 P140 C0 00 31 _ _
	 C1 KEY cylinder lock	M 30 P140 C1 10 31 _ _	M 30 P140 C1 00 31 _ _
	 C2 KEY cylinder lock	M 30 P140 C2 10 31 _ _	M 30 P140 C2 00 31 _ _
2000 (working dim. 1900 mm)	 C0 KEY cylinder lock	M 30 P190 C0 10 31 _ _	M 30 P190 C0 00 31 _ _
	 C1 KEY cylinder lock	M 30 P190 C1 10 31 _ _	M 30 P190 C1 00 31 _ _
	 C2 KEY cylinder lock	M 30 P190 C2 10 31 _ _	M 30 P190 C2 00 31 _ _

**HEIGHT INCLUDING TOP AND BOTTOM STRENGTHENING SHELVES

PAIR OF SLIDING DOORS WITH CYLINDER

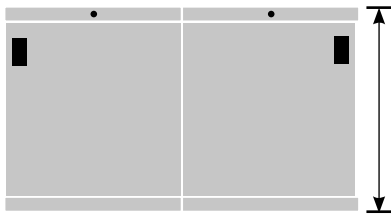

DOOR FOOTPRINT H mm*	TYPE OF CLOSURE	ART. WITH Dark Grey plastic kit	ART. NO plastic kit*
850 (working dim. 750 mm)	C0 KEY cylinder lock	M 50 P075 C0 10 31 _ _	M 50 P075 C0 00 31 _ _
	C1 KEY cylinder lock	M 50 P075 C1 10 31 _ _	M 50 P075 C1 00 31 _ _
	C2 KEY cylinder lock	M 50 P075 C2 10 31 _ _	M 50 P075 C2 00 31 _ _
1000 (working dim. 900 mm)	C0 KEY cylinder lock	M 50 P090 C0 10 31 _ _	M 50 P090 C0 00 31 _ _
	C1 KEY cylinder lock	M 50 P090 C1 10 31 _ _	M 50 P090 C1 00 31 _ _
	C2 KEY cylinder lock	M 50 P090 C2 10 31 _ _	M 50 P090 C2 00 31 _ _
1500 (working dim. 1400 mm)	C0 KEY cylinder lock	M 50 P140 C0 10 31 _ _	M 50 P140 C0 00 31 _ _
	C1 KEY cylinder lock	M 50 P140 C1 10 31 _ _	M 50 P140 C1 00 31 _ _
	C2 KEY cylinder lock	M 50 P140 C2 10 31 _ _	M 50 P140 C2 00 31 _ _
2000 (working dim. 1900 mm)	C0 KEY cylinder lock	M 50 P190 C0 10 31 _ _	M 50 P190 C0 00 31 _ _
	C1 KEY cylinder lock	M 50 P190 C1 10 31 _ _	M 50 P190 C1 00 31 _ _
	C2 KEY cylinder lock	M 50 P190 C2 10 31 _ _	M 50 P190 C2 00 31 _ _

**HEIGHT INCLUDING TOP AND BOTTOM STRENGTHENING SHELVES







LOCKS SEE PAGE 31

*PLASTIC COLOURS SEE PAGE 1368

SYSTEM SR-MASTER

ROLLER SHUTTER WITH CYLINDER LOCK







36 EH
|←→|

SHELF H mm	TYPE OF CLOSURE		ART. * 
1500 (working dim. 1400 mm)	 C0	M 30 S150 C0 00 00 __	
	 C1	M 30 S150 C1 00 00 __	
	 C2	M 30 S150 C2 00 00 __	
2000 (working dim. 1900 mm)	 C0	M 30 S200 C0 00 00 __	
	 C1	M 30 S200 C1 00 00 __	
	 C2	M 30 S200 C2 00 00 __	

*Shutters and handle exclusively supplied in grey

ROLLER SHUTTER WITH CYLINDER LOCK

54 EH
|←→|

SHELF H mm	TYPE OF CLOSURE		ART. * 
1500 (working dim. 1400 mm)	 C0	M 50 S150 C0 00 00 __	
	 C1	M 50 S150 C1 00 00 __	
	 C2	M 50 S150 C2 00 00 __	
2000 (working dim. 1900 mm)	 C0	M 50 S200 C0 00 00 __	
	 C1	M 50 S200 C1 00 00 __	
	 C2	M 50 S200 C2 00 00 __	

*Shutters and handle exclusively supplied in grey



SHUTTERS ARE COMPATIBLE WITH AND CAN BE USED IN MASTER SERIES CABINETS TOO
SEE PAGE 30

ROLLER SHUTTER WITH CYLINDER LOCK

64 EH
|←→|

SHELF H mm	TYPE OF CLOSURE	ART. *	
1500 (working dim. 1400 mm)	C0	M 60 S150 C0 00 00 __	
	C1	M 60 S150 C1 00 00 __	
	C2	M 60 S150 C2 00 00 __	
2000 (working dim. 1900 mm)	C0	M 60 S200 C0 00 00 __	
	C1	M 60 S200 C1 00 00 __	
	C2	M 60 S200 C2 00 00 __	

*Shutters and handle exclusively supplied in grey

ROLLER SHUTTER WITH CYLINDER LOCK

78 EH
|←→|

SHELF H mm	TYPE OF CLOSURE	ART. *	
1500 (working dim. 1400 mm)	C0	M 70 S150 C0 00 00 __	
	C1	M 70 S150 C1 00 00 __	
	C2	M 70 S150 C2 00 00 __	
2000 (working dim. 1900 mm)	C0	M 70 S200 C0 00 00 __	
	C1	M 70 S200 C1 00 00 __	
	C2	M 70 S200 C2 00 00 __	

*Shutters and handle exclusively supplied in grey



ROLL SHUTTER



HINGED DOOR



SLIDING DOOR

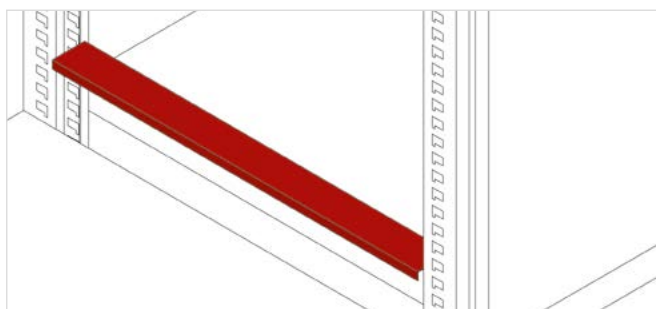

INFIL PANELS 27 EH

ART.		H mm
M 02 CP00 00 00 00 _ _		51x471x20 H

INFIL PANELS 36 EH

ART.		H mm
M 03 CP00 00 00 00 _ _		51x624x20 H

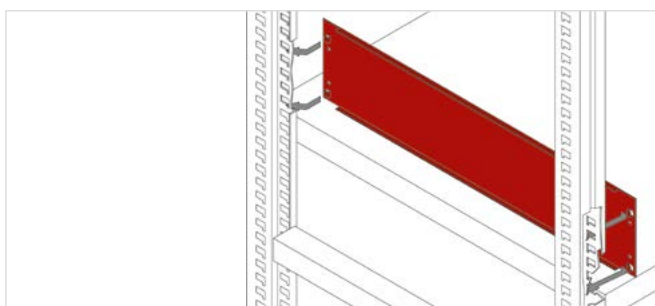

SHELF SIDE PANELS 27 EH

ART.		Dim. mm
M 02 CL15 00 00 00 _ _		567x150 H
M 02 CL20 00 00 00 _ _		567x200 H
M 02 CL25 00 00 00 _ _		567x250 H

FOR SHELVING DEPTH 573 mm

SHELF SIDE PANELS 36 EH

ART.		Dim. mm
M 03 CL15 00 00 00 _ _		720x150 H
M 03 CL20 00 00 00 _ _		720x200 H
M 03 CL25 00 00 00 _ _		720x250 H

FOR SHELVING DEPTH 726 mm

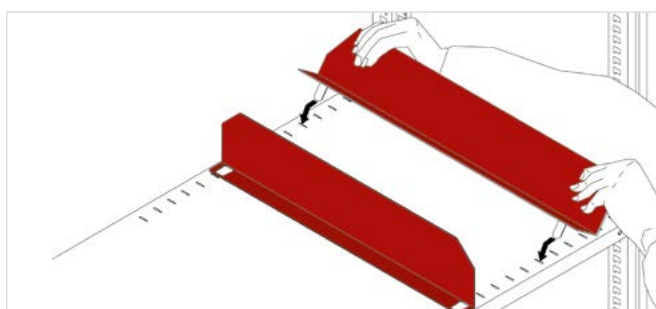

SHELF DIVIDERS 27 EH

ART.		H mm
M 02 SE10 00 00 00 _ _		100
M 02 SE15 00 00 00 _ _		150
M 02 SE20 00 00 00 _ _		200

FOR SHELVING DEPTH 573 mm

SHELF DIVIDERS 36 EH

ART.		H mm
M 03 SE10 00 00 00 _ _		100
M 03 SE15 00 00 00 _ _		150
M 03 SE20 00 00 00 _ _		200

FOR SHELVING DEPTH 726 mm



DRAWING POCKETS

ART.	Dim. mm
C MV 15 005	332x210 H DIN A4
C MV 15 006	218x148 H DIN A5

COLOUR BLACK RAL 9005



MAGNETIC SUPPORT WITH LABEL

ART.	Length mm
F ST 9997 00 00	1000

WITH LABEL AND CELLOPHANE

SPARE LABEL AND CELLOPHANE

ART.	Qty pcs
R FST 0007 00	100

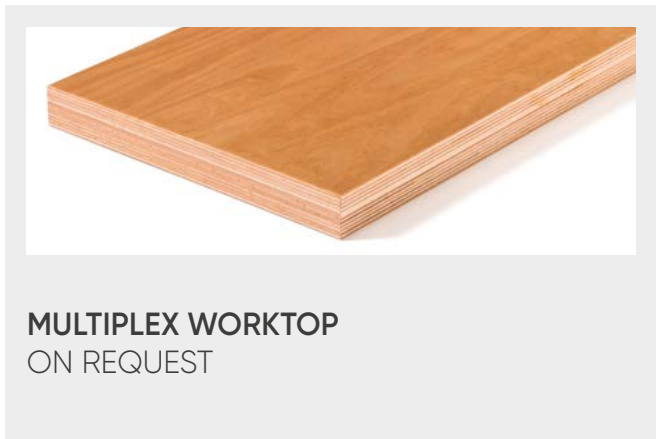

MULTIPLEX WORKTOP ON REQUEST



SPARE PARTS - FIXING

SPARE LOCK

ART. M 00 CSR0 8800 00 00

Spare lock with two keys



SPARE KEY

ART. M 00 CF00 0000 00 00

Always specify the number indicated in the cylinder lock where you wish to replace the key



MASTER KEY

ART. M 00 PF.. 0000 00 00

Available in 23 series, numbered from F 01 to F 23.

Master key seriesF 01

ART. M 00 PF01 00 00 00 00

Master key seriesF 02

ART. M 00 PF02 00 00 00 00

Master key seriesF ..

ART. M 00 PF.. 00 00 00 00

FIXING SET

ART. F SR 8999 00 99

Fixing material including (for 1 upright frame) no. 2 steel floor bolts M10x90 mm for uninterrupted concrete floors equal to or higher than class: C20/25.
Recommended traction of the plug: 5,3 kN
Plug diameter: 10 mm



SPARE HANDLE

ART. M 00 PLS0 0000 22 M0

Replacement door handle available in Dark Grey.



OTHER COLOURS
ON REQUEST



THE CABINETS MUST BE FIXED TO A FLOOR OR WALL

PARTITIONING MATERIAL



36x27 EH

SEE PAGE 107



54x27 EH

SEE PAGE 135



36x36 EH

SEE PAGE 189

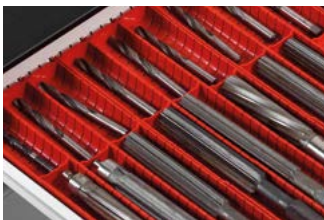

45x36 EH

SEE PAGE 211

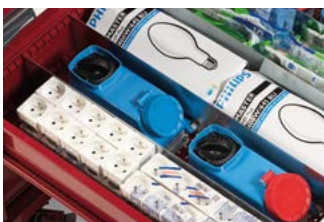

54x36 EH

SEE PAGE 237



64x36 EH

SEE PAGE 259

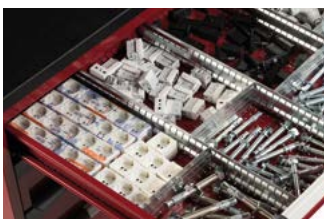

78x36 EH

SEE PAGE 281





SYSTEM SR-MASTER V3

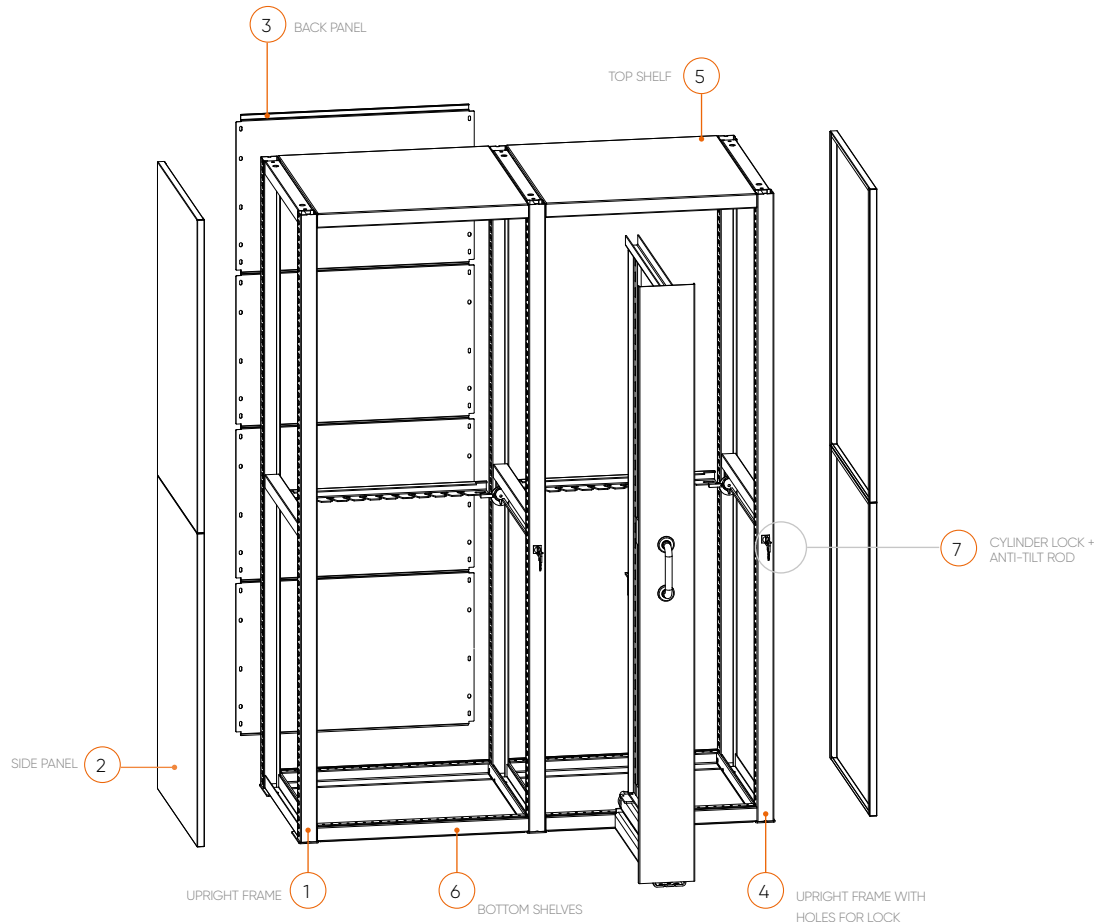

METAL COLOUR



UPRIGHT FRAMES

1	ART.		Dim. mm
	M 03 F200 00 00 01		51x726x2000 H
	M 03 F250 00 00 01		51x726x2500 H

COMPLETE WITH CLOSING CAPS

UPRIGHT FRAMES WITH HOLES FOR LOCKS

4	ART.		Dim. mm
	M 03 F200 10 00 01		51x726x2000 H
	M 03 F250 10 00 01		51x726x2500 H

COMPLETE WITH CLOSING CAPS

SIDE PANELS

2	ART.		Dim. mm
	M 03 W100 LO 00 00		23x725x1000 H
	M 03 W125 LO 00 00		23x725x1250 H
	M 03 W150 LO 00 00		23x725x1500 H

TOP SHELF

5	ART.		Dim. mm
	M 33 PV46 00 00 00		663x726x46 H

BACK PANELS

3	ART.		Dim. mm
	M 30 W200 PO 00 00		2000 H
	M 30 W250 PO 00 00		2500 H

BOTTOM SHELVES

6	ART.		Dim. mm
	M 33 PV46 10 00 00		663x726x46 H

CYLINDER LOCK (KEY) + ANTI-TILT ROD

7	ART.	TYPE OF CLOSURE
	M 33 VV00 C0 00 00 00	DIFFERENT NUMBERS
	M 33 VV00 C1 00 00 00	FOR GROUPS OF 160 NUMBERS
	M 33 VV00 C2 00 00 00	WITH IDENTICAL NUMBERS

COMPLETE WITH: 1 cylinder lock with 2 keys, 1 sheathed steel cable, 1 front pin assembly, 1 back pin assembly



CYLINDER LOCK (KEY)
The cylinder closure "C0" is supplied as standard.
"C1" or "C2" on request.
See Master section page 31

VERTICAL DRAWERS 1 SIDE STORAGE

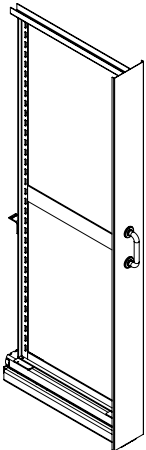

ART.	ART.	Front width mm	Usable width mm	kg
1715 mm H	2215 mm H			
F SR 3110 00 __	F SR 3310 00 __	100	68	400
F SR 3115 00 __	F SR 3315 00 __	125	93	400
F SR 3120 00 __	F SR 3320 00 __	150	118	400
F SR 3125 00 __	F SR 3325 00 __	175	143	400
F SR 3130 00 __	F SR 3330 00 __	200	168	400
F SR 3135 00 __	F SR 3335 00 __	225	193	400
F SR 3140 00 __	F SR 3340 00 __	250	212	400
Usable height mm	1715	2215		
Usable depth mm	620	620		
Front height mm	1900	2400		
For shelving height mm	2000	2500		

VERTICAL DRAWERS 2 SIDES STORAGE

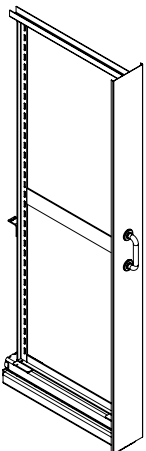

ART.	ART.	Front width mm	Usable width mm	kg
1715 mm H	2215 mm H			
F SR 3610 00 __	F SR 3810 00 __	150	68+68	400
F SR 3615 00 __	F SR 3815 00 __	175	68+93	400
F SR 3620 00 __	F SR 3820 00 __	200	93+93	400
F SR 3625 00 __	F SR 3825 00 __	200	68+118	400
F SR 3630 00 __	F SR 3830 00 __	225	93+118	400
F SR 3635 00 __	F SR 3835 00 __	225	68+143	400
F SR 3640 00 __	F SR 3840 00 __	250	118+118	400
F SR 3645 00 __	F SR 3845 00 __	250	93+143	400
F SR 3650 00 __	F SR 3850 00 __	250	68+168	400
Usable height mm	1715	2215		
Usable depth mm	620	620		
Front height mm	1900	2400		
For shelving height mm	2000	2500		

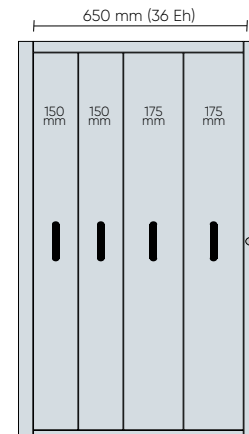
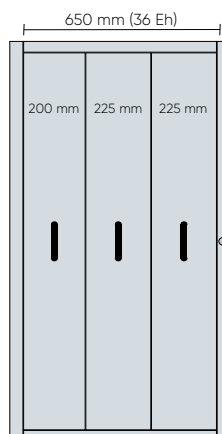
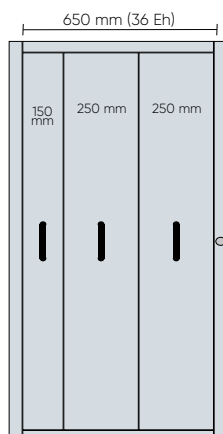

SYSTEM SR-MASTER V4

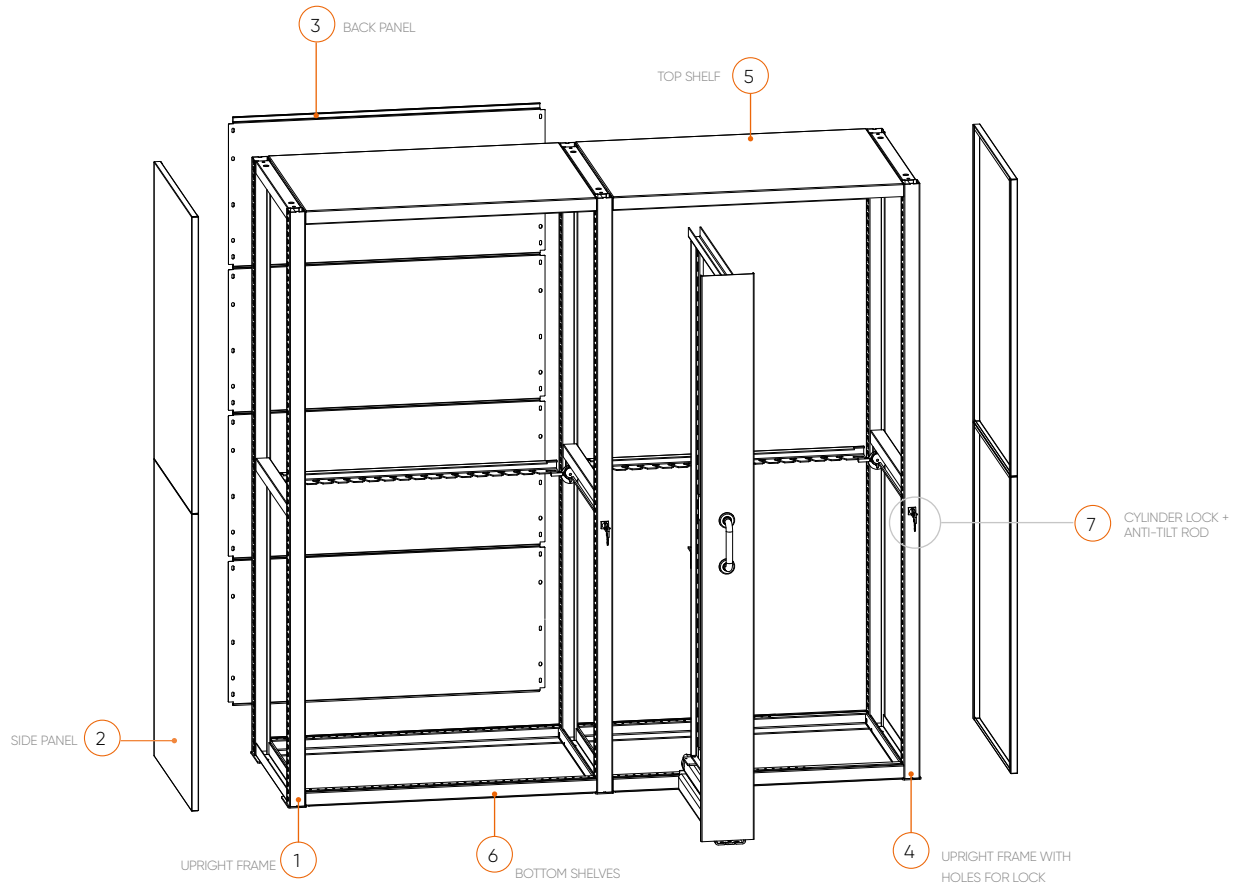

METAL COLOUR

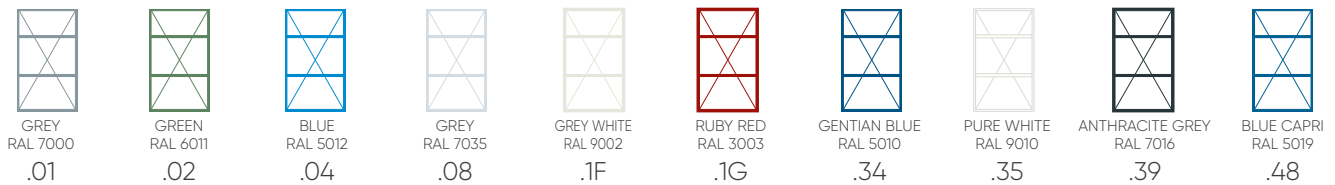

UPRIGHT FRAMES

1	ART.	Dim. mm
	M 03 F200 00 00 01 __	51x726x2000 H
	M 03 F250 00 00 01 __	51x726x2500 H

COMPLETE WITH CLOSING CAPS

UPRIGHT FRAMES WITH HOLES FOR LOCKS

4	ART.	Dim. mm
	M 03 F200 10 00 01 __	51x726x2000 H
	M 03 F250 10 00 01 __	51x726x2500 H

COMPLETE WITH CLOSING CAPS

SIDE PANELS

2	ART.	Dim. mm
	M 03 W100 L0 00 00 __	23x725x1000 H
	M 03 W125 L0 00 00 __	23x725x1250 H
	M 03 W150 L0 00 00 __	23x725x1500 H

TOP SHELF

5	ART.	Dim. mm
	M 53 PV46 00 00 00 __	969x726x46 H

BACK PANELS

3	ART.	Dim. mm
	M 50 W200 P0 00 00 __	1019x2000 H
	M 50 W250 P0 00 00 __	1019x2500 H

BOTTOM SHELVES

6	ART.	Dim. mm
	M 53 PV46 10 00 00 __	969x726x46 H

CYLINDER LOCK (KEY) + ANTI-TILT ROD

7	ART.	TYPE OF CLOSURE
	M 53 VV00 C0 00 00 00	DIFFERENT NUMBERS
	M 53 VV00 C1 00 00 00	FOR GROUPS OF 160 NUMBERS
	M 53 VV00 C2 00 00 00	WITH IDENTICAL NUMBERS

COMPLETE WITH: 1 cylinder lock with 2 keys, 1 sheathed steel cable,
1 front pin assembly, 1 back pin assembly



CYLINDER LOCK (KEY)
The cylinder closure "C0" is supplied as standard.
"C1" or "C2" on request.
See Master section page 31

VERTICAL DRAWERS 1 SIDE STORAGE

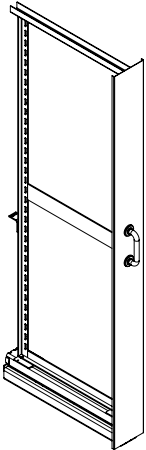

ART. 1715 mm H	ART. 2215 mm H	Front width mm	Usable width mm	kg
F SR 3110 00 __	F SR 3310 00 __	100	68	400
F SR 3115 00 __	F SR 3315 00 __	125	93	400
F SR 3120 00 __	F SR 3320 00 __	150	118	400
F SR 3125 00 __	F SR 3325 00 __	175	143	400
F SR 3130 00 __	F SR 3330 00 __	200	168	400
F SR 3135 00 __	F SR 3335 00 __	225	193	400
F SR 3140 00 __	F SR 3340 00 __	250	212	400
Usable height mm	1715	2215		
Usable depth mm	620	620		
Front height mm	1900	2400		
For shelving height mm	2000	2500		

VERTICAL DRAWERS 2 SIDES STORAGE

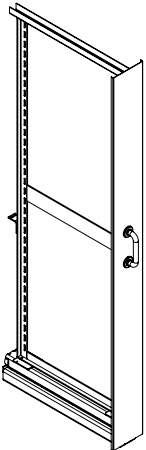

ART. 1715 mm H	ART. 2215 mm H	Front width mm	Usable width mm	kg
F SR 3610 00 __	F SR 3810 00 __	150	68+68	400
F SR 3615 00 __	F SR 3815 00 __	175	68+93	400
F SR 3620 00 __	F SR 3820 00 __	200	93+93	400
F SR 3625 00 __	F SR 3825 00 __	200	68+118	400
F SR 3630 00 __	F SR 3830 00 __	225	93+118	400
F SR 3635 00 __	F SR 3835 00 __	225	68+143	400
F SR 3640 00 __	F SR 3840 00 __	250	118+118	400
F SR 3645 00 __	F SR 3845 00 __	250	93+143	400
F SR 3650 00 __	F SR 3850 00 __	250	68+168	400
Usable height mm	1715	2215		
Usable depth mm	620	620		
Front height mm	1900	2400		
For shelving height mm	2000	2500		

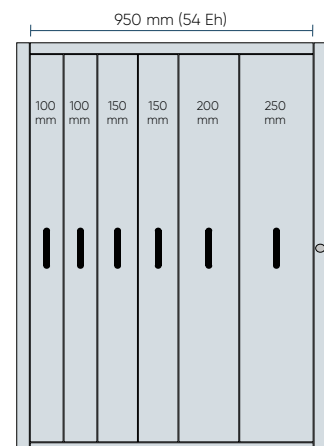
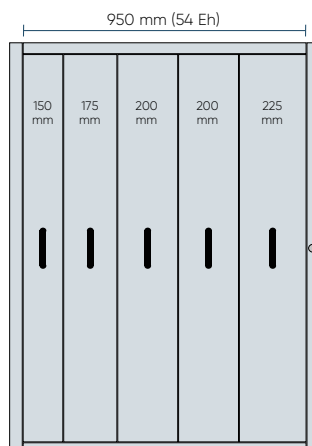
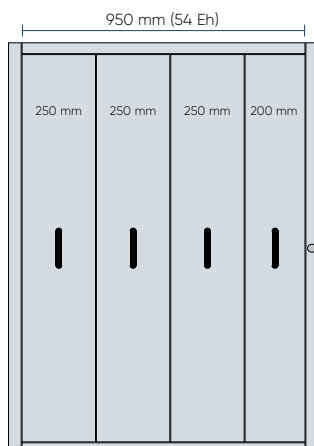

ACCESSORIES

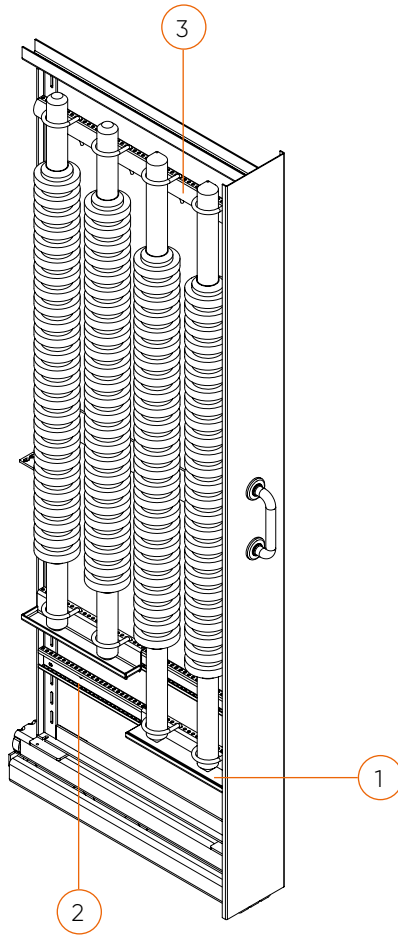

VERTICAL DRAWER
2 SIDES STORAGE

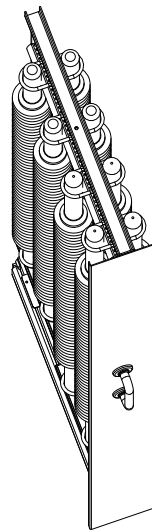

VERTICAL DRAWER
1 SIDE STORAGE

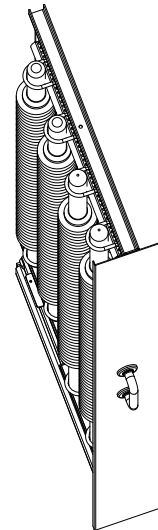

BOTTOM SHELVES WITH WOODEN INSERT

1	ART.	Dim. mm	kg
	F SR 4260 01 01	310x50	150
	F SR 4265 01 01	310x75	150
	F SR 4270 01 01	310x100	150
	F SR 4275 01 01	310x125	150
	F SR 4280 01 01	310x150	150



TRAVERSE HOLDERS

2	ART.	Dim. mm
	F CN 3010 00 01	623x28x50 H

NEOPRENE PROFILE - Colour black

3	ART.	Dim. mm
	F CN 3030 00 07	620x17x45 H



VERTICAL DRAWER
2 SIDES STORAGE

VERTICAL DRAWER
1 SIDE STORAGE

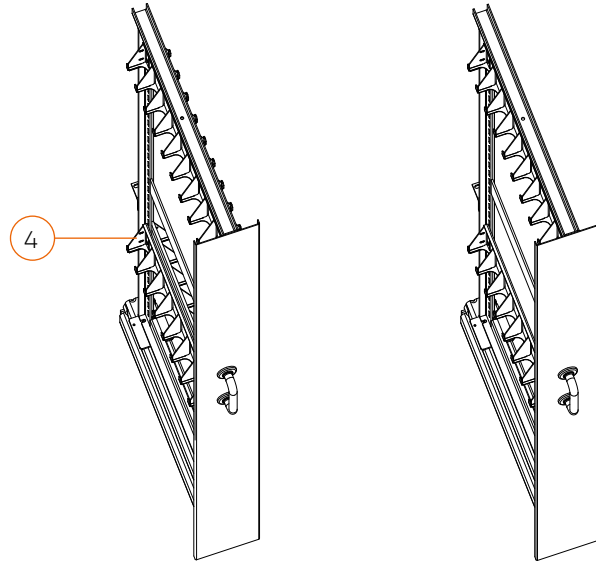

TOOL HANGING FRAME

4	ART.	for tools	flange Ø max. mm	shank Ø max. mm	tool q.ty	width mm	depth mm	for vertical drawer with usable width mm
	F CN 3210 00 01	ISO 40	63	50	9	597	56	68
	F CN 3220 00 01	ISO 45	82	63	7	597	75	93
	F CN 3230 00 01	ISO 50	98	80	5	597	84	118
	F CN 3240 00 01	ISO 50	112	80	5	597	100	118
	F CN 3250 00 01	ISO 50	98	80	6	623	84	118
	F CN 3260 00 01	ISO 55	130	89	4	597	120	143
	F CN 3270 00 01	ISO 60	160	109	3	597	140	168

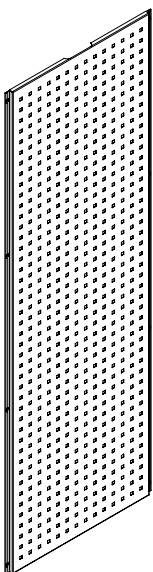

PERFORATED PANEL

ART.	Dim. mm
F SR 4210 00 01	620x500 H
F SR 4215 00 01	620x1715 H
F SR 4225 00 01	620x2215 H

ACCESSORIES

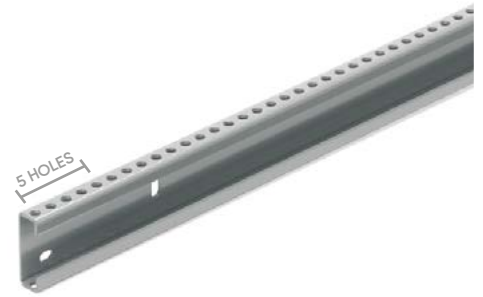
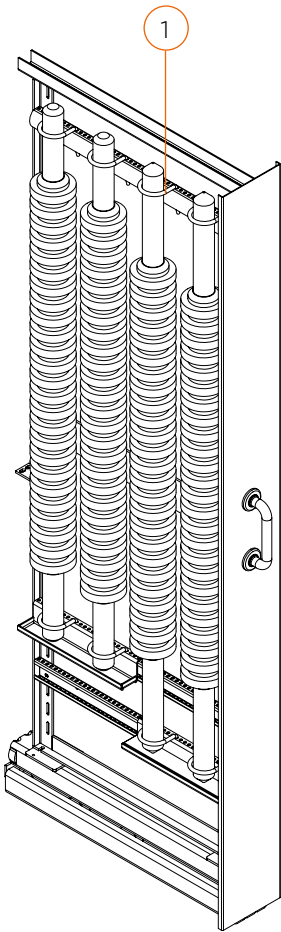

TOOL RETENTION HOLDERS

1 ART.	for tool Ø max. mm	max q.ty retention holders	hole q.ty for retention holders	
F CN 3105 00 99	15	16	3	
F CN 3110 00 99	27	12	4	
F CN 3115 00 99	35	9	5	
F CN 3120 00 99	48	8	6	
F CN 3125 00 99	60	6	7	
F CN 3130 00 99	73	6	8	
F CN 3135 00 99	85	5	9	
F CN 3140 00 99	98	4	10	
F CN 3145 00 99	110	4	11	
F CN 3150 00 99	123	4	12	
F CN 3155 00 99	135	3	13	

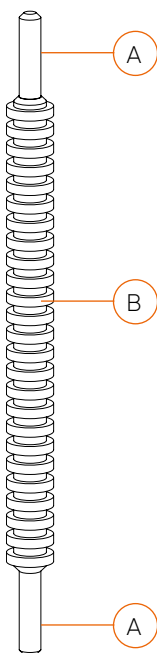

TECHNICAL DIAGRAM OF SAFETY RINGS IN VERTICAL DRAWERS

DRAWER 1 SIDE STORAGE

ART.	drawers front width	tool Ø mm (A)	tool Ø mm (B)	
F CN 3115 00 99	100	35	55	
F CN 3110 00 99	100	27	68	
F CN 3125 00 99	125	60	80	
F CN 3120 00 99	125	48	93	
F CN 3135 00 99	150	85	105	
F CN 3130 00 99	150	73	118	
F CN 3145 00 99	175	110	130	
F CN 3140 00 99	175	98	143	
F CN 3155 00 99	200	135	155	

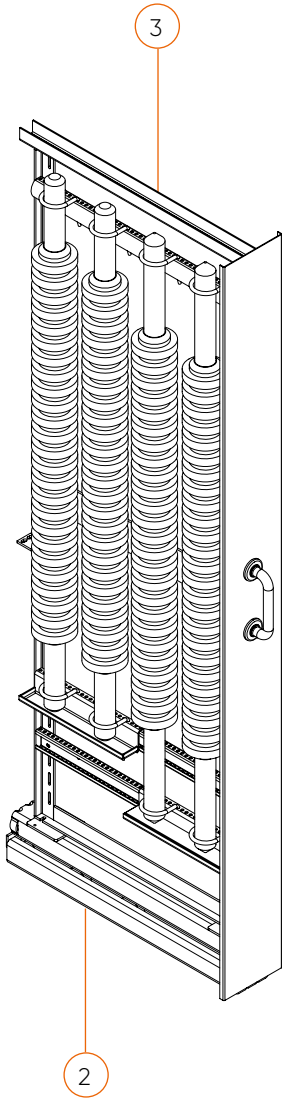

DRAWERS 2 SIDES STORAGE - LEFT HAND

ART.	drawers front width	tool Ø mm (A)	tool Ø mm (B)
F CN 3115 00 99	150	35	55
F CN 3115 00 99	150	35	55
F CN 3110 00 99	150	27	68
F CN 3115 00 99	175	35	55
F CN 3115 00 99	175	35	55
F CN 3110 00 99	175	27	68
F CN 3110 00 99	175	27	68
F CN 3125 00 99	200	60	80
F CN 3125 00 99	200	60	80
F CN 3120 00 99	200	48	93
F CN 3125 00 99	225	60	80
F CN 3125 00 99	225	60	80
F CN 3120 00 99	225	48	93
F CN 3120 00 99	225	48	93
F CN 3135 00 99	250	85	105
F CN 3135 00 99	250	85	105
F CN 3130 00 99	250	73	118

DRAWERS 2 SIDES STORAGE - RIGHT HAND

ART.	drawers front width	tool Ø mm (A)	tool Ø mm (B)
F CN 3115 00 99	150	35	55
F CN 3110 00 99	150	27	68
F CN 3110 00 99	150	27	68
F CN 3125 00 99	175	60	80
F CN 3120 00 99	175	48	93
F CN 3125 00 99	175	60	80
F CN 3120 00 99	175	48	93
F CN 3125 00 99	200	60	80
F CN 3120 00 99	200	48	93
F CN 3120 00 99	200	48	93
F CN 3135 00 99	225	85	105
F CN 3130 00 99	225	73	118
F CN 3135 00 99	225	85	105
F CN 3130 00 99	225	73	118
F CN 3135 00 99	250	85	105
F CN 3130 00 99	250	73	118
F CN 3130 00 99	250	73	118