

iMilani

innovative
italian
ideas

**TECHNOLOGY.
DYNAMISM.
PEOPLE.**

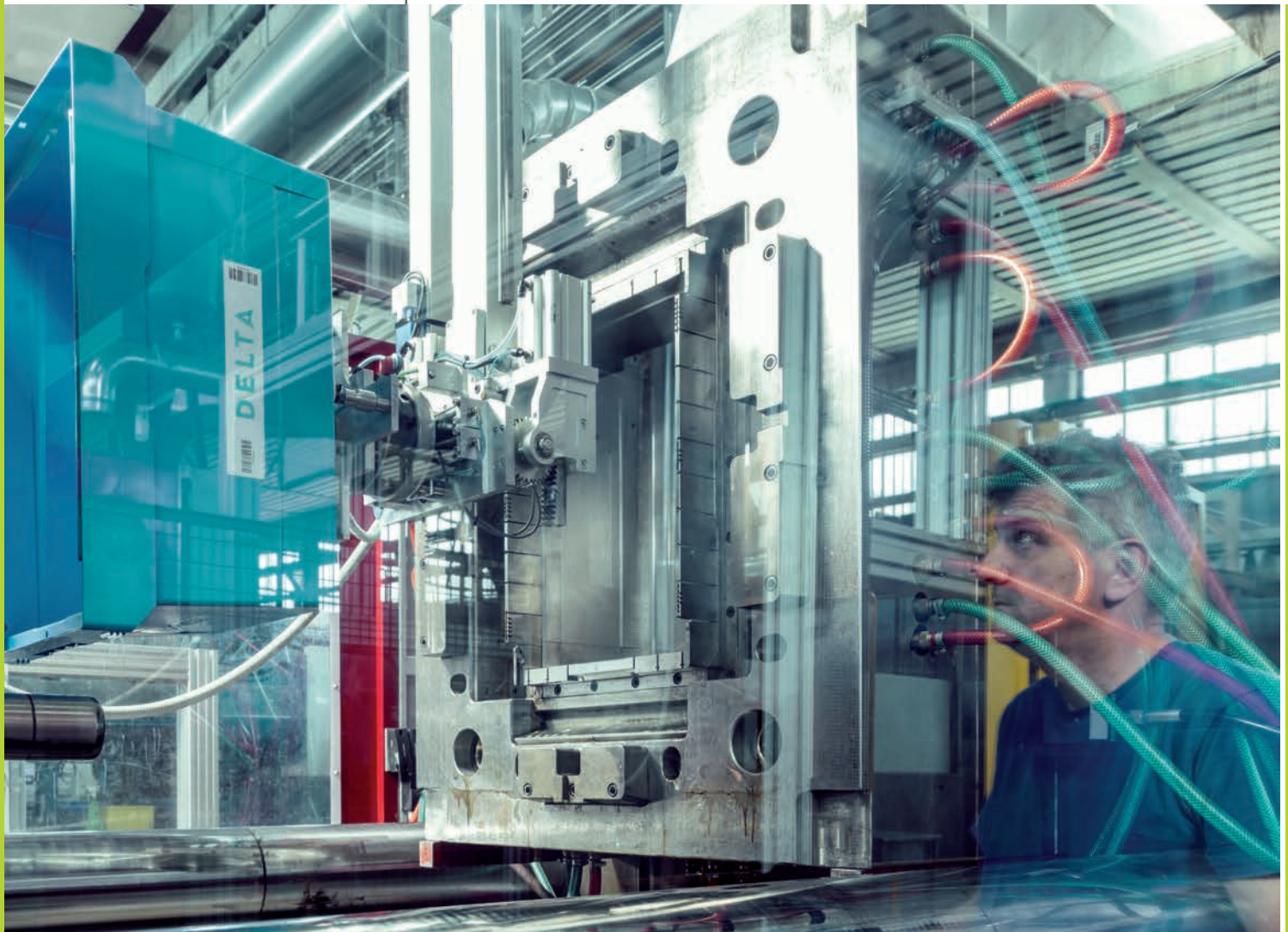

iMiCUBE

We are people who believe in quality, innovation and sustainability as essential values in business, as guides to behaviour and as the real substance of any modern vision. These are the values we rely on to inform the everyday conduct of our work, with the deep conviction that espousing them does not invite the risk being unprepared for an already imminent future, with its need for interaction, speed and mutual satisfaction between customer and supplier, who, now more than ever, are partners in the challenge for competitiveness.

These are the values of our present and our past, rooted in **the story of an enterprise begun by Mario Milani in 1929** and carried forward by Gianni Milani. It was the latter who, in 1972, had the illuminated idea of the innovative importance of plastic containers as a tool to help businesses manage space more rationally.

Now the third generation will write the next chapter of this story with iMilani CEO Roberto Milani, who envisioned this new business venture as a natural consequence of the need to enter the market with a streamlined, "open space and open mind" production process. Alongside him will be Gianluca Marzano, who, having gained valuable experience as COO of Fami, is also CEO of iMilani today.

iMilani is therefore eager to face the challenge of the present as a modern and reliable player, ready to accommodate the demands of the industrial world and of the wider community. Regarding the latter, it pursues 100% environmentally friendly policies and positions itself as an eco-sustainable company that prioritises the use of recycled and recyclable materials, within a controlled and fully internal production chain.

iMilani wants to serve customers with product lines tailored to their needs. It has thus come up with the "iMiCUBE" line, a series of boxes and containers with a wide usage spectrum and the "iMiLOG" line, a range of specialised containers designed exclusively for use with automatic systems, whether they are stacker cranes or mini-shuttles.

iMilani is ready.



Roberto Milani
CEO

Gianluca Marzano
CEO



iMiLOG

In addition to offering a wide range of boxes and containers, as well as accessories such as pallets and covers, iMilani also provides expertise in logistics automation.

In this regard, the **iMiLOG** specialist division can provide its technical staff for advice and the implementation of specific systems, using either the dedicated **SPACE** series or boxes and trays made to specific customer requirements.

iMiLOG works with leading manufacturers of logistics automation nationally and in Europe.

To request assistance from our technicians, send an email to automation@imilog.it

Our boxes are integrated with the systems of:

AUTOMHA

cassoli
AUTOMATIC MATERIAL HANDLING

CUBAR

DEMATIC

Ferretto Group
on just one provider

FRETOR
DROVEDAN
CORPORATE LIFE

JUNGHEINRICH

Logico

MECALUX

T&W
LIVING LOGISTICS

trascar
AUTOMATION and LOGISTICS

zancaner
Handling Automation & More

innovative
italian
ideas

iMilani



MATERIAL: POLYPROPYLENE AT ITS BEST

TOP QUALITY POLYPROPYLENE AND POLYPROPYLENE FOR FOOD PRODUCTS



PP

Top quality polypropylene is a non-toxic, odourless plastic that is resistant to solvents and acids. It can be washed and sterilised and is water-resistant and non-hygroscopic. Its chemical and mechanical properties make it perfect for the manufacture of boxes and containers, ideal for handling in automatic warehouses.

Food safety

Polypropylene for food use is a material that conforms to current EU legislation governing the characteristics of packaging and containers for contact with food. This plastic material is very widespread in the food industry, from product preparation and packaging to storage and shipment.



PP branching under presses.

ECOGREEN



Ecogreen is an environmentally friendly solution that gives new life to recycled plastic, derived from the re-use of post-consumption plastic waste.

CONDUCTIVE POLYPROPYLENE – ESD



Conductive polypropylene is a high-quality plastic, perfect for protection against electrostatic discharges. Boxes made from conductive polypropylene are perfect for storing and transporting sensitive electrical components.

FIREPROOF POLYPROPYLENE CLASS VO

PP VO

Fireproof polypropylene, replicable in different colours, prevents fire risks in automated warehouses and is a viable alternative where the use of traditional fire sprinkler systems is not possible.

ECOLOGY AND SUSTAINABILITY.

BECAUSE THE EARTH IS THE MOST IMPORTANT VESSEL OF ALL

ALESSIA ZECCHINI

APNEA WORLD CHAMPION
WORLD RECORD HOLDER

Alessia Zecchini

The planet is the biggest home we have. The home that someone tomorrow will live in without even having anticipated it. It is a home open to anyone. It is perfect. That's how we find it, and how we should leave when we finally go. Or even better than we found it. We want to make the same commitment also when our plastic product reaches the end of its life, meaning after 450 years. Environmental protection is a priority, not an option.

And we don't just mean our surrounding environment, but also, and above all, that expanse of water so vast that it covers over 70% of the Earth's surface: the sea.

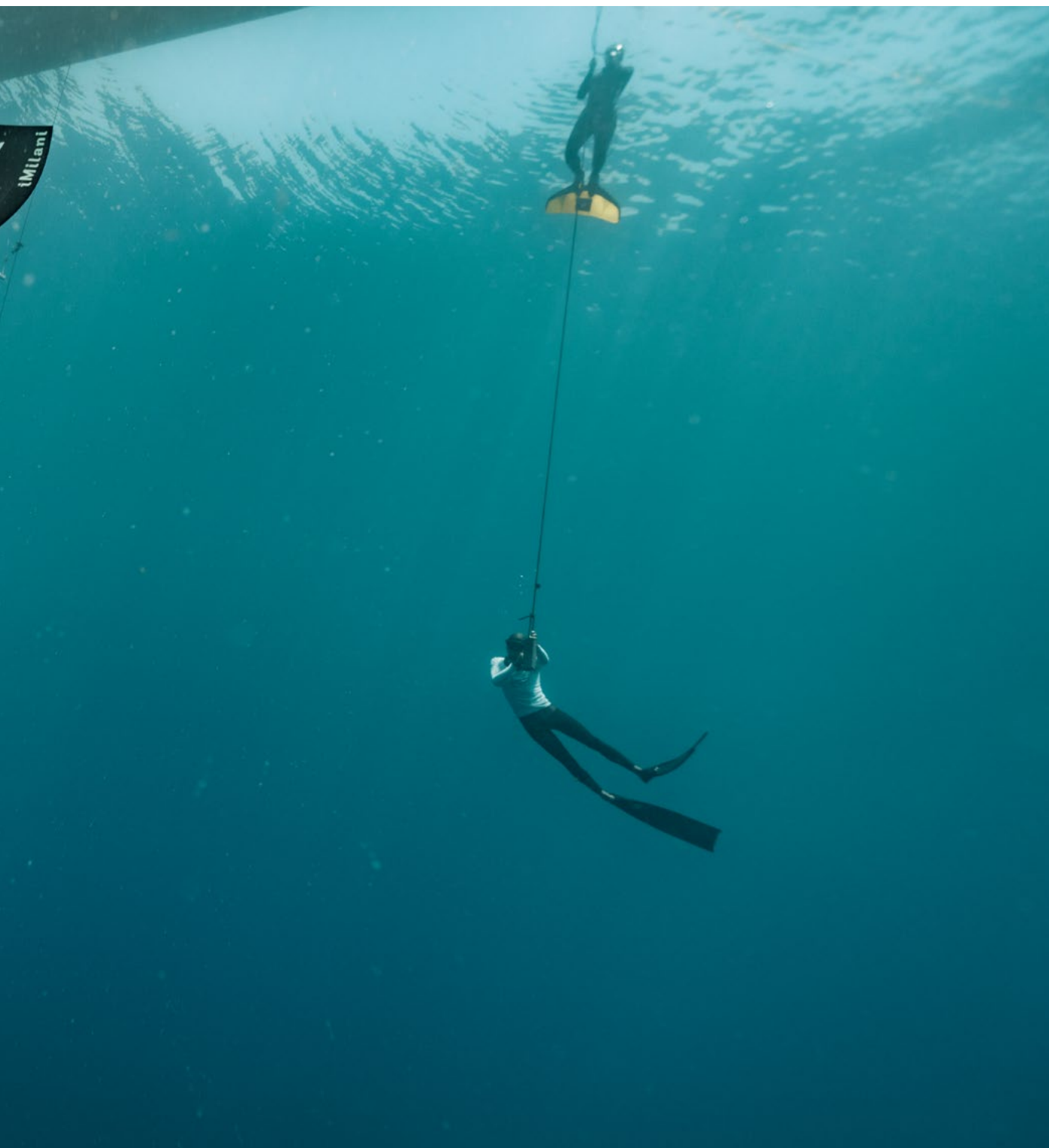

The iMilani commitment to recycling of post-consumption household plastic, involves the processing of more than 1200 tons per year: a little contribution towards a "Plastic-free Sea".

But we should not view plastic as a demon, but rather as we would the clay of the ancients, lending itself to man's imagination and taking on forms and applications useful to us in everyday life, giving rein to the imaginative project, "Plastic-free Sea".



Impact test
with pendulum.

MATERIAL CHARACTERISATION DEPARTMENT

THE RAW MATERIAL AT THE CENTRE OF OUR ATTENTION

When materials arrive at our company, the first thing they see are our laboratories. Each new arrival is carefully checked and certified according to our strict quality standards, with composition tests and mechanical, thermal and functional tests. Only materials that pass these tests are placed in our silos.

When the products have been moulded and the plastic has stabilised, this is the time for further tests: bottom bending and box structure resilience. Only after this process takes place products are released from the plant and sent to customers.

MELT FLOW TESTER

This is a testing machine that determines the Melt Flow Rate of plastic, in other words the fluidity properties of the raw material in accordance with ASTM and ISO international standards.

This value is extremely important during the raw material transformation phase, because thermoplastic materials are processed under pressure and at a certain temperature. The ability of these melted materials to flow under pressure at a certain temperature is essential to the science and technology behind polymers.

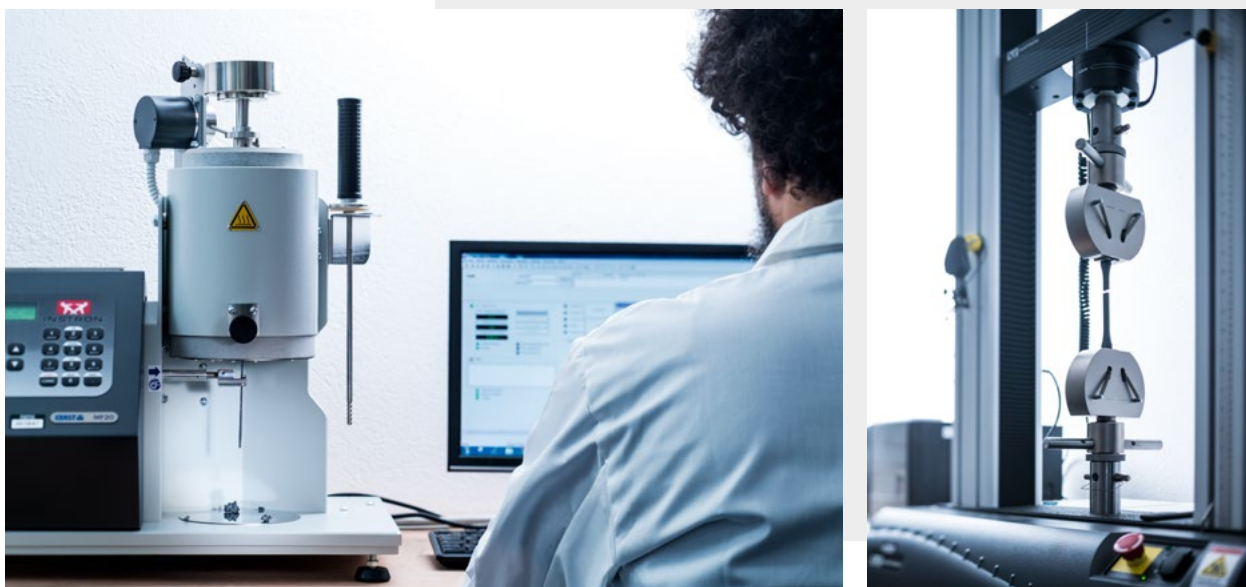

Melt Flow Tester.

TRACTION TEST

During the product design phase, we need to optimise the usage of materials in order to create items that are strong, but also light and rigid at the same time. Two of the reference properties are elasticity and resistance to traction. The traction test is carried out using two vices that secure the extremities of specifically-shaped test pieces and subject them to traction. The test result is a value indicating the breakage or yield load of the raw material. When suitably measured with an extensometer, the test piece also provides the traction elasticity module. The machine is designed to carry out tests on a wide range of test pieces in accordance with ASTM and ISO international standards.

IMPACT TEST WITH PENDULUM

For users of the materials, impact resistance is one of the most important properties. It provides an efficient assessment of the cost/performance ratio during product development and quality control.

Because components might yield when subjected to a force that is lesser than the critical breakage force, it is necessary to accurately determine the propagation of fractures following an impact. The pendulum machine is designed to carry out Charpy and Izod type tests on a wide range of test pieces in accordance with ASTM and ISO international standards.



MOULD DEPARTMENT

THE MOST INNOVATIVE INJECTION MOULDING IS MADE IN IMILANI

18 injection moulds operating on **3 shifts**.
From the moulding of small parts to boxes sized 800 x
600 mm. The moulds are designed for the application

of labels with an IML In-Mould Labelling system. This
is used both for customisation and the application of
barcodes, on-machine weighing and tolerance testing.

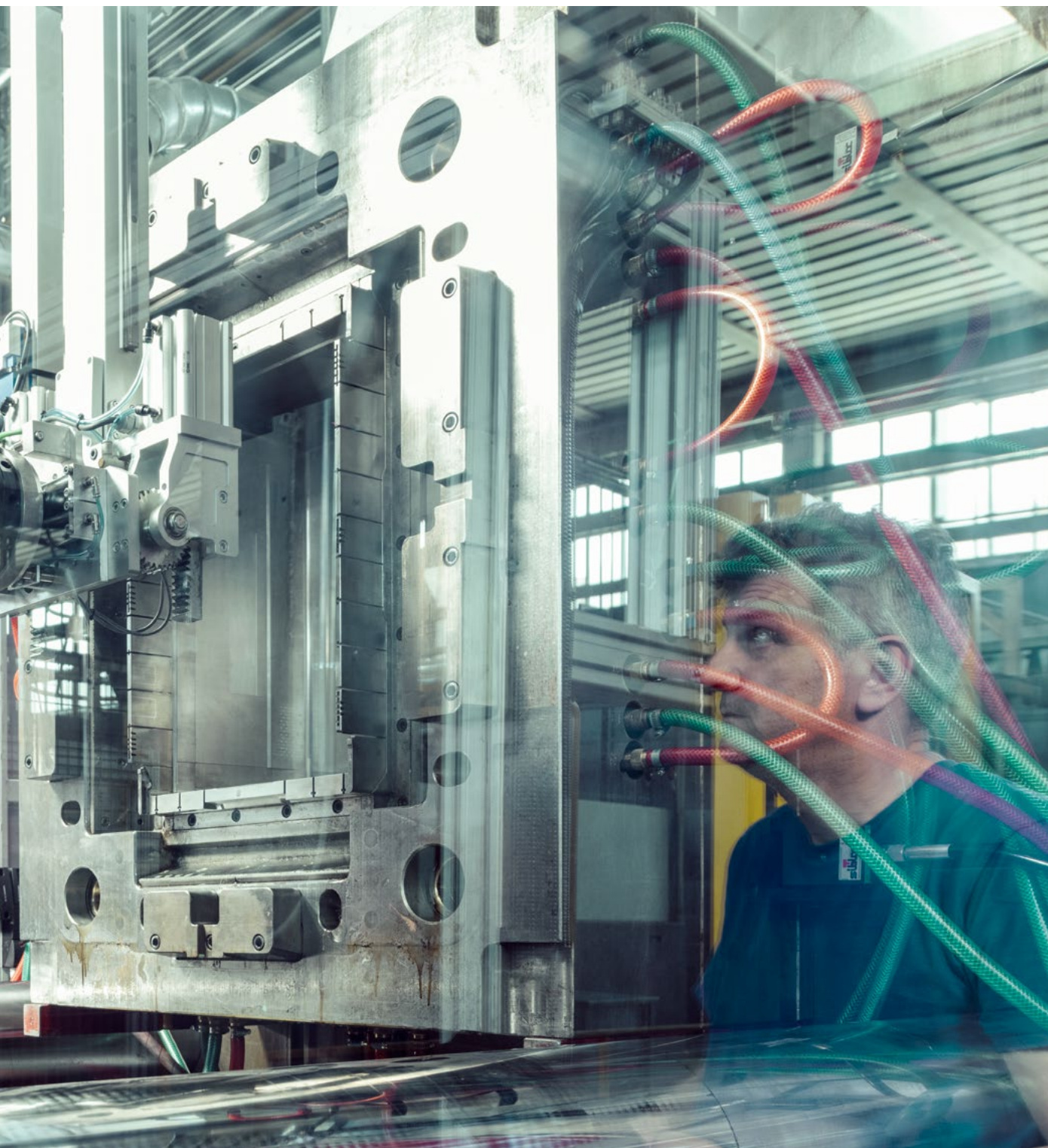

THE PROCESS

The mixture of various “grains” and colours is heated until a homogeneous and mouldable paste is achieved. This is then inserted into the mould to create a product in the desired shape: a box, a finishing element or a mechanical part. The presses and moulds are connected via silos, rollers, testing positions, and

technical and commercial information systems making up the company’s control and value chain. At the end of the process each product is tested and checked to ensure that there are no imperfections. The product is delivered to the customer only if it is just perfect.



PP 2X signal yellow RAL 1003	PP 05 yellow RAL 1021	PP 1C melon yellow RAL 1028	PP HE signal orange RAL 2010	PP 24 deep orange RAL 2011
PP 2N carmine RAL 3002	PP 1G ruby red RAL 3003	PP 03 red RAL 3020	PP JV signal purple RAL 4008	PP 3Z telemagenta RAL 4010
PP 04 blue PANTONE 660C	PP XB turquoise PANTONE 2925C	PP 3P aqua blue RAL 5021	PP 27 signal blue RAL 5005	PP IG sapphire blue RAL 5003
PP QD leaf green RAL 6002	PP JW plastic green RAL 6011	PP 43 yellowish green RAL 6018	PP 2F light green RAL 6027	PP 02 green RAL 6032
PP 1B signal grey RAL 7004	PP XL anthracite grey RAL 7016	PP 08 light grey RAL 7035	PP 01 grey RAL 7046	PP 07 black RAL 9011

 Colours on request

PERSONALISED MARKING

Steel insert integrated into the mould
Embossed marking



Hot foil printing with printing plate



 Available in all colours

INDEX

14 AUTOMOTIVE



-	R - KLT	16
-	RL - KLT	24
-	1421 - KLT	32
-	ODETTE	34
-	MATS	40
-	SAFELID	42
-	MOTION	46

128 SPACE SAVER

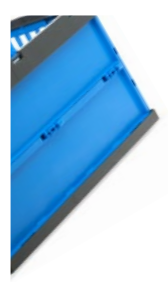

-	KRONOS	130
-	DELTA	136
-	MINERVA	142

220 STEEL



-	FOX	222
-	QUICK	236
-	FRAME	256
-	PICK	266
-	SQUARE	276

50 LOGISTICS



-	ATHENA	52
-	ATHENA LIGHT	110
-	CONTAINER	114
-	PALLET & LID	120

148 C - PARTS



-	COMPAT	150
-	PRACTIBOX	160
-	RK	180
-	ZEUS	202
-	HOLDER	208

AUTOMOTIVE

14



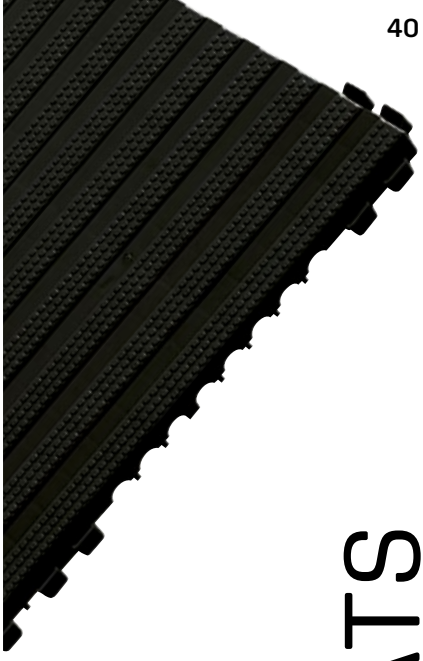

MATS

40

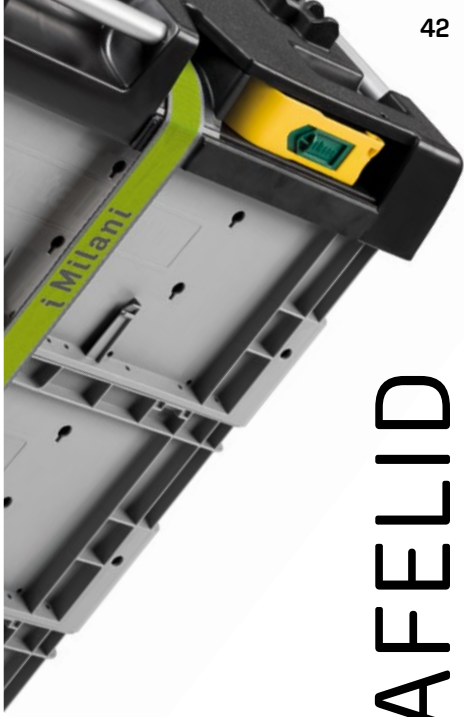

SAFELID

42

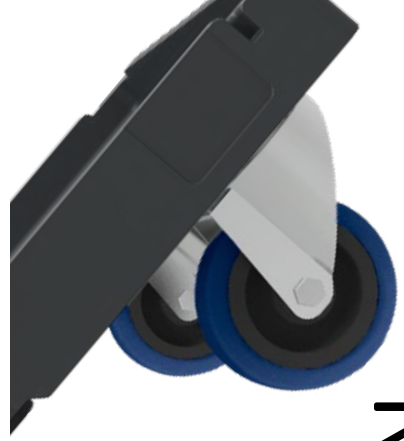

MOTION

46



R-KLT

The R-KLT series, created within the VDA - German Association of the Automotive Industry project, is ideally applied in the automotive industry, facilitating the movement of goods between the components industries and car manufacturers.

Good resistance to oils, various automated handling options, tough ergonomic handles, a high level of safety and strength and a reinforced bottom to withstand heavy loads.

BOTTOMS

300 x 200



400 x 300



600 x 400



iMiCUBE

17

label holders
on both sides



slot



600 mm



300 mm + 300 mm



hand grip



slot for vertical bracing

stackable upper edge

label holder

ergonomic handle

stackable lower edge

reinforced bottom

centring hole

stable gripping surface
for extraction in autom. warehouses

guides for frontal handling



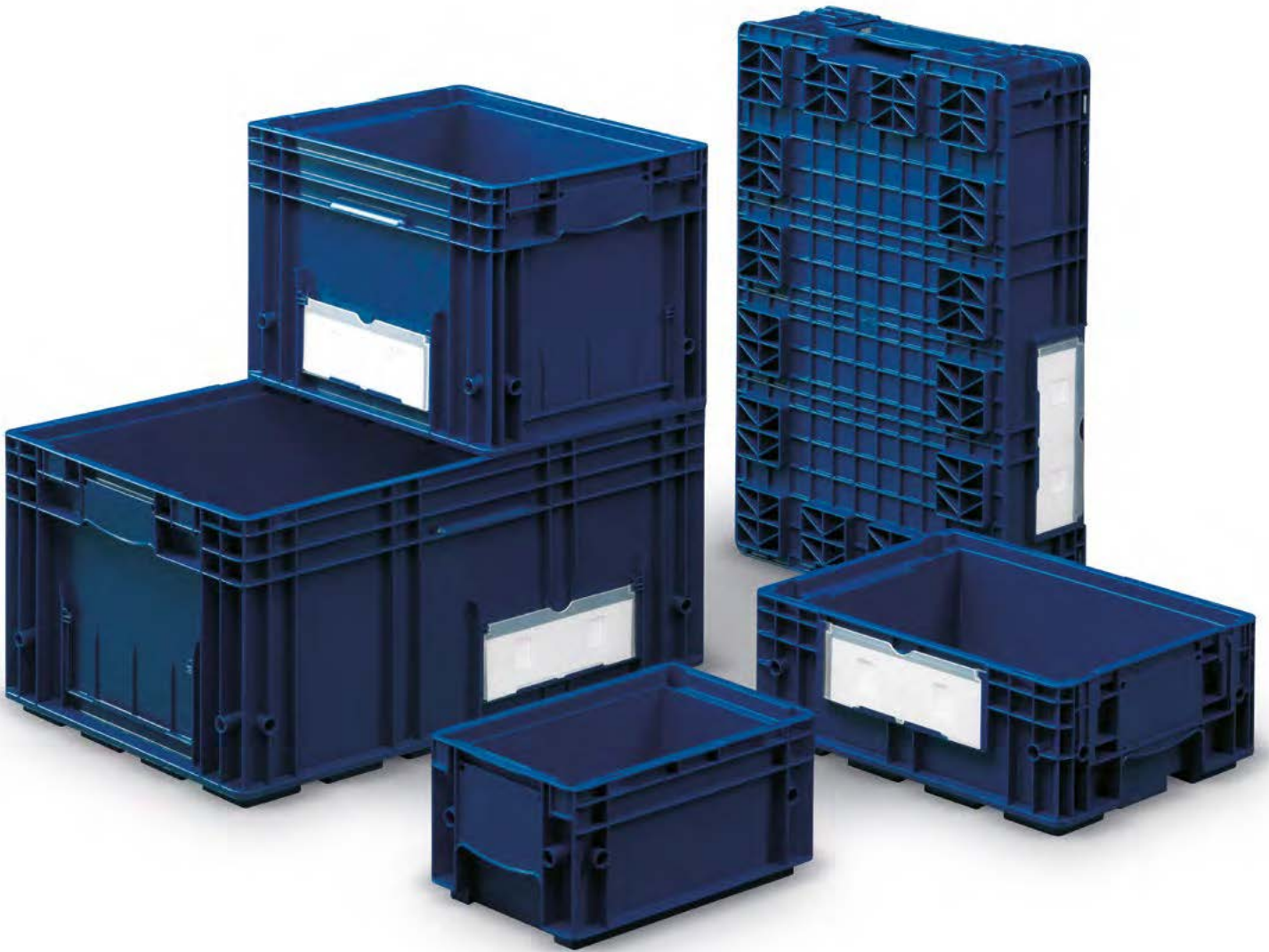

300 x 200 mm H 147 mm

	ARTICLE	WALLS		BOTTOM			HANDLES		GR.	PACKAGING		UNIT PRICE €
		Closed	Perforated	Closed	Perforated	Reinforced	Closed	Open		Qty. per pack.	Qty. per pallet	
A	KL 3215 511G	■		■			■		570	16	256	
B	KL LI35 511G								91	8	1280	
ARTICLE ON REQUEST												
A	KL 3215 5207	■		■			■		638	16	256	
B	KL LI35 5207								102	8	1280	
ACCESSORIES												
C	KL PROT 5100								25	8		

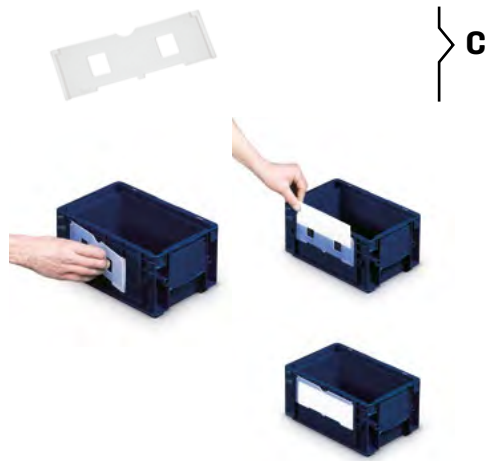
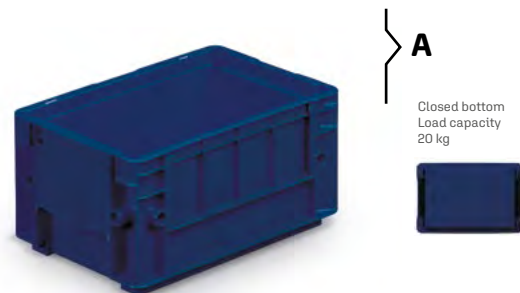

DATASHEET

A	
Stacked edge height	132 mm
Usable stacked height / with lid	127 mm/ 116 mm
Usable internal dimensions	243 x 161 x 142H mm
Volume	5.3 litres
Pieces per pack / pallet	16 256
Package dimensions	620 x 420 x 563H mm
Pallet dimensions	1200 x 800 x 2277H mm
B	
Lid	300 x 200 mm
Pieces per pack. / dimension	8 / 300 x 200 x 150H mm
Pieces per pallet / dimension	1280 / 1200 x 800 x 1000H mm
C	
Semi-opaque label protection	150 x 67H mm
Pieces per pack	8

ARTICLES ON REQUEST
 Minimum order200 boxes
 Delivery guaranteed within..... 6 weeks

iMilani srl reserves the right to alter the characteristics of products without notice. The values shown are nominal, with a +/- 1% tolerance for size, depending on the material, and a +/- 3% for weight.

ARTICLE	WALLS		BOTTOM			HANDLES		GR.	PACKAGING		UNIT PRICE €
	Closed	Perforated	Closed	Perforated	Reinforced	Closed	Open		Qty. per pack.	Qty. per pallet	
A KL 4315 511G	■				■	■		1290	8	128	
B KL LI45 511G								279	4	640	
ARTICLE ON REQUEST											
A KL 4315 5207	■				■	■		1445	8	128	
B KL LI45 5207								312	4	640	
ACCESSORIES											
C KL PROT 5100								25	8		

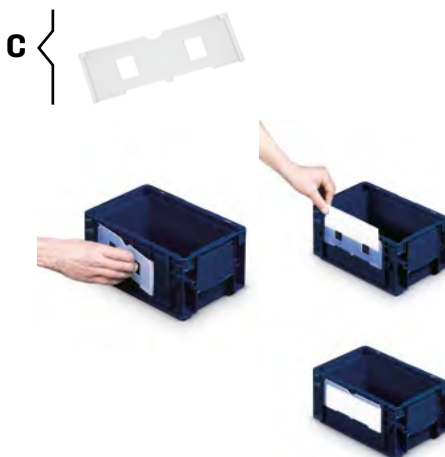
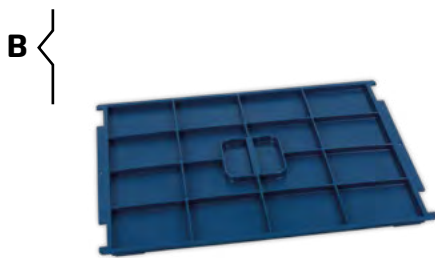

A	
Stacked edge height	132 mm
Usable stacked height / with lid	110 mm / 98 mm
Usable internal dimensions	345 x 264 x 124H mm
Volume	10 litres
Pieces per pack / pallet	8 128
Package dimensions	620 x 420 x 563H mm
Pallet dimensions	1200 x 800 x 2277H mm
B	
Lid	400 x 300 mm
Pieces per pack. / dimension	4 / 400 x 300 x 100H mm
Pieces per pallet / dimension	640 / 1200 x 800 x 1000H mm
C	
Semi-opaque label protection	150 x 67H mm
Pieces per pack	8

ARTICLES ON REQUEST

Minimum order200 boxes
Delivery guaranteed within.....6 weeks

400 x 300 mm H 280 mm

	ARTICLE	WALLS		BOTTOM			HANDLES		GR.	PACKAGING		UNIT PRICE €
		Closed	Perforated	Closed	Perforated	Reinforced	Closed	Open		Qty. per pack.	Qty. per pallet	
A	KL 4329 51IG	■				■	■		1850	4	64	
B	KL LI45 51IG								279	4	640	
ARTICLE ON REQUEST												
A	KL 4329 5207	■				■	■		2072	4	64	
B	KL LI45 5207								312	4	640	
ACCESSORIES												
C	KL PROT 5100								25	8		

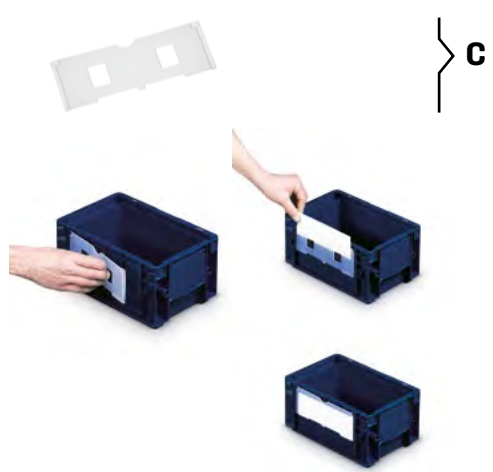
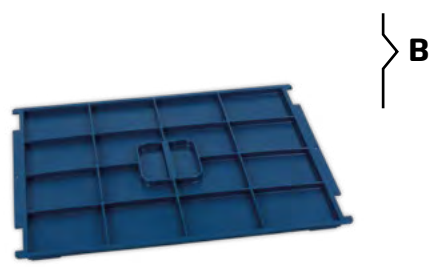

DATASHEET

A	
Stacked edge height	265 mm
Usable stacked height / with lid	243 mm/ 231 mm
Usable internal dimensions	345 x 264 x 257H mm
Volume	22 litres
Pieces per pack / pallet	4 64
Package dimensions	620 x 420 x 565H mm
Pallet dimensions	1200 x 800 x 2285H mm
B	
Lid	400 x 300 mm
Pieces per pack. / dimension	4 / 400 x 300 x 100H mm
Pieces per pallet / dimension	640 / 1200 x 800 x 1000H mm
C	
Semi-opaque label protection	150 x 67H mm
Pieces per pack	8

ARTICLES ON REQUEST
 Minimum order200 boxes
 Delivery guaranteed within..... 6 weeks

iMilani srl reserves the right to alter the characteristics of products without notice. The values shown are nominal, with a +/- 1% tolerance for size, depending on the material, and a +/- 3% for weight.

	ARTICLE	WALLS		BOTTOM			HANDLES		GR.	PACKAGING		UNIT PRICE €
		Closed	Perforated	Closed	Perforated	Reinforced	Closed	Open		Qty. per pack.	Qty. per pallet	
	A KL 6415 51IG	■				■	■		2100	4	64	
	B KL LI65 51IG								680	4	240	
ARTICLE ON REQUEST												
	A KL 6415 5207	■				■	■		2352	4	64	
	B KL LI65 5207								762	4	240	
ACCESSORIES												
	C KL PROT 5100								25	8		

A

Reinforced bottom
Load capacity
20 kg



B

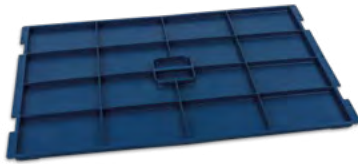

C



A

Stacked edge height	132 mm
Usable stacked height / with lid	110 mm/ 98 mm
Usable internal dimensions	543 x 363 x 124H mm
Volume	22 litres
Pieces per pack / pallet	4 64
Package dimensions	620 x 420 x 563H mm
Pallet dimensions	1200 x 800 x 2277H mm

B

Lid	600 x 400 mm
Pieces per pack. / dimension	4 / 600 x 400 x 100H mm
Pieces per pallet / dimension	240 / 1200 x 800 x 1000H mm

C

Semi-opaque label protection	150 x 67H mm
Pieces per pack	8

ARTICLES ON REQUEST

Minimum order200 boxes
Delivery guaranteed within.....6 weeks

600 x 400 mm H 280 mm

ARTICLE	WALLS		BOTTOM			HANDLES		GR.	PACKAGING		UNIT PRICE €
	Closed	Perforated	Closed	Perforated	Reinforced	Closed	Open		Qty. per pack.	Qty. per pallet	
A KL 6429 51IG	■				■	■		2970	2	32	
B KL LI65 51IG								680	4	240	
ARTICLE ON REQUEST											
A KL 6429 5207	■				■	■		3326	2	32	
B KL LI65 5207								762	4	240	
ACCESSORIES											
C KL PROT 5100								25	8		



A
Reinforced bottom
Load capacity
20 kg

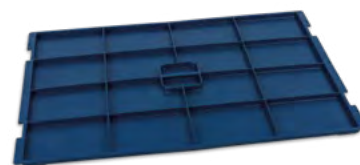

B



C

DATASHEET

A	
Stacked edge height	265 mm
Usable stacked height / with lid	243 mm/ 231 mm
Usable internal dimensions	543 x 363 x 257H mm
Volume	48 litres
Pieces per pack / pallet	2 32
Package dimensions	620 x 420 x 565H mm
Pallet dimensions	1200 x 800 x 2285H mm
B	
Lid	600 x 400 mm
Pieces per pack. / dimension	4 / 600 x 400 x 100H mm
Pieces per pallet / dimension	240 / 1200 x 800 x 1000H mm
C	
Semi-opaque label protection	150 x 67H mm
Pieces per pack	8

ARTICLES ON REQUEST

Minimum order200 boxes
Delivery guaranteed within..... 6 weeks

iMilani srl reserves the right to alter the characteristics of products without notice. The values shown are nominal, with a +/- 1% tolerance for size, depending on the material, and a +/- 3% for weight.

iMiCUBE

24



RL-KLT

The RL-KLT series, created within the VDA - German Association of the Automotive Industry project, is ideally applied in the automotive industry, facilitating the movement of goods between the components industries and car manufacturers.

Good resistance to oils, various automated handling options, tough ergonomic handles, high level of safety and strength, smooth surface for silent transport on belts, perforations in bottom for water drainage.

BOTTOMS

300 x 200



400 x 300



600 x 400

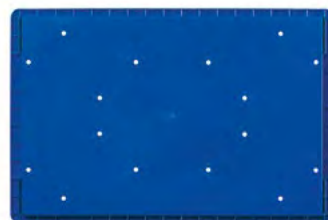

iMiCUBE

25

label holders on both sides



hand grip



holes for water drainage

stackable lower edge

slot for vertical bracing

Smooth bottom

stackable upper edge

centring hole

label holder

stable gripping surface for extraction in autom. warehouses.

ergonomic handle

guides for frontal handling

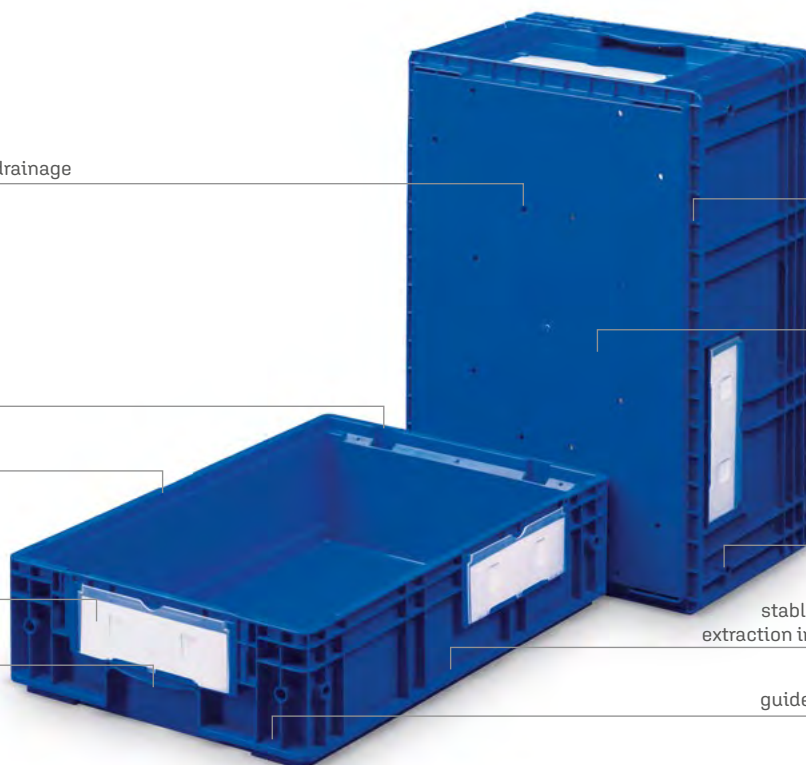



300 x 200 mm H 147 mm

	ARTICLE	WALLS		BOTTOM			HANDLES		GR.	PACKAGING		UNIT PRICE €
		Closed	Perforated	Closed	Perforated	Reinforced	Closed	Open		Qty. per pack.	Qty. per pallet	
A	KL 3147 5127	■		■			■		570	16	256	
B	KL LI35 5127								91	8	1280	
ARTICLE ON REQUEST												
A	KL 3147 5207	■		■			■		638	16	256	
B	KL LI35 5207								102	8	1280	
ACCESSORIES												
C	KL PROT 5100								25	8		

RL-KLT 3147

iMilani
27



A
Closed bottom
Load capacity
20 kg



B



C

DATASHEET

A	
Stacked edge height	132 mm
Usable stacked height / with lid	127 mm/ 116 mm
Usable internal dimensions	243 x 161 x 142H mm
Volume	5.3 litres
Pieces per pack / pallet	16 256
Package dimensions	620 x 420 x 563H mm
Pallet dimensions	1200 x 800 x 2277H mm
B	
Lid	300 x 200 mm
Pieces per pack. / dimension	8 / 300 x 200 x 150H mm
Pieces per pallet / dimension	1280 / 1200 x 800 x 1000H mm
C	
Semi-opaque label protection	150 x 67H mm
Pieces per pack	8

ARTICLES ON REQUEST
 Minimum order200 boxes
 Delivery guaranteed within..... 6 weeks

iMilani srl reserves the right to alter the characteristics of products without notice. The values shown are nominal, with a +/- 1% tolerance for size, depending on the material, and a +/- 3% for weight.

	ARTICLE	WALLS		BOTTOM			HANDLES		GR.	PACKAGING		UNIT PRICE €
		Closed	Perforated	Closed	Perforated	Reinforced	Closed	Open		Qty. per pack.	Qty. per pallet	
	A KL 4147 5127	■			■		■		1080	8	128	
	B KL LI45 5127								279	4	640	
ARTICLE ON REQUEST												
	A KL 4147 5207	■			■		■		1210	8	128	
	B KL LI45 5207								312	4	640	
ACCESSORIES												
	C KL PROT 5100								25	8		

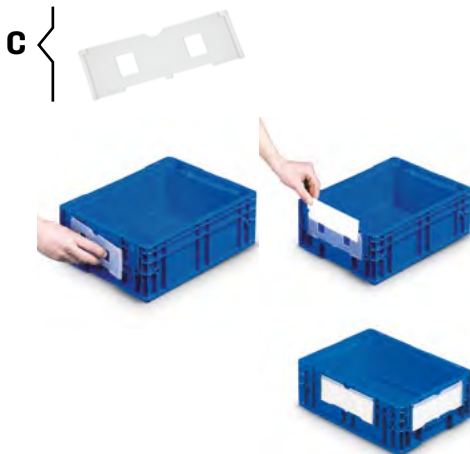

A	
Stacked edge height	132 mm
Usable stacked height / with lid	127 mm / 116 mm
Usable internal dimensions	346 x 262 x 142H mm
Volume	10 litres
Pieces per pack / pallet	8 128
Package dimensions	620 x 420 x 563H mm
Pallet dimensions	1200 x 800 x 2277H mm
B	
Lid	400 x 300 mm
Pieces per pack. / dimension	4 / 400 x 300 x 100H mm
Pieces per pallet / dimension	640 / 1200 x 800 x 1000H mm
C	
Semi-opaque label protection	150 x 67H mm
Pieces per pack	8

DATASHEET

ARTICLES ON REQUEST

Minimum order200 boxes
Delivery guaranteed within.....6 weeks

400 x 300 mm H 280 mm

	ARTICLE	WALLS		BOTTOM			HANDLES		GR.	PACKAGING		UNIT PRICE €
		Closed	Perforated	Closed	Perforated	Reinforced	Closed	Open		Qty. per pack.	Qty. per pallet	
A	KL 4280 5127	■			■		■		1700	4	64	♻️
B	KL LI45 5127								279	4	640	♻️
ARTICLE ON REQUEST												
A	KL 4280 5207	■			■		■		1904	4	64	♻️
B	KL LI45 5207								312	4	640	♻️
ACCESSORIES												
C	KL PROT 5100								25	8		♻️



A
Perforated bottom
Load capacity
20 kg



B



C

DATASHEET

A	
Stacked edge height	265 mm
Usable stacked height / with lid	260 mm/ 249 mm
Usable internal dimensions	346 x 262 x 275H mm
Volume	22 litres
Pieces per pack / pallet	📦 4 🚚 64
Package dimensions	620 x 420 x 565H mm
Pallet dimensions	1200 x 800 x 2285H mm
B	
Lid	400 x 300 mm
Pieces per pack. / dimension	📦 4 / 400 x 300 x 100H mm
Pieces per pallet / dimension	🚚 640 / 1200 x 800 x 1000H mm
C	
Semi-opaque label protection	150 x 67H mm
Pieces per pack	📦 8

ARTICLES ON REQUEST
 Minimum order200 boxes
 Delivery guaranteed within..... 6 weeks

iMilani srl reserves the right to alter the characteristics of products without notice. The values shown are nominal, with a +/- 1% tolerance for size, depending on the material, and a +/- 3% for weight.

	ARTICLE	WALLS		BOTTOM			HANDLES		GR.	PACKAGING		UNIT PRICE €
		Closed	Perforated	Closed	Perforated	Reinforced	Closed	Open		Qty. per pack.	Qty. per pallet	
	A KL 6147 5127	■			■		■		1820	4	64	
	B KL LI65 5127								680	4	240	
ARTICLE ON REQUEST												
	A KL 6147 5207	■			■		■		2038	4	64	
	B KL LI65 5207								762	4	240	
ACCESSORIES												
	C KL PROT 5100								25	8		

A

Perforated bottom
Load capacity
20 kg



B

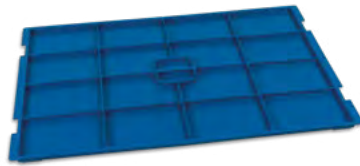

C

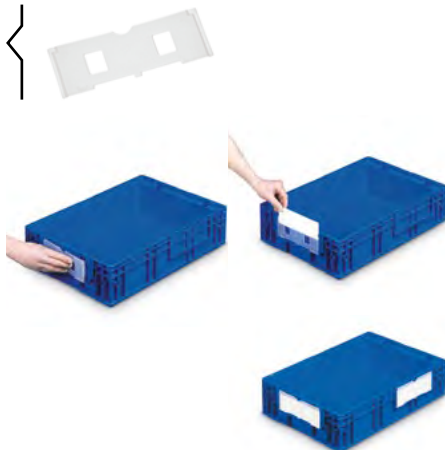

A

Stacked edge height	132 mm
Usable stacked height / with lid	127 mm / 116 mm
Usable internal dimensions	543 x 358 x 142H mm
Volume	22 litres
Pieces per pack / pallet	4 64
Package dimensions	600 x 400 x 563H mm
Pallet dimensions	1200 x 800 x 2277H mm

B

Lid	600 x 400 mm
Pieces per pack. / dimension	4 / 600 x 400 x 100H mm
Pieces per pallet / dimension	240 / 1200 x 800 x 1000H mm

C

Semi-opaque label protection	150 x 67H mm
Pieces per pack	8

ARTICLES ON REQUEST

Minimum order200 boxes
Delivery guaranteed within.....6 weeks

600 x 400 mm H 280 mm

	ARTICLE	WALLS		BOTTOM			HANDLES		GR.	PACKAGING		UNIT PRICE €
		Closed	Perforated	Closed	Perforated	Reinforced	Closed	Open		Qty. per pack.	Qty. per pallet	
A	KL 6280 5127	■			■		■		2670	2	32	
B	KL LI65 5127								680	4	240	
ARTICLE ON REQUEST												
A	KL 6280 5207	■			■		■		2990	2	32	
B	KL LI65 5207								762	4	240	
ACCESSORIES												
C	KL PROT 5100								25	8		



A
Perforated bottom
Load capacity
20 kg



B

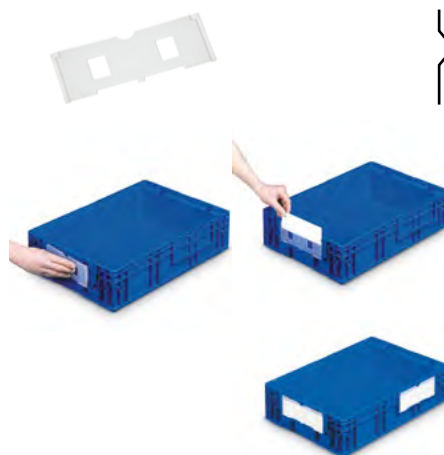

C

DATASHEET

A	
Stacked edge height	265 mm
Usable stacked height / with lid	260 mm/ 249 mm
Usable internal dimensions	543 x 358 x 275H mm
Volume	48 litres
Pieces per pack / pallet	2 32
Package dimensions	600 x 400 x 565H mm
Pallet dimensions	1200 x 800 x 2285H mm
B	
Lid	600 x 400 mm
Pieces per pack. / dimension	4 / 600 x 400 x 100H mm
Pieces per pallet / dimension	240 / 1200 x 800 x 1000H mm
C	
Semi-opaque label protection	150 x 67H mm
Pieces per pack	8

ARTICLES ON REQUEST

Minimum order200 boxes
Delivery guaranteed within..... 6 weeks

iMilani srl reserves the right to alter the characteristics of products without notice. The values shown are nominal, with a +/- 1% tolerance for size, depending on the material, and a +/- 3% for weight.

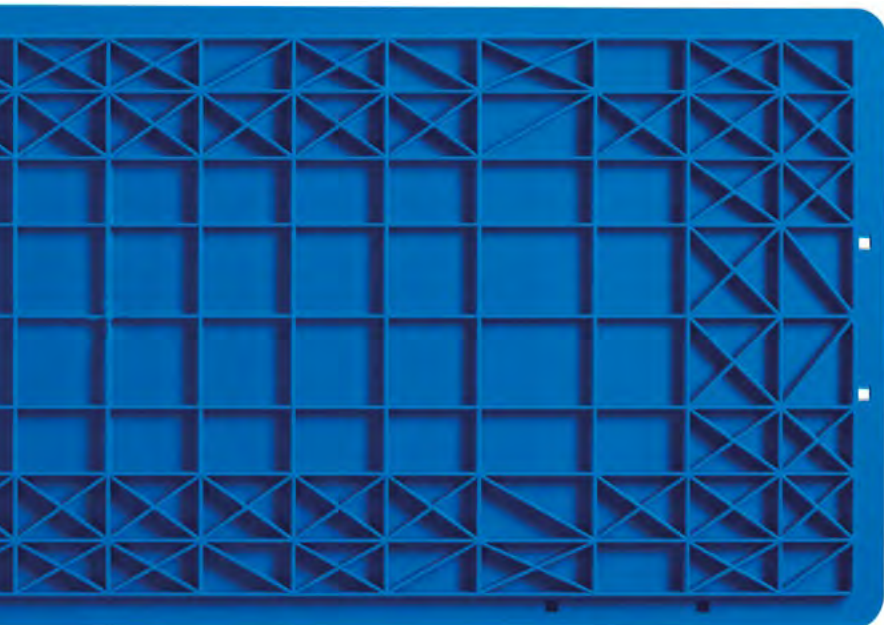

1000 x 400 mm H 214 mm

ARTICLE	WALLS		BOTTOM			HANDLES		GR.	PACKAGING		UNIT PRICE €
	Closed	Perforated	Closed	Perforated	Reinforced	Closed	Open		Qty. per pack.	Qty. per pallet	
A KL 1421 5127	■				■	■		4000	9	33	



1421 - KLT



DATASHEET

A	
Stacked edge height	199 mm
Usable stacked height / with lid	177 mm
Usable internal dimensions	935 x 345 x 191H mm
Volume	63 litres
Pieces per pack / pallet	📦 9 🚚 33
Package dimensions	1200 x 1000 x 782H mm
Pallet dimensions	1200 x 1000 x 2354h mm



ODETTE

The distinctive yellow-coloured boxes of the Odette series were designed and built under the "Odette" project (Organisation for Data Exchange by Tele Transmission in Europe). The organisation's membership includes a number of important Italian and international companies, operating in particular in the automotive industry.

The "Odette" boxes came into being thanks to close cooperation with European car makers. The "Odette" project was launched Europe-wide in 1985 to create harmonised standards for containers for the handling and transport of small volumes or amounts.

BOTTOM

reinforced bottom

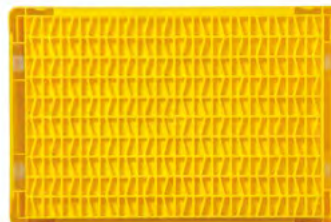
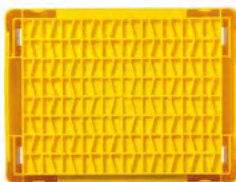

PICKING

picking from above

picking from below

side picking

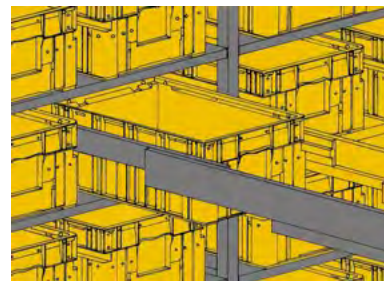
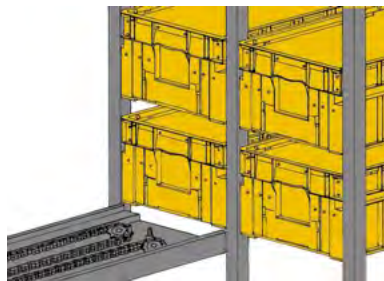
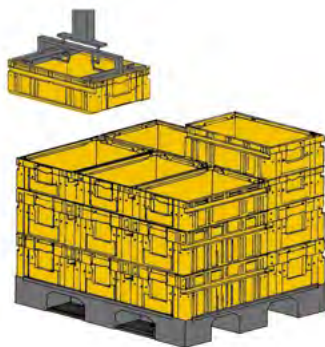

holes for vertical handling

holes for lid clips

side handle

bottom suitable for all types of roller beds

upper stacking edge

side guides for horizontal handling



guides for vertical handling

label holder



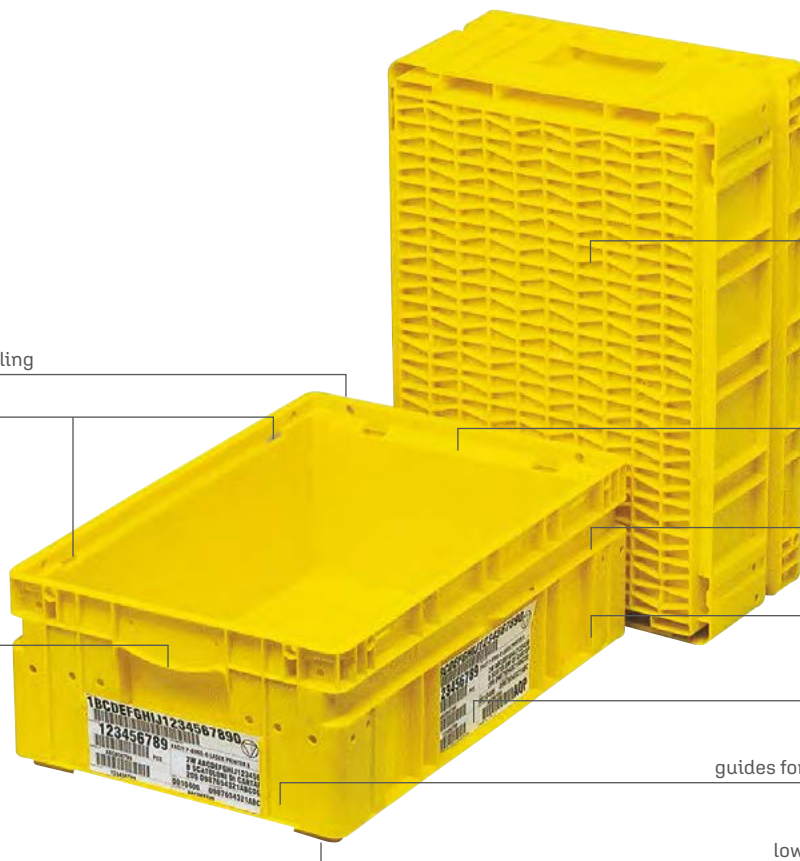

guides for frontal handling

lower stacking edge



ARTICLE	WALLS			BOTTOM			HANDLES		GR.	PACKAGING		UNIT PRICE €
	Closed	Perforated		Closed	Perforated	Reinforced	Closed	Open		Qty. per pack.	Qty. per pallet	
 A OD 4950 5105	■					■	■		600	16	256	
 B OD 32SE 5105									110	8	1440	
ACCESSORIES												
C OD BEAM 0099										8		



A	
Stacked edge height	132 mm
Usable stacked height / with lid	118 mm/ 107 mm
Usable internal dimensions	235 x 161 x 133H mm
Volume	4.6 litres
Pieces per pack / pallet	 16  256
Package dimensions	620 x 420 x 563H mm
Pallet dimensions	1200 x 800 x 2277H mm
B	
Lid	300 x 200 mm
Pieces per pack. / dimension	 8 / 300 x 200 x 160H mm
Pieces per pallet / dimension	 1440 / 1200 x 800 x 1000H mm
C	
Metal document holder rod	
Pieces per pack	 8

ARTICLES ON REQUEST



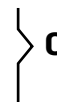
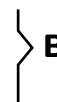

Minimum order200 boxes
Delivery guaranteed within.....6 weeks

400 x 300 mm H 214 mm

ARTICLE	WALLS		BOTTOM			HANDLES		GR.	PACKAGING		UNIT PRICE €
	Closed	Perforated	Closed	Perforated	Reinforced	Closed	Open		Qty. per pack.	Qty. per pallet	
A OD 4930 5105	■				■	■		1740	6	88	
B OD 43SE 5105							240	6	640		
ACCESSORIES											
C OD BEAM 0099									8		



DATASHEET

A	
Stacked edge height	199 mm
Usable stacked height / with lid	185 mm/ 174 mm
Usable internal dimensions	335 x 261 x 200H mm
Volume	15.8 litres
Pieces per pack / pallet	 6  88
Package dimensions	620 x 420 x 632H mm
Pallet dimensions	1200 x 800 x 2354H mm
B	
Lid	400 x 300 mm
Pieces per pack. / dimension	 6 / 400 x 300 x 120H mm
Pieces per pallet / dimension	 640 / 1200 x 800 x 1000H mm
C	
Metal document holder rod	
Pieces per pack	 8

ARTICLES ON REQUEST

Minimum order200 boxes
 Delivery guaranteed within.....6 weeks

iMilani srl reserves the right to alter the characteristics of products without notice. The values shown are nominal, with a +/- 1% tolerance for size, depending on the material, and a +/- 3% for weight.

ARTICLE	WALLS			BOTTOM			HANDLES		GR.	PACKAGING		UNIT PRICE €
	Closed	Perforated		Closed	Perforated	Reinforced	Closed	Open		Qty. per pack.	Qty. per pallet	
A OD 4910 5105	■					■	■		2820	3	44	
B OD 64SE 5105									500	3	320	
ACCESSORIES												
C OD BEAM 0099										8		





A	
Stacked edge height	199 mm
Usable stacked height / with lid	185 mm/ 174 mm
Usable internal dimensions	535 x 361 x 200H mm
Volume	34.8 litres
Pieces per pack / pallet	📦 3 🚚 44
Package dimensions	620 x 420 x 632H mm
Pallet dimensions	1200 x 800 x 2354H mm
B	
Lid	600 x 400 mm
Pieces per pack. / dimension	📦 3 / 600 x 400 x 60H mm
Pieces per pallet / dimension	🚚 320 / 1200 x 800 x 1000H mm
C	
Metal document holder rod	
Pieces per pack	📦 8

ARTICLES ON REQUEST

Minimum order200 boxes
Delivery guaranteed within.....6 weeks

600 x 400 mm H 314 mm

ARTICLE	WALLS		BOTTOM			HANDLES		GR.	PACKAGING		UNIT PRICE €
	Closed	Perforated	Closed	Perforated	Reinforced	Closed	Open		Qty. per pack.	Qty. per pallet	
A OD 4900 5105	■				■	■		4020	3	40	 
B OD 64SE 5105							500	3	320		
ACCESSORIES											
C OD BEAM 0099									8		



A
Reinforced bottom
Load capacity
20 kg









B



C

DATASHEET

A	
Stacked edge height	299 mm
Usable stacked height / with lid	285 mm/ 274 mm
Usable internal dimensions	535 x 361 x 300H mm
Volume	53 litres
Pieces per pack / pallet	 3  40
Package dimensions	620 x 420 x 648H mm
Pallet dimensions	1200 x 800 x 2369H mm
B	
Lid	600 x 400 mm
Pieces per pack. / dimension	 3 / 600 x 400 x 60H mm
Pieces per pallet / dimension	 320 / 1200 x 800 x 1000H mm
C	
Metal document holder rod	
Pieces per pack	 8

ARTICLES ON REQUEST

Minimum order200 boxes
 Delivery guaranteed within..... 6 weeks

iMilani srl reserves the right to alter the characteristics of products without notice. The values shown are nominal, with a +/- 1% tolerance for size, depending on the material, and a +/- 3% for weight.

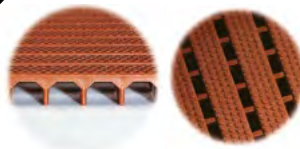

ANTI-SLIP

The particular pattern in relief on the upper part has a non-slip design, ensuring maximum grip even when wet.

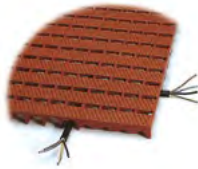

WIRING

The non-slip mats are suitable for the totally safe housing of electric cables laid on the floor.



SAFETY

The linear and corner connecting ramps increase safety for operators using trolleys, ease the rolling of wheels and improve visual characteristics for accident prevention.



CLIP

All parts can be joined and removed quickly and easily by means of the special galvanised clip system.



MATS

These mats are made of PE-LD (low density polyethylene) and are suitable especially in engineering workshops, metal processing industries, washing installations, food industries, warehouses, bathing facilities, campsites, wardrobes, etc.

The summary results of testing in the Plastics Centre of Southern Germany were as follows: the mats showed good floor adherence both in no-load and full-load conditions; they did not form bevels (which may cause the user to stumble) or large gaps. Also, they remain equally usable in damp conditions as they have a raised surface.

800 x 400 mm H 25 mm

	ARTICLE	CLOSED WALKING SURFACE	PERFORATED WALKING SURFACE	GR.	PACKAGING		UNIT PRICE €
					Qty. per pack.	Qty. per pallet	
A	CA 0804A 4101	■		1968	4	105	
	CA 0804A 4106	■		1968	4	105	
	CA 0804A 4107	■		1968	4	105	
	CA 0804A 4207	■		2339	4	105	
B	CA 0804B 4101		■	1979	4	105	
	CA 0804B 4106		■	1979	4	105	
	CA 0804B 4107		■	1979	4	105	
ACCESSORIES							
C	CA 0401A 4105	■		240	20		
	CA 0401A 4207	■		269	20		
D	CA 0101A 4105	■		68	10		
	CA 0101A 4207	■		69	10		
E	CA CLIP				10		



A

iMiCUBE
41



B



C



D

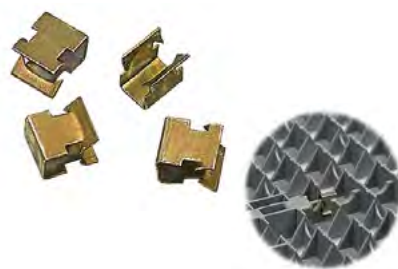

E

DATASHEET

A - CLOSED NON-SLIP MAT

Dimensions	800 x 400 x 25H mm
Walking surface	without slots
Pieces per pack / pallet	📦 4 🚚 105
Package dimensions	800 x 400 x 100H mm
Pallet dimensions	1200 x 800 x 1025H mm

B - PERFORATED NON-SLIP MAT

Dimensions	800 x 400 x 25H mm
Walking surface	with slots
Pieces per pack / pallet	📦 4 🚚 105
Package dimensions	800 x 400 x 100H mm
Pallet dimensions	1200 x 800 x 1025H mm

C - LINEAR CONNECTING RAMP FOR MAT

Dimensions	400 x 120 x 25H mm
Pieces per pack	📦 20

D - CORNER CONNECTING RAMP FOR MAT

Dimensions	120 x 120 x 25H mm
Pieces per pack	📦 10

E - GALVANISED CONNECTION CLIP

Pieces per pack	📦 10
-----------------	------

iMilani srl reserves the right to alter the characteristics of products without notice. The values shown are nominal, with a +/- 1% tolerance for size, depending on the material, and a +/- 3% for weight.



SAFE LID

SafeLid is the safest, most versatile and affordable way to secure loads during transport. Available in 3 sizes – 800x600 mm, 1200x800 mm and 1200x1000 mm – SafeLid can be supplemented with security seals, thus ensuring load

inaccessibility. Also, there is no longer any need to use stretch film, thus increasing savings in time, cost and environmental protection.

LOAD SAFETY

extendible belt extraction



positioning of fixing hook



load securing with ratchet handle



iMILANI

43

COMPONENTS

ratchet handle



lifting handle



extendible belt



SEAL





800 x 600 mm H 93 mm
1200 x 800 mm H 118 mm
1200 x 1000 mm H 100 mm

	ARTICLE	2 SHORT SIDE STRAPS	2 LONG SIDE STRAPS	2 STRAPS ATTACHABLE ON EITHER SIDE	GR.	PACKAGING		UNIT PRICE €
						Qty. per pack	Qty. per pallet	
A	SL 0806 5107	■			6150	1	60	
B	SL 1208 5107		■	■	10930	1	25	
C	SL 1210 5107		■	■	9930	1	25	



A

iMiCUBE
45



B



C

DATASHEET

A

Dimensions	822 x 618 x 93H mm
Stacked edge height	62.5 mm
Maximum load weight	2000 kg
Operating temperature	-20C° / +40C°
Strap length	2000 mm
Pieces per pack / pallet	📦 1 🚚 60
Package dimensions	850 x 650 x 120H mm
Pallet dimensions	1200 x 800 x 1980H mm

B

Dimensions	1222 x 822 x 118H mm
Stacked edge height	71 mm
Maximum load weight	2000 kg
Operating temperature	-20C° / +40C°
Strap length	2000 mm
Pieces per pack / pallet	📦 1 🚚 25
Package dimensions	1260 x 860 x 150H mm
Pallet dimensions	1250 x 850 x 1950H mm

C

Dimensions	1227 x 1027 x 100H mm
Stacked edge height	71 mm
Maximum load weight	2000 kg
Operating temperature	-20C° / +40C°
Strap length	2000 mm
Pieces per pack / pallet	📦 1 🚚 25
Package dimensions	1260 x 1060 x 130H mm
Pallet dimensions	1250 x 1100 x 1930H mm

iMilani srl reserves the right to alter the characteristics of products without notice. The values shown are nominal, with a +/- 1% tolerance for size, depending on the material, and a +/- 3% for weight.



MOTION

Motion is a trolley made of high-impact polypropylene and can be stacked when not in use.

A simple coupling system means you can create rows of trolleys with a single movement.

Available with black nylon wheels as standard.

Blue non-marking wheels, shown on this page, are available on request.

With the use of a top lid, it is also suitable for the transport of Delta boxes, stably and safely.

To facilitate the transport of multiple trolleys, a height-adjustable telescopic drawbar is provided.

COUPLING SYSTEM

The MOTION coupling system gives the option of connecting trolleys both on the short and long sides, enabling the user to shift more loads together or to prepare them for transport.



iMilani

47

STACKING

The special design of the MOTION supporting surface allows trolleys to be stacked safely and stably, with cross-positioning of the various levels.



SWIVEL WHEELS

The MOTION trolley is equipped with 4 black nylon swivel wheels as standard, 100 mm in diameter.

Upon request, it is also possible to have TPR 75 mm diameter wheels in non-marking material, as shown in the photo to the left, to help maintain the appearance of resin flooring.



BARCODE AND LOGO

A customisation option is available for a logo to be applied by hot marking on the sides of the MOTION trolley.

There is also provision for 2 protected areas on each side of the MOTION trolley for the application of barcode labels or tags; they can be supplied together with the trolleys in accordance with the customer's specifications.



innovative
italian
ideas
iMilani



Motion combination with Kronos



Motion combination with Minerva



Motion combination with KLT



Motion combination with Delta



Motion combination with Odette



Motion combination with Athena

594 x 396 mm H 173 mm

ARTICLE	NYLON WHEELS DIAM. 100 MM	GR.	PACKAGING		UNIT PRICE €
			Qty. per pack.	Qty. per pallet	
A MO 64NY 5107	■	3540	1	64	
ACCESSORIES					
1 MO HELM			1		
2 DE 64SE 5101		960	1	160	
DE 64SE 51XB		960	1	160	
3 MI 64SE 5101		1000	1	160	
MI 64SE 51XB		1000	1	160	



A

iMiCUBE
49



1



2
3

DATASHEET

A	
Dimensions	594 x 396 x 173H mm
Cross-stacked inter-axle pitch	75 mm
In-line stacked inter-axle pitch	135 mm
Height from ground	117 mm
Type of wheels	4 swivel wheels
Wheel material as a standard	black nylon
Wheel diameter	100 mm
Wheel upper plate	in galvanised steel
Maximum No. of stacked units	1 +15 trolleys
Load capacity kg	250
Pieces per pack / pallet	📦 1 🚚 64
Pallet dimensions	1200 x 800 x 1500H mm
1	
Height-adjustable telescopic drawbar	
2-3	
Lid for use with Delta/Minerva box	600 x 400 mm
Pieces per pack	📦 1
Package dimensions	620 x 420 x 100H mm

iMilani srl reserves the right to alter the characteristics of products without notice. The values shown are nominal, with a +/- 1% tolerance for size, depending on the material, and a +/- 3% for weight.

LOGISTICS

50



ATHENA



ATHENA LIGHT



114

CONTAINER



120

PALLET & LID



ATHENA

The variety of materials and sizes of the Athena series of boxes make them suitable for use in all sectors, with optimal adaptability to storage and distribution requirements. They are stackable with and without lids and conform to euro-pallet sizes.

Edges and reinforcements are designed to give the boxes structural strength to withstand the heaviest

loads. The bottoms and walls of the boxes can be closed or perforated.

The handles can also be in open or closed mode. The varied composition of these elements permits a wide range of solutions and does not exclude the option of customised solutions.

HANDLES

open handle



closed handle



WALLS

closed walls



perforated walls



LONG side wall with window



SHORT side wall with window



BOTTOMS

closed bottom



reinforced bottom

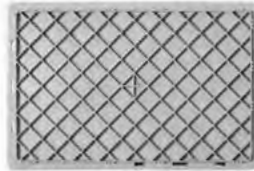

perforated bottom



800x600 mm
bottom for accessories

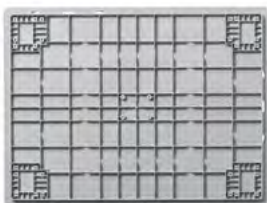

with crossbars



with feet



with wheels



LIDS

hinged



with handles



sliding



iMiCUBE

54



 Use of the lid does not exclude the option of stacking the boxes

CLOSING CLIPS

The lid of the Athena series box in the version with hinges and with handles can be closed with a sliding fastener in nylon.



closing with lead



PARTITIONED BOXES

Partitions offer a systematic way to divide Athena series boxes into two or more compartments, depending on the solution chosen. A handy dust LID is available in transparent polystyrene, fitted with a lifting grip.



COMB DIVIDERS



To organise and protect particularly delicate articles or materials that must not come into contact with other products during handling and storage, the box can be partitioned by means of comb dividers.

They are of plastic or ESD construction and are available in five heights; the dividers feature slots positioned 20 mm apart, allowing the systematic and variable subdivision of the interior space of the boxes according to the user's needs.

Dividers can be made to measure to satisfy any requirement.

INTERMEDIATE SHELF

Made of honeycomb polypropylene, the intermediate shelf acts as a separator if the box has to be divided into more than one layer. The side grooves on the lid facilitate gripping and removal.

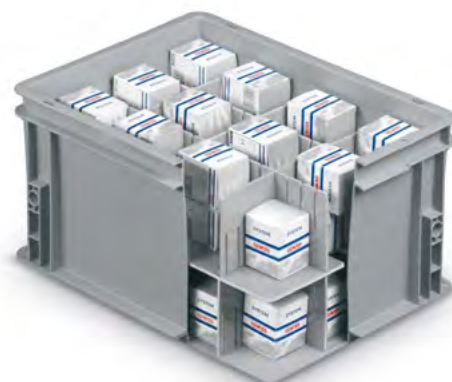
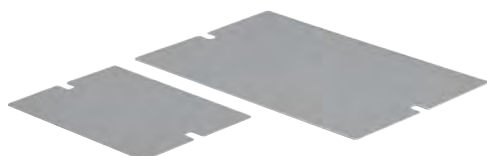

DOCUMENT HOLDER SPRING

The Document holder spring snaps onto the long or short side of the Athena box and can be used to secure transport notes or other documents.





200 x 150 mm H 150 mm

ARTICLE	WALLS		BOTTOM			HANDLES		GR.	PACKAGING		UNIT PRICE €
	Closed	Perforated	Closed	Perforated	Reinforced	Closed	Open		Qty. per pack.	Qty. per pallet	
A AT 2115A 5101	■		■			■		298	24	480	
A AT 2115A 51XB	■		■			■		298	24	480	
ARTICLE ON REQUEST											
A AT 2115A 5207	■		■			■		334	24	480	
A AT 2115A 5401	■		■			■		311	24	480	
A AT 2115A 5900	■		■			■		298	24	480	



Closed bottom
Load capacity 10 kg



DATASHEET

A	
Stacked edge height	139 mm
Usable stacked height	135 mm
Usable internal dimensions	158 x 109 x 146 H mm
Volume	2.7 litres
Pieces per pack / pallet	24 480
Package dimensions	620 x 420 x 448 H mm
Pallet dimensions	1200 x 800 x 2246 H mm

ARTICLES ON REQUEST

Minimum order200 pieces
Delivery guaranteed within.....6 weeks

iMilani srl reserves the right to alter the characteristics of products without notice. The values shown are nominal, with a +/- 1% tolerance for size, depending on the material, and a +/- 3% for weight.

Smooth bottom
Load capacity 15 kg



1



2



3



iMilani srl reserves the right to alter the characteristics of products without notice. The values shown are nominal, with a +/- 1% tolerance for size, depending on the material, and a +/- 3% for weight.

ARTICLE	WALLS		BOTTOM			HANDLES		GR.	PACKAGING		UNIT PRICE €
	Closed	Perforated	Closed	Perforated	Reinforced	Closed	Open		Qty. per pack.	Qty. per pallet	
AT 3212A 5101	■		■			■		432	16	320	
A AT 3212A 51XB	■		■			■		432	16	320	
AT 3212A 5401	■		■			■		451	16	320	
ARTICLE ON REQUEST											
A AT 3212A 5207	■		■			■		484	16	320	
A AT 3212A 5900	■		■			■		432	16	320	
ACCESSORIES											
1 AT 32HG 5101								150	10	2560	
1 AT 32HG 51XB								150	10	2560	
1 AT 32HG 5401								157	10	2560	
2 SPRING 0099	Document holder spring								10		
3 AT LOCK 8113	Pair closing clips								10		
ACCESSORY ON DEMAND											
1 AT 32HG 5207								168	10	2560	
1 AT 32HG 5900								150	10	2560	

A	
Stacked edge height	109 mm
Usable stacked height / with lid	105 mm/ 107 mm
Usable internal dimensions	259 x 160 x 116 H mm
Volume	5 litres
Pieces per pack / pallet	📦 16 🚚 320
Package dimensions	620 x 420 x 467 H mm
Pallet dimensions	1200 x 800 x 2341 H mm
1	
Hinged lid	300 x 200 mm
Pieces per package / dimension	📦 10/300 x 200 x 100 mm
Pieces per pallet / dimension	🚚 2560/1200x800x1000H mm
2	
Document holder spring	
Pieces per pack	📦 10
3	
Pair closing clips	
Pieces per pack	📦 10

ARTICLES ON REQUEST

Minimum order200 pieces
Delivery guaranteed within.....6 weeks

300 x 200 mm H 170 mm

	ARTICLE	WALLS		BOTTOM			HANDLES		GR.	PACKAGING		UNIT PRICE €	
		Closed	Perforated	Closed	Perforated	Reinforced	Closed	Open		Qty. per pack.	Qty. per pallet		
A	AT 3217A 5101	■		■			■		616	12	224		
	AT 3217A 51XB	■		■			■		616	12	224		
	AT 3217A 5401	■		■			■		644	12	224		
ARTICLE ON REQUEST													
A	AT 3217A 5207	■		■			■		690	12	224		
	AT 3217A 5900	■		■			■		616	12	224		
ACCESSORIES													
1	AT 32HG 5101								150	10	2560		
	AT 32HG 51XB								150	10	2560		
	AT 32HG 5401								157	10	2560		
2	SPRING 0099	Document holder spring								10			
3	AT LOCK 8113	Pair closing clips								10			
ACCESSORY ON DEMAND													
1	AT 32HG 5207								168	10	2560		
	AT 32HG 5900								150	10	2560		



A

iMilani
59

Smooth bottom
Load capacity 15 kg



1



2



3



DATASHEET

A	
Stacked edge height	159 mm
Usable stacked height / with lid	155 mm/ 157 mm
Usable internal dimensions	259 x 160 x 166 H mm
Volume	7 litres
Pieces per pack / pallet	📦 12 🚚 224
Package dimensions	620 x 420 x 508 H mm
Pallet dimensions	1200 x 800 x 2387 H mm
1	
Hinged lid	300 x 200 mm
Pieces per package / dimension	📦 10/300 x 200 x 100 mm
Pieces per pallet / dimension	🚚 2560/1200x800x1000H mm
2	
Document holder spring	
Pieces per pack	📦 10
3	
Pair closing clips	
Pieces per pack	📦 10

ARTICLES ON REQUEST

Minimum order200 pieces
Delivery guaranteed within.....6 weeks

iMilani srl reserves the right to alter the characteristics of products without notice. The values shown are nominal, with a +/- 1% tolerance for size, depending on the material, and a +/- 3% for weight.

innovative
italian
ideas

iMilani

ATHENA 3217

	ARTICLE	WALLS		BOTTOM			HANDLES		GR.	PACKAGING		UNIT PRICE €
		Closed	Perforated	Closed	Perforated	Reinforced	Closed	Open		Qty. per pack.	Qty. per pallet	
A	AT 4305A 5101	■		■			■		488	20	400	
	AT 4305A 51XB	■		■			■		488	20	400	
ARTICLE ON REQUEST												
A	AT 4305A 5207	■		■			■		547	20	400	
	AT 4305A 5401	■		■			■		510	20	400	
	AT 4305A 5900	■		■			■		488	20	400	



ECOGREEN



A

Closed bottom
Load capacity 15 kg



A

Stacked edge height	44 mm
Usable stacked height / with lid	40 mm/ 42 mm
Usable internal dimensions	355 x 255 x 51 H mm
Volume	3.8 litres
Pieces per pack / pallet	📦 20 🚚 400
Package dimensions	620 x 420 x 471 H mm
Pallet dimensions	1200 x 800 x 2361 H mm

DATASHEET

ARTICLES ON REQUEST

Minimum order200 pieces
Delivery guaranteed within.....6 weeks

400 x 300 mm H 55 mm

	ARTICLE	SEPARATE LID	HINGED LID	SLIDING LID	GR.	PACKAGING		UNIT PRICE €	
						Qty. per pack.	Qty. per pallet		
1	AT 43SE 5101	■			322	10	480		
	AT 43SE 51XB	■			322	10	480		
	AT 43SE 5207	■			361	10	480		
2	AT 43HG 5101		■		340	10	640		
	AT 43HG 51XB		■		340	10	640		
	AT 43HG 5207		■		381	10	640		
	AT 43HG 5401		■		355	10	640		
	AT 43HG 5900		■		340	10	640		
3	SPRING 0099	Document holder spring				10			
4	AT LOCK 8113	Pair closing clips				10			
ARTICLE ON REQUEST									
1	AT 43SE 5401	■			336	10	480		
	AT 43SE 5900	■			322	10	480		



ECOGREEN



ECOGREEN



DATASHEET

1

Separate lid	400 x 300 mm
Pieces per pack./dimension	10 / 400 x 300 x 100 H mm
Pieces per pallet / dimension	480 / 1200 x 800 x 1000 H mm

2

Hinged lid	400 x 300 mm
Pieces per pack./dimension	10 / 400 x 300 x 100 H mm
Pieces per pallet / dimension	640 / 1200 x 800 x 1000 H mm

3

Document holder spring	
Pieces per pack	10

4

Pair closing clips	
Pieces per pack	10

iMilani srl reserves the right to alter the characteristics of products without notice. The values shown are nominal, with a +/- 1% tolerance for size, depending on the material, and a +/- 3% for weight.

ARTICLE	WALLS		BOTTOM			HANDLES		GR.	PACKAGING		UNIT PRICE €
	Closed	Perforated	Closed	Perforated	Reinforced	Closed	Open		Qty. per pack.	Qty. per pallet	
AT 4308A 5101	■		■			■		516	14	280	
AT 4308A 51XB	■		■			■		516	14	280	
ARTICLE ON REQUEST											
AT 4308A 5207	■		■			■		578	14	280	
AT 4308A 5401	■		■			■		540	14	280	
AT 4308A 5900	■		■			■		516	14	280	



ECOGREEN



A

Closed bottom
Load capacity 15 kg



A

Stacked edge height	64 mm
Usable stacked height / with lid	60 mm/ 62 mm
Usable internal dimensions	355 x 255 x 71 H mm
Volume	6 litres
Pieces per pack / pallet	14 280
Package dimensions	620 x 420 x 479 H mm
Pallet dimensions	1200 x 800 x 2401 H mm

DATASHEET

ARTICLES ON REQUEST

Minimum order200 pieces
Delivery guaranteed within.....6 weeks

400 x 300 mm H 75 mm

	ARTICLE	SEPARATE LID	HINGED LID	SLIDING LID	GR.	PACKAGING		UNIT PRICE €	
						Qty. per pack.	Qty. per pallet		
1	AT 43SE 5101	■			322	10	480		
	AT 43SE 51XB	■			322	10	480		
	AT 43SE 5207	■			361	10	480		
2	AT 43HG 5101		■		340	10	640		
	AT 43HG 51XB		■		340	10	640		
	AT 43HG 5207		■		381	10	640		
	AT 43HG 5401		■		355	10	640		
	AT 43HG 5900		■		340	10	640		
3	AT 43SL 5101			■	328	10	480		
	AT 43SL 51XB			■	328	10	480		
	AT 43SL 5207			■	367	10	480		
4	SPRING 0099	Document holder spring				10			
5	AT LOCK 8113	Pair closing clips				10			
ARTICLE ON REQUEST									
1	AT 43SE 5401	■			336	10	480		
	AT 43SE 5900	■			322	10	480		
3	AT 43SL 5900			■	328	10	480		



ECOGREEN



ECOGREEN



1



2



3



4



5

DATASHEET

1	
Separate lid	400 x 300 mm
Pieces per pack./dimension	10 / 400 x 300 x 100 H mm
Pieces per pallet / dimension	480 / 1200 x 800 x 1000 H mm
2	
Hinged lid	400 x 300 mm
Pieces per pack./dimension	10 / 400 x 300 x 100 H mm
Pieces per pallet / dimension	640 / 1200 x 800 x 1000 H mm
3	
Sliding lid	400 x 300 mm
Pieces per pack./dimension	10 / 400 x 300 x 100 H mm
Pieces per pallet / dimension	480 / 1200 x 800 x 1000 H mm
4	
Document holder spring	
Pieces per pack	10
5	
Pair closing clips	
Pieces per pack	10

	ARTICLE	WALLS		BOTTOM			HANDLES		GR.	PACKAGING		UNIT PRICE €
		Closed	Perforated	Closed	Perforated	Reinforced	Closed	Open		Qty. per pack.	Qty. per pallet	
	AT 4312A 5101	■		■			■		782	8	160	
	AT 4312A 51XB	■		■			■		782	8	160	
A	AT 4312A 5207	■		■			■		876	8	160	
	AT 4312A 5401	■		■			■		817	8	160	
	AT 4312C 5101	■				■	■		876	8	160	
C	AT 4312C 51XB	■				■	■		876	8	160	
	AT 4312H 5101	■					■		736	8	160	
H	AT 4312H 51XB	■					■		736	8	160	
ARTICLE ON REQUEST												
	A AT 4312A 5900	■		■			■		782	8	160	
	AT 4312C 5207	■				■	■		981	8	160	
C	AT 4312C 5401	■				■	■		915	8	160	
	AT 4312C 5900	■					■		876	8	160	
	AT 4312H 5207	■					■		824	8	160	
H	AT 4312H 5401	■					■		769	8	160	
	AT 4312H 5900	■					■		736	8	160	



A

Closed bottom
Load capacity 15 kg



C

Reinforced bottom
Load capacity 20 kg



H

Perforated bottom
Load capacity 15 kg



A	
Stacked edge height	109 mm
Usable stacked height / with lid	105 mm/ 107 mm
Usable internal dimensions	355 x 255 x 116 H mm
Volume	10 litres
Pieces per pack / pallet	8 160
Package dimensions	620 x 420 x 467 H mm
Pallet dimensions	1200 x 800 x 2341 H mm
C	
Stacked edge height	109 mm
Usable stacked height / with lid	92 mm/ 96 mm
Usable internal dimensions	355 x 255 x 105 H mm
Volume	10 litres
Pieces per pack / pallet	8 160
Package dimensions	620 x 420 x 467 H mm
Pallet dimensions	1200 x 800 x 2341 H mm
H	
Stacked edge height	109 mm
Usable stacked height / with lid	105 mm/ 107 mm
Usable internal dimensions	355 x 255 x 116 H mm
Volume	10 litres
Pieces per pack / pallet	8 160
Package dimensions	620 x 420 x 467 H mm
Pallet dimensions	1200 x 800 x 2341 H mm

ARTICLES ON REQUEST

Minimum order200 pieces
Delivery guaranteed within.....6 weeks

400 x 300 mm H 120 mm

	ARTICLE	SEPARATE LID	HINGED LID	SLIDING LID	GR.	PACKAGING		UNIT PRICE €	
						Qty. per pack.	Qty. per pallet		
1	AT 43SE 5101	■			322	10	480		♻️
	AT 43SE 51XB	■			322	10	480		♻️
	AT 43SE 5207	■			361	10	480		♻️
2	AT 43HG 5101		■		340	10	640		♻️
	AT 43HG 51XB		■		340	10	640		♻️
	AT 43HG 5207		■		381	10	640		♻️
	AT 43HG 5401		■		355	10	640		♻️
	AT 43HG 5900		■		340	10	640		♻️
3	AT 43SL 5101			■	328	10	480		♻️
	AT 43SL 51XB			■	328	10	480		♻️
	AT 43SL 5207			■	367	10	480		♻️
4	SPRING 0099	Document holder spring				10			
5	AT LOCK 8113	Pair closing clips				10			
ARTICLE ON REQUEST									
1	AT 43SE 5401	■			336	10	480		♻️
	AT 43SE 5900	■			322	10	480		♻️
3	AT 43SL 5900			■	328	10	480		♻️



1



2



3



4



5



DATASHEET

1	
Separate lid	400 x 300 mm
Pieces per pack./dimension	10 / 400 x 300 x 100 H mm
Pieces per pallet / dimension	480 / 1200 x 800 x 1000 H mm
2	
Hinged lid	400 x 300 mm
Pieces per pack./dimension	10 / 400 x 300 x 100 H mm
Pieces per pallet / dimension	640 / 1200 x 800 x 1000 H mm
3	
Sliding lid	400 x 300 mm
Pieces per pack./dimension	10 / 400 x 300 x 100 H mm
Pieces per pallet / dimension	480 / 1200 x 800 x 1000 H mm
4	
Document holder spring	
Pieces per pack	10
5	
Pair closing clips	
Pieces per pack	10

iMilani srl reserves the right to alter the characteristics of products without notice. The values shown are nominal, with a +/- 1% tolerance for size, depending on the material, and a +/- 3% for weight.

	ARTICLE	WALLS		BOTTOM			HANDLES		GR.	PACKAGING		UNIT PRICE €
		Closed	Perforated	Closed	Perforated	Reinforced	Closed	Open		Qty. per pack.	Qty. per pallet	
	AT 4317A 5101	■		■			■		1042	6	112	
	AT 4317A 51XB	■		■			■		1042	6	112	
A	AT 4317A 5207	■		■			■		1167	6	112	
	AT 4317A 5401	■		■			■		1089	6	112	
	AT 4317C 5101	■				■	■		1108	6	112	
C	AT 4317C 51XB	■				■	■		1108	6	112	
ARTICLE ON REQUEST												
	A AT 4317A 5900	■		■			■		1042	6	112	
	AT 4317C 5207	■				■	■		1241	6	112	
C	AT 4317C 5401	■				■	■		1158	6	112	
	AT 4317C 5900	■				■	■		1108	6	112	



ECOGREEN



ECOGREEN



A

Closed bottom
Load capacity 15 kg



C

Reinforced bottom
Load capacity 20 kg



A

Stacked edge height	159 mm
Usable stacked height / with lid	155 mm/ 157 mm
Usable internal dimensions	355 x 255 x 166 H mm
Volume	15 litres
Pieces per pack / pallet	6 112
Package dimensions	620 x 420 x 508 H mm
Pallet dimensions	1200 x 800 x 2387 H mm

C

Stacked edge height	159 mm
Usable stacked height / with lid	142 mm/ 146 mm
Usable internal dimensions	355 x 255 x 155 H mm
Volume	15 litres
Pieces per pack / pallet	6 112
Package dimensions	620 x 420 x 508 H mm
Pallet dimensions	1200 x 800 x 2387 H mm

DATASHEET

ARTICLES ON REQUEST

Minimum order200 pieces
Delivery guaranteed within.....6 weeks

ARTICLE	WALLS		BOTTOM			HANDLES		GR.	PACKAGING		UNIT PRICE €
	Closed	Perforated	Closed	Perforated	Reinforced	Closed	Open		Qty. per pack.	Qty. per pallet	
AT 4322A 5101	■		■			■		1284	4	80	
AT 4322A 51XB	■		■			■		1284	4	80	
AT 4322A 5207	■		■			■		1438	4	80	
AT 4322A 5401	■		■			■		1342	4	80	
AT 4322B 5101	■		■				■	1230	4	80	
AT 4322B 51XB	■		■				■	1230	4	80	
AT 4322D 5101	■				■		■	1330	4	80	
AT 4322D 51XB	■				■		■	1330	4	80	
ARTICLE ON REQUEST											
A AT 4322A 5900	■		■			■		1284	4	80	
AT 4322B 5207	■		■				■	1378	4	80	
B AT 4322B 5900	■		■				■	1230	4	80	
AT 4322D 5207	■				■		■	1490	4	80	
D AT 4322D 5900	■				■		■	1230	4	80	



ECOGREEN



A

Closed bottom
Load capacity 15 kg



B

Closed bottom
Load capacity 15 kg



D

Reinforced bottom
Load capacity 20 kg



A	
Stacked edge height	209 mm
Usable stacked height / with lid	205 mm/ 207 mm
Usable internal dimensions	355 x 255 x 216 H mm
Volume	20 litres
Pieces per pack / pallet	4 80
Package dimensions	620 x 420 x 449 H mm
Pallet dimensions	1200 x 800 x 2251 H mm
B	
Stacked edge height	209 mm
Usable stacked height / with lid	205 mm/ 207 mm
Usable internal dimensions	355 x 255 x 216 H mm
Volume	20 litres
Pieces per pack / pallet	4 80
Package dimensions	620 x 420 x 449 H mm
Pallet dimensions	1200 x 800 x 2251 H mm
D	
Stacked edge height	209 mm
Usable stacked height / with lid	192 mm/ 196 mm
Usable internal dimensions	355 x 255 x 205 H mm
Volume	20 litres
Pieces per pack / pallet	4 80
Package dimensions	620 x 420 x 449 H mm
Pallet dimensions	1200 x 800 x 2251 H mm

DATASHEET

ARTICLES ON REQUEST

Minimum order200 pieces
Delivery guaranteed within.....6 weeks

400 x 300 mm H 220 mm

	ARTICLE	SEPARATE LID	HINGED LID	SLIDING LID	GR.	PACKAGING		UNIT PRICE €	
						Qty. per pack.	Qty. per pallet		
1	AT 43SE 5101	■			322	10	480		
	AT 43SE 51XB	■			322	10	480		
	AT 43SE 5207	■			361	10	480		
2	AT 43HG 5101		■		340	10	640		
	AT 43HG 51XB		■		340	10	640		
	AT 43HG 5207		■		381	10	640		
	AT 43HG 5401		■		355	10	640		
	AT 43HG 5900		■		340	10	640		
3	AT 43SL 5101			■	328	10	480		
	AT 43SL 51XB			■	328	10	480		
	AT 43SL 5207			■	367	10	480		
4	SPRING 0099	Document holder spring				10			
5	AT LOCK 8113	Pair closing clips				10			
6	AT LH43 5107	Label holders				10			
7	LB 14581 0425	A4 sheet with 4 labels				25			
ARTICLE ON REQUEST									
1	AT 43SE 5401	■			336	10	480		
	AT 43SE 5900	■			322	10	480		
3	AT 43SL 5900			■	328	10	480		

1	Separate lid	400 x 300 mm
	Pieces per pack. / dimens.	10 / 400 x 300 x 100 H mm
	Pieces per pallet / dimens.	480 / 1200 x 800 x 1000 H mm
2	Hinged lid	400 x 300 mm
	Pieces per pack. / dimens.	10 / 400 x 300 x 100 H mm
	Pieces per pallet / dimens.	640 / 1200 x 800 x 1000 H mm
3	Sliding lid	400 x 300 mm
	Pieces per pack. / dimens.	10 / 400 x 300 x 100 H mm
	Pieces per pallet / dimens.	480 / 1200 x 800 x 1000 H mm
4	Document holder spring	
	Pieces per pack	10
5	Pair closing clips	
	Pieces per pack	10
6	Label holders	150 x 85 H mm
	Pieces per pack	10
7	A4 sheet with 4 labels	145 x 81 mm
	Pieces per pack	25



ARTICLE	WALLS		BOTTOM			HANDLES		GR.	PACKAGING		UNIT PRICE €
	Closed	Perforated	Closed	Perforated	Reinforced	Closed	Open		Qty. per pack.	Qty. per pallet	
AT 4332A 5101	■		■			■		1852	2	56	
AT 4332A 51XB	■		■			■		1852	2	56	
AT 4332A 5207	■		■			■		2074	2	56	
AT 4332A 5401	■		■			■		1935	2	56	
AT 4332B 5101	■		■				■	1728	2	56	
AT 4332B 51XB	■		■				■	1728	2	56	
ARTICLE ON REQUEST											
A AT 4332A 5900	■		■			■		1852	2	56	
B AT 4332B 5207	■		■				■	1935	2	56	
B AT 4332B 5900	■		■				■	1728	2	56	



ECOGREEN



A

Closed bottom
Load capacity 15 kg



B

Closed bottom
Load capacity 15 kg



A

Stacked edge height	314 mm
Usable stacked height / with lid	310 mm/ 312 mm
Usable internal dimensions	355 x 255 x 321 H mm
Volume	30 litres
Pieces per pack / pallet	2 56
Package dimensions	620 x 420 x 345 H mm
Pallet dimensions	1200 x 800 x 2359 H mm

B

Stacked edge height	314 mm
Usable stacked height / with lid	310 mm/ 312 mm
Usable internal dimensions	355 x 255 x 321 H mm
Volume	30 litres
Pieces per pack / pallet	2 56
Package dimensions	620 x 420 x 345 H mm
Pallet dimensions	1200 x 800 x 2359 H mm

DATASHEET

400 x 300 mm H 325 mm

	ARTICLE	SEPARATE LID	HINGED LID	SLIDING LID	GR.	PACKAGING		UNIT PRICE €	
						Qty. per pack.	Qty. per pallet		
1	AT 43SE 5101	■			322	10	480		
	AT 43SE 51XB	■			322	10	480		
	AT 43SE 5207	■			361	10	480		
2	AT 43HG 5101		■		340	10	640		
	AT 43HG 51XB		■		340	10	640		
	AT 43HG 5207		■		381	10	640		
	AT 43HG 5401		■		355	10	640		
	AT 43HG 5900		■		340	10	640		
3	AT 43SL 5101			■	328	10	480		
	AT 43SL 51XB			■	328	10	480		
	AT 43SL 5207			■	368	10	480		
4	SPRING 0099	Document holder spring				10			
5	AT LOCK 8113	Pair closing clips				10			
6	AT LH43 5107	Label holders				10			
7	LB 14581 0425	A4 sheet with 4 labels				25			
ARTICLE ON REQUEST									
1	AT 43SE 5401	■			337	10	480		
	AT 43SE 5900	■			322	10	480		
3	AT 43SL 5900			■	328	10	480		

DATASHEET

Separate lid	400 x 300 mm
1 Pieces per pack. / dimens.	10 / 400 x 300 x 100 H mm
Pieces per pallet / dimens.	480 / 1200 x 800 x 1000 H mm
Hinged lid	400 x 300 mm
2 Pieces per pack. / dimens.	10 / 400 x 300 x 100 H mm
Pieces per pallet / dimens.	640 / 1200 x 800 x 1000 H mm
Sliding lid	400 x 300 mm
3 Pieces per pack. / dimens.	10 / 400 x 300 x 100 H mm
Pieces per pallet / dimens.	480 / 1200 x 800 x 1000 H mm
Document holder spring	
4 Pieces per pack	10
Pair closing clips	
5 Pieces per pack	10
Label holders	150 x 85 H mm
6 Pieces per pack	10
A4 sheet with 4 labels	145 x 81 mm
7 Pieces per pack	25



	ARTICLE	1 PARTITION	2 PARTITIONS	4 PARTITIONS	GR.	PACKAGING		UNIT PRICE €
						Qty. per pack.	Qty. per pallet	
1	AT 43S1 5207	■			246	20	320	
	AT 43S1 5407	■			230	20	320	
2	AT 43S2 5207		■		263	20	320	
	AT 43S2 5407		■		246	20	320	
3	AT 43S4 5207			■	291	20	320	
	AT 43S4 5407			■	272	20	320	
4	AT LID4 6896	Transparent lid			118	20		

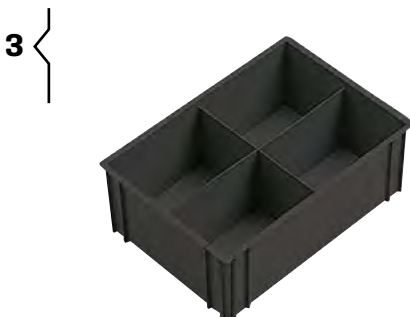

Subdivision with 1 and 2 compartments



Subdivision with 1 and 4 compartments



Subdivision with 2 and 4 compartments

1

Partitioned box 1 partition	256 x 178 x 90 H mm	
Pieces per pack / pallet	📦 20	🚚 320
Package dimensions	565 x 375 x 460 H mm	
Pallet dimensions	1200 x 800 x 1990 H mm	

2

Partitioned box 2 partitions	256 x 178 x 90 H mm	
Pieces per pack / pallet	📦 20	🚚 320
Package dimensions	565 x 375 x 460 H mm	
Pallet dimensions	1200 x 800 x 1990 H mm	

3

Partitioned box 4 partitions	256 x 178 x 90 H mm	
Pieces per pack / pallet	📦 20	🚚 320
Package dimensions	565 x 375 x 460 H mm	
Pallet dimensions	1200 x 800 x 1990 H mm	

4

Transparent polystyrene lid		
Pieces per pack / pallet	📦 20	
Package dimensions	265 x 195 x 180 H mm	

400 x 300 mm

	ARTICLE	H 45	H 70	H 90	H 120	H 180	GR.	PACKAGING		UNIT PRICE €
								Qty. per pack.	Qty. per pallet	
1	DI 25545 5101	■						10		
	DI 25545 5207	■						10		▲
	DI 35545 5101	■						10		
	DI 35545 5207	■						10		▲
2	DI 25570 5101		■					10		
	DI 25570 5207		■					10		▲
	DI 35570 5101		■					10		
	DI 35570 5207		■					10		▲
3	DI 25590 5101			■				10		
	DI 25590 5207			■				10		▲
	DI 35590 5101			■				10		
	DI 35590 5207			■				10		▲
4	DI 25512 5101				■			10		
	DI 25512 5207				■			10		▲
	DI 35512 5101				■			10		
	DI 35512 5207				■			10		▲
5	DI 25518 5101					■		10		
	DI 25518 5207					■		10		▲
	DI 35518 5101					■		10		
	DI 35518 5207					■		10		▲
6	DI 43SHT 5101							10		
	DI 43SHT 5207							10		▲

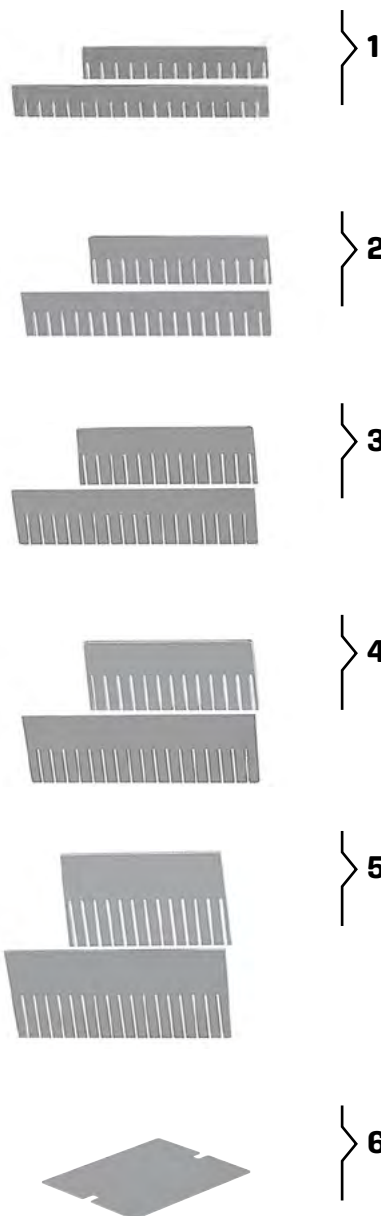

DATASHEET

1	
Comb divider 255 x 45 H mm per box 400 x 300 x 75H mm	10 items
Comb divider 355 x 45 H mm per box 400 x 300 x 75H mm	10 items
2	
Comb divider 255 x 70 H mm per box 400 x 300 x 120H mm	10 items
Comb divider 355 x 70 H mm per box 400 x 300 x 120H mm	10 items
3	
Comb divider 255 x 90 H mm per box 400 x 300 x 120H mm	10 items
Comb divider 355 x 90 H mm per box 400 x 300 x 120H mm	10 items
4	
Comb divider 255 x 120 H mm per box 400 x 300 x 170H mm	10 items
Comb divider 355 x 120 H mm per box 400 x 300 x 170H mm	10 items
5	
Comb divider 255 x 180 H mm per box 400 x 300 x 220H mm	10 items
Comb divider 355 x 180 H mm per box 400 x 300 x 220H mm	10 items
6	
Intermediate partition shelf 355 x 255 mm	10 items

ARTICLE	WALLS		BOTTOM			HANDLES		GR.	PACKAGING		UNIT PRICE €
	Closed	Perforated	Closed	Perforated	Reinforced	Closed	Open		Qty. per pack.	Qty. per pallet	
AT 6408A 5101	■		■			■		1312	7	140	
AT 6408A 51XB	■		■			■		1312	7	140	
A AT 6408A 5207	■		■			■		1469	7	140	
AT 6408A 5401	■		■			■		1371	7	140	
AT 6408A 5900	■		■			■		1312	7	140	



ECOGREEN



A

Closed bottom
Load capacity 20 kg



A

Stacked edge height	64 mm
Usable stacked height / with lid	60 mm/ 62 mm
Usable internal dimensions	555 x 355 x 71 H mm
Volume	10 litres
Pieces per pack / pallet	7 140
Package dimensions	620 x 420 x 479 H mm
Pallet dimensions	1200 x 800 x 2401 H mm

DATASHEET

600 x 400 mm H 75 mm

	ARTICLE	SEPARATE LID	HINGED LID	GR.	PACKAGING		UNIT PRICE €
					Qty. per pack.	Qty. per pallet	
1	AT 64SE 5101	■		720	10	240	
	AT 64SE 51XB	■		720	10	240	
	AT 64SE 5207	■		806	10	240	
2	AT 64HG 5101		■	700	10	320	
	AT 64HG 51XB		■	700	10	320	
	AT 64HG 5207		■	784	10	320	
	AT 64HG 5401		■	732	10	320	
	AT 64HG 5900		■	700	10	320	
3	SPRING 0099	Document holder spring			10		
4	AT LOCK 8113	Pair closing clips			10		
ARTICLE ON REQUEST							
1	AT 64SE 5401	■		752	10	240	
	AT 64SE 5900	■		720	10	240	













DATASHEET

1	
Separate lid	600 x 400 mm
Pieces per pack. / dimens.	10 / 600 x 400 x 100 H mm
Pieces per pallet / dimens.	240 / 1200 x 800 x 1000 H mm
2	
Hinged lid	600 x 400 mm
Pieces per pack. / dimens.	10 / 600 x 400 x 100 H mm
Pieces per pallet / dimens.	320 / 1200 x 800 x 1000 H m
3	
Document holder spring	
Pieces per pack	10
4	
Pair closing clips	
Pieces per pack	10

iMilani srl reserves the right to alter the characteristics of products without notice. The values shown are nominal, with a +/- 1% tolerance for size, depending on the material, and a +/- 3% for weight.

innovative
italian
ideas

iMilani

ARTICLE	WALLS		BOTTOM			HANDLES		GR.	PACKAGING		UNIT PRICE €
	Closed	Perforated	Closed	Perforated	Reinforced	Closed	Open		Qty. per pack.	Qty. per pallet	
 AT 6412A 5101	■		■			■		1636	4	80	
 AT 6412A 51XB	■		■			■		1636	4	80	
 A AT 6412A 5207	■		■			■		1832	4	80	
 AT 6412A 5401	■		■			■		1710	4	80	
 AT 6412A 5900	■		■			■		1636	4	80	
 AT 6412C 5101	■				■	■		1690	4	80	
 AT 6412C 51XB	■				■	■		1690	4	80	
 C AT 6412C 5207	■				■	■		1893	4	80	
 AT 6412C 5401	■				■	■		1766	4	80	
 AT 6412C 5900	■				■	■		1690	4	80	

A

Closed bottom
Load capacity 20 kg



C



Reinforced bottom
Load capacity 30 kg



A

Stacked edge height	109 mm
Usable stacked height / with lid	105 mm/ 107 mm
Usable internal dimensions	555 x 355 x 116 H mm
Volume	20 litres
Pieces per pack / pallet	 4  80
Package dimensions	620 x 420 x 467 H mm
Pallet dimensions	1200 x 800 x 2341 H mm

C

Stacked edge height	109 mm
Usable stacked height / with lid	92 mm/ 96 mm
Usable internal dimensions	555 x 355 x 105 H mm
Volume	20 litres
Pieces per pack / pallet	 4  80
Package dimensions	620 x 420 x 467 H mm
Pallet dimensions	1200 x 800 x 2341 H mm

600 x 400 mm H 120 mm

	ARTICLE	SEPARATE LID	HINGED LID	GR.	PACKAGING		UNIT PRICE €	
					Qty. per pack.	Qty. per pallet		
1	AT 64SE 5101	■		720	10	240		♻️ PP
	AT 64SE 51XB	■		720	10	240		♻️ PP
	AT 64SE 5207	■		806	10	240		♻️ PP
2	AT 64HG 5101		■	700	10	320		♻️ PP
	AT 64HG 51XB		■	700	10	320		♻️ PP
	AT 64HG 5207		■	784	10	320		♻️ PP
	AT 64HG 5401		■	732	10	320		♻️ PP ECOGREEN
	AT 64HG 5900		■	700	10	320		♻️ PP ♻️ ♻️
3	SPRING 0099	Document holder spring				10		
4	AT LOCK 8113	Pair closing clips				10		
ARTICLE ON REQUEST								
1	AT 64SE 5401	■		752	10	240		♻️ PP ECOGREEN
	AT 64SE 5900	■		720	10	240		♻️ PP ♻️ ♻️



DATASHEET

1	
Separate lid	600 x 400 mm
Pieces per pack. / dimens.	♻️ 10 / 600 x 400 x 100 H mm
Pieces per pallet / dimens.	♻️ 240 / 1200 x 800 x 1000 H mm
2	
Hinged lid	600 x 400 mm
Pieces per pack. / dimens.	♻️ 10 / 600 x 400 x 100 H mm
Pieces per pallet / dimens.	♻️ 320 / 1200 x 800 x 1000 H mm
3	
Document holder spring	
Pieces per pack	♻️ 10
4	
Pair closing clips	
Pieces per pack	♻️ 10

iMilani srl reserves the right to alter the characteristics of products without notice. The values shown are nominal, with a +/- 1% tolerance for size, depending on the material, and a +/- 3% for weight.

ARTICLE	WALLS		BOTTOM			HANDLES		GR.	PACKAGING		UNIT PRICE €
	Closed	Perforated	Closed	Perforated	Reinforced	Closed	Open		Qty. per pack.	Qty. per pallet	
AT 6412G 5101	■		■			■		1624	4	80	
AT 6412G 51XB	■		■			■		1624	4	80	
AT 6412G 5207	■		■			■		1819	4	80	
AT 6412G 5401	■		■			■		1697	4	80	
AT 6412G 5900	■		■			■		1624	4	80	
AT 6412H 5101	■			■		■		1460	4	80	
AT 6412H 51XB	■			■		■		1460	4	80	
AT 6412H 5207	■			■		■		1635	4	80	
AT 6412H 5401	■			■		■		1526	4	80	
AT 6412H 5900	■			■		■		1460	4	80	



ECOGREEN



ECOGREEN



G

Closed bottom
Load capacity 20 kg



H

Perforated bottom
Load capacity 15 kg



G

Stacked edge height	109 mm
Usable stacked height / with lid	105 mm / 107 mm
Usable internal dimensions	555 x 355 x 116 H mm
Volume	20 litres
Pieces per pack / pallet	4 80
Package dimensions	620 x 420 x 467 H mm
Pallet dimensions	1200 x 800 x 2341 H mm

H

Stacked edge height	109 mm
Usable stacked height / with lid	105 mm / 107 mm
Usable internal dimensions	555 x 355 x 116 H mm
Volume	20 litres
Pieces per pack / pallet	4 80
Package dimensions	620 x 420 x 467 H mm
Pallet dimensions	1200 x 800 x 2341 H mm

DATASHEET

<< CONTINUED ON PREVIOUS PAGE

600 x 400 mm H 120 mm

	ARTICLE	SEPARATE LID	HINGED LID	GR.	PACKAGING		UNIT PRICE €	
					Qty. per pack.	Qty. per pallet		
1	AT 64SE 5101	■		720	10	240		♻️ PP
	AT 64SE 51XB	■		720	10	240		♻️ PP
	AT 64SE 5207	■		806	10	240		♻️ PP
2	AT 64HG 5101		■	700	10	320		♻️ PP
	AT 64HG 51XB		■	700	10	320		♻️ PP
	AT 64HG 5207		■	784	10	320		♻️ PP
	AT 64HG 5401		■	732	10	320		♻️ PP ECOGREEN
	AT 64HG 5900		■	700	10	320		♻️ PP ♻️ ♻️
3	SPRING 0099	Document holder spring			10			
4	AT LOCK 8113	Pair closing clips			10			
ARTICLE ON REQUEST								
1	AT 64SE 5401	■		752	10	240		♻️ PP ECOGREEN
	AT 64SE 5900	■		720	10	240		♻️ PP ♻️ ♻️



DATASHEET

1	
Separate lid	600 x 400 mm
Pieces per pack. / dimens.	♻️ 10 / 600 x 400 x 100 H mm
Pieces per pallet / dimens.	♻️ 240 / 1200 x 800 x 1000 H mm
2	
Hinged lid	600 x 400 mm
Pieces per pack. / dimens.	♻️ 10 / 600 x 400 x 100 H mm
Pieces per pallet / dimens.	♻️ 320 / 1200 x 800 x 1000 H m
3	
Document holder spring	
Pieces per pack	♻️ 10
4	
Pair closing clips	
Pieces per pack	♻️ 10

iMilani srl reserves the right to alter the characteristics of products without notice. The values shown are nominal, with a +/- 1% tolerance for size, depending on the material, and a +/- 3% for weight.

	ARTICLE	WALLS		BOTTOM			HANDLES		GR.	PACKAGING		UNIT PRICE €
		Closed	Perforated	Closed	Perforated	Reinforced	Closed	Open		Qty. per pack.	Qty. per pallet	
A	AT 6417A 5101	■		■			■		2134	3	56	
	AT 6417A 51XB	■		■			■		2134	3	56	
	AT 6417A 5207	■		■			■		2390	3	56	
C	AT 6417C 5101	■				■	■		2266	3	56	
	AT 6417C 51XB	■				■	■		2266	3	56	
	ARTICLE ON REQUEST											
A	AT 6417A 5900	■		■			■		2134	3	56	
	AT 6417C 5207	■				■	■		2538	3	56	
	AT 6417C 5401	■				■	■		2368	3	56	
	AT 6417C 5900	■				■	■		2266	3	56	



ECOGREEN



ECOGREEN



A

Closed bottom
Load capacity 20 kg



C

Reinforced bottom
Load capacity 30 kg



A

Stacked edge height	159 mm
Usable stacked height / with lid	155 mm/ 157 mm
Usable internal dimensions	555 x 355 x 166 H mm
Volume	30 litres
Pieces per pack / pallet	3 56
Package dimensions	620 x 420 x 508 H mm
Pallet dimensions	1200 x 800 x 2387 H mm

C

Stacked edge height	159 mm
Usable stacked height / with lid	142 mm/ 146 mm
Usable internal dimensions	555 x 355 x 155 H mm
Volume	30 litres
Pieces per pack / pallet	3 56
Package dimensions	620 x 420 x 508 H mm
Pallet dimensions	1200 x 800 x 2387 H mm

DATASHEET

600 x 400 mm H 170 mm

	ARTICLE	SEPARATE LID	HINGED LID	GR.	PACKAGING		UNIT PRICE €	
					Qty. per pack.	Qty. per pallet		
1	AT 64SE 5101	■		720	10	240		
	AT 64SE 51XB	■		720	10	240		
	AT 64SE 5207	■		806	10	240		
2	AT 64HG 5101		■	700	10	320		
	AT 64HG 51XB		■	700	10	320		
	AT 64HG 5207		■	784	10	320		
	AT 64HG 5401		■	732	10	320		
	AT 64HG 5900		■	700	10	320		
3	SPRING 0099	Document holder spring			10			
4	AT LOCK 8113	Pair closing clips			10			
5	AT LH64 5107	Label holders			10			
6	LB 21081 0325	A4 sheet with 3 labels			25			
7	AT DI17 0199	Galvanised divider with pair of supports			1			
ARTICLE ON REQUEST								
1	AT 64SE 5401	■		752	10	240		
	AT 64SE 5900	■		720	10	240		

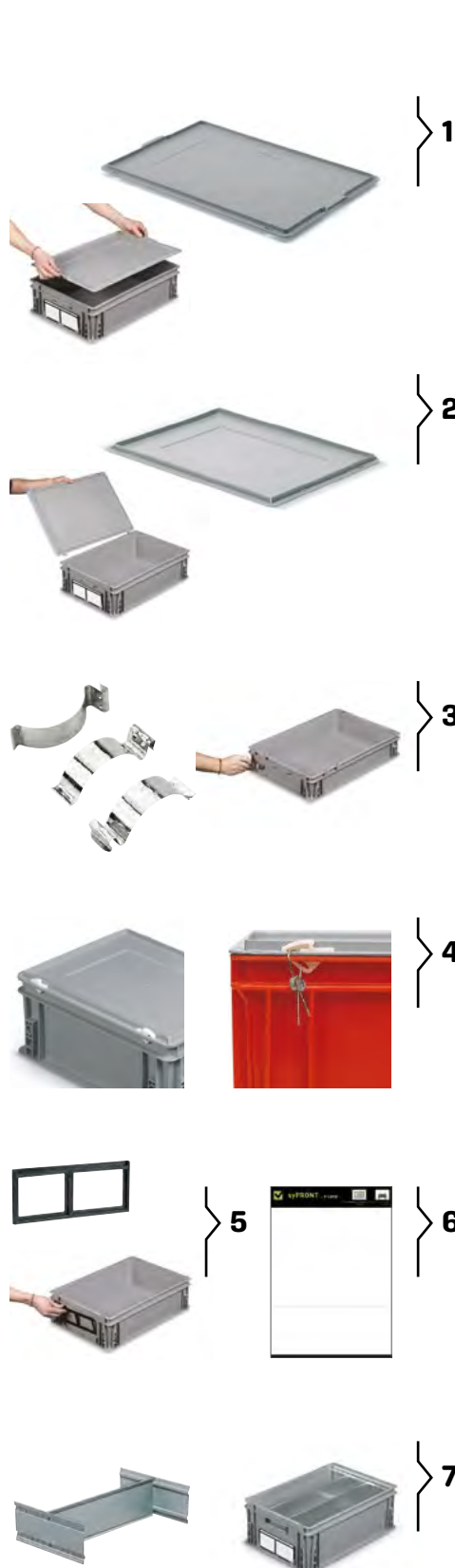

DATASHEET

Separate lid	600 x 400 mm
1 Pieces per pack. / dimens.	10 / 400 x 300 x 100 H mm
Pieces per pallet / dimens.	240 / 1200 x 800 x 1000 H mm
Hinged lid	600 x 400 mm
2 Pieces per pack. / dimens.	10 / 400 x 300 x 100 H mm
Pieces per pallet / dimens.	320 / 1200 x 800 x 1000 H mm
Document holder spring	
3 Pieces per pack	10
Pair closing clips	
4 Pieces per pack	10
Label holders	215 x 85 H mm
5 Pieces per pack	10
A4 sheet with 3 labels	210 x 81 H mm
6 Pieces per pack	25
Galv. divider w/pair of supports	145 H mm
7 Pieces per pack	1

	ARTICLE	WALLS		BOTTOM			HANDLES		GR.	PACKAGING		UNIT PRICE €
		Closed	Perforated	Closed	Perforated	Reinforced	Closed	Open		Qty. per pack.	Qty. per pallet	
	AT 6422A 5101	■		■			■		2586	2	40	
A	AT 6422A 51XB	■		■			■		2586	2	40	
	AT 6422A 5401	■		■			■		2702	2	40	
	AT 6422B 5101	■		■				■	2518	2	40	
B	AT 6422B 51XB	■		■				■	2518	2	40	
ARTICLE ON REQUEST												
	AT 6422A 5207	■		■			■		2896	2	40	
A	AT 6422A 5900	■		■			■		2586	2	40	
	AT 6422B 5207	■		■				■	2820	2	40	
B	AT 6422B 5900	■		■				■	2518	2	40	



A

Closed bottom
Load capacity 20 kg



B

Closed bottom
Load capacity 20 kg



A

Stacked edge height	209 mm
Usable stacked height / with lid	205 mm/ 207 mm
Usable internal dimensions	555 x 355 x 216 H mm
Volume	40 litres
Pieces per pack / pallet	2 40
Package dimensions	620 x 420 x 449 H mm
Pallet dimensions	1200 x 800 x 2251 H mm

B

Stacked edge height	209 mm
Usable stacked height / with lid	205 mm/ 207 mm
Usable internal dimensions	555 x 355 x 216 H mm
Volume	40 litres
Pieces per pack / pallet	2 40
Package dimensions	620 x 420 x 449 H mm
Pallet dimensions	1200 x 800 x 2251 H mm

DATASHEET

CONTINUED ON NEXT PAGE



ARTICLES ON REQUEST

Minimum order200 pieces
Delivery guaranteed within.....6 weeks

600 x 400 mm H 220 mm

	ARTICLE	SEPARATE LID	HINGED LID	GR.	PACKAGING		UNIT PRICE €	
					Qty. per pack.	Qty. per pallet		
1	AT 64SE 5101	■		720	10	240		
	AT 64SE 51XB	■		720	10	240		
	AT 64SE 5207	■		806	10	240		
2	AT 64HG 5101		■	700	10	320		
	AT 64HG 51XB		■	700	10	320		
	AT 64HG 5207		■	784	10	320		
	AT 64HG 5401		■	732	10	320		
	AT 64HG 5900		■	700	10	320		
3	SPRING 0099	Document holder spring			10			
4	AT LOCK 8113	Pair closing clips			10			
5	AT LH64 5107	Label holders			10			
6	LB 21081 0325	A4 sheet with 3 labels			25			
7	AT DI22 0199	Galvanised divider with pair of supports			1			
ARTICLE ON REQUEST								
1	AT 64SE 5401	■		752	10	240		
	AT 64SE 5900	■		720	10	240		

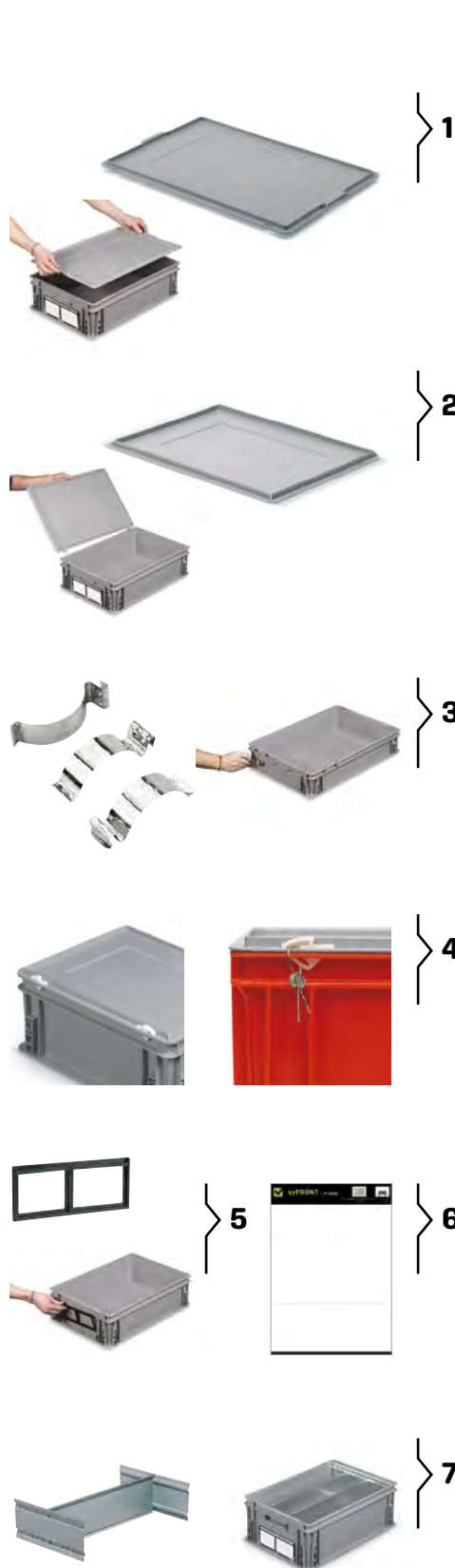

DATASHEET

Separate lid	600 x 400 mm
1 Pieces per pack. / dimens.	10 / 600 x 400 x 100 H mm
Pieces per pallet / dimens.	240 / 1200 x 800 x 1000 H mm
Hinged lid	600 x 400 mm
2 Pieces per pack. / dimens.	10 / 600 x 400 x 100 H mm
Pieces per pallet / dimens.	320 / 1200 x 800 x 1000 H mm
Document holder spring	
3 Pieces per pack	10
Pair closing clips	
4 Pieces per pack	10
Label holders	215 x 85 H mm
5 Pieces per pack	10
A4 sheet with 3 labels	210 x 81 H mm
6 Pieces per pack	25
Galv. divider w/pair of supports	195 H mm
7 Pieces per pack	1

	ARTICLE	WALLS		BOTTOM			HANDLES		GR.	PACKAGING		UNIT PRICE €
		Closed	Perforated	Closed	Perforated	Reinforced	Closed	Open		Qty. per pack.	Qty. per pallet	
D	AT 6422D 5101	■				■		■	2800	2	40	
	AT 6422D 51XB	■				■		■	2800	2	40	
S	AT 6422S 5101		■		■			■	2424	2	40	
	AT 6422S 51XB		■		■			■	2424	2	40	
	ARTICLE ON REQUEST											
D	AT 6422D 5207	■				■		■	3136	2	40	
	AT 6422A 5900	■				■		■	2800	2	40	
S	AT 6422S 5207		■		■			■	2715	2	40	
	AT 6422S 5900		■		■			■	2424	2	40	

D

Reinforced bottom
Load capacity 30 kg



S

Perforated bottom
Load capacity 15 kg



D

Stacked edge height	209 mm
Usable stacked height / with lid	192 mm/ 196 mm
Usable internal dimensions	555 x 355 x 205 H mm
Volume	40 litres
Pieces per pack / pallet	2 40
Package dimensions	620 x 420 x 449 H mm
Pallet dimensions	1200 x 800 x 2251 H mm

S

Stacked edge height	209 mm
Usable stacked height / with lid	205 mm/ 207 mm
Usable internal dimensions	555 x 355 x 216 H mm
Volume	40 litres
Pieces per pack / pallet	2 40
Package dimensions	620 x 420 x 449 H mm
Pallet dimensions	1200 x 800 x 2251 H mm

DATASHEET

<< CONTINUED ON PREVIOUS PAGE

ARTICLES ON REQUEST

Minimum order200 pieces
Delivery guaranteed within.....6 weeks

600 x 400 mm H 220 mm

	ARTICLE	SEPARATE LID	HINGED LID	GR.	PACKAGING		UNIT PRICE €	
					Qty. per pack.	Qty. per pallet		
1	AT 64SE 5101	■		720	10	240		♻️
	AT 64SE 51XB	■		720	10	240		♻️
	AT 64SE 5207	■		806	10	240		♻️
2	AT 64HG 5101		■	700	10	320		♻️
	AT 64HG 51XB		■	700	10	320		♻️
	AT 64HG 5207		■	784	10	320		♻️
	AT 64HG 5401		■	732	10	320		♻️
	AT 64HG 5900		■	700	10	320		♻️
3	SPRING 0099	Document holder spring			10			
4	AT LOCK 8113	Pair closing clips			10			
5	AT LH64 5107	Label holders			10			
6	LB 21081 0325	A4 sheet with 3 labels			25			
7	AT DI22 0199	Galvanised divider with pair of supports			1			
ARTICLE ON REQUEST								
1	AT 64SE 5401	■		752	10	240		♻️
	AT 64SE 5900	■		720	10	240		♻️



1



2



3



4



5



6



7

DATASHEET

Separate lid	600 x 400 mm
1 Pieces per pack. / dims.	📦 10 / 600 x 400 x 100 H mm
Pieces per pallet / dims.	📦 240 / 1200 x 800 x 1000 H mm
Hinged lid	600 x 400 mm
2 Pieces per pack. / dims.	📦 10 / 600 x 400 x 100 H mm
Pieces per pallet / dims.	📦 320 / 1200 x 800 x 1000 H mm
Document holder spring	
3 Pieces per pack	📦 10
Pair closing clips	
4 Pieces per pack	📦 10
Label holders	215 x 85 H mm
5 Pieces per pack	📦 10
A4 sheet with 3 labels	210 x 81 H mm
6 Pieces per pack	📦 25
Galv. divider w/pair of supports	195 H mm
7 Pieces per pack	📦 1

iMilani srl reserves the right to alter the characteristics of products without notice. The values shown are nominal, with a +/- 1% tolerance for size, depending on the material, and a +/- 3% for weight.

ARTICLE	WALLS		BOTTOM			HANDLES		GR.	PACKAGING		UNIT PRICE €
	Closed	Perforated	Closed	Perforated	Reinforced	Closed	Open		Qty. per pack.	Qty. per pallet	
AT 6428A 5101	■		■			■		2866	2	32	
A AT 6428A 51XB	■		■			■		2866	2	32	
ECOGREEN AT 6428A 5401	■		■			■		2995	2	32	
B AT 6428B 5101	■		■			■		2762	2	32	
B AT 6428B 51XB	■		■			■		2762	2	32	
D AT 6428D 5101	■				■	■		2968	2	32	
D AT 6428D 51XB	■				■	■		2968	2	32	
ARTICLE ON REQUEST											
A AT 6428A 5207	■		■			■		3210	2	32	
AT 6428A 5900	■		■			■		2866	2	32	
B AT 6428B 5207	■		■			■		3093	2	32	
AT 6428B 5900	■		■			■		2762	2	32	
D AT 6428D 5207	■				■	■		3324	2	32	
AT 6428D 5900	■				■	■		2968	2	32	

A

Closed bottom
Load capacity 20 kg



B

Closed bottom
Load capacity 20 kg



D

Reinforced bottom
Load capacity 30 kg



A	
Stacked edge height	269 mm
Usable stacked height / with lid	265 mm/ 267 mm
Usable internal dimensions	555 x 355 x 276 H mm
Volume	53 litres
Pieces per pack / pallet	2 32
Package dimensions	620 x 420 x 569 H mm
Pallet dimensions	1200 x 800 x 2313 H mm
B	
Stacked edge height	269 mm
Usable stacked height / with lid	265 mm/ 267 mm
Usable internal dimensions	555 x 355 x 276 H mm
Volume	53 litres
Pieces per pack / pallet	2 32
Package dimensions	620 x 420 x 569 H mm
Pallet dimensions	1200 x 800 x 2313 H mm
D	
Stacked edge height	269 mm
Usable stacked height / with lid	252 mm/ 256 mm
Usable internal dimensions	555 x 355 x 265 H mm
Volume	53 litres
Pieces per pack / pallet	2 32
Package dimensions	620 x 420 x 569 H mm
Pallet dimensions	1200 x 800 x 2313 H mm

DATASHEET

ARTICLES ON REQUEST

Minimum order200 pieces
Delivery guaranteed within.....6 weeks

600 x 400 mm H 280 mm

	ARTICLE	SEPARATE LID	HINGED LID	GR.	PACKAGING		UNIT PRICE €	
					Qty. per pack.	Qty. per pallet		
1	AT 64SE 5101	■		720	10	240		
	AT 64SE 51XB	■		720	10	240		
	AT 64SE 5207	■		806	10	240		
2	AT 64HG 5101		■	700	10	320		
	AT 64HG 51XB		■	700	10	320		
	AT 64HG 5207		■	784	10	320		
	AT 64HG 5401		■	732	10	320		
	AT 64HG 5900		■	700	10	320		
3	SPRING 0099	Document holder spring			10			
4	AT LOCK 8113	Pair closing clips			10			
5	AT LH64 5107	Label holders			10			
6	LB 21081 0325	A4 sheet with 3 labels			25			
ARTICLE ON REQUEST								
1	AT 64SE 5401	■		752	10	240		
	AT 64SE 5900	■		720	10	240		



DATASHEET

Separate lid	600 x 400 mm
1 Pieces per pack. / dims.	10 / 600 x 400 x 100 H mm
Pieces per pallet / dims.	240 / 1200 x 800 x 1000 H mm
Hinged lid	600 x 400 mm
2 Pieces per pack. / dims.	10 / 600 x 400 x 100 H mm
Pieces per pallet / dims.	320 / 1200 x 800 x 1000 H mm
Document holder spring	
3 Pieces per pack	10
Pair closing clips	
4 Pieces per pack	10
Label holders	215 x 85 H mm
5 Pieces per pack	10
A4 sheet with 3 labels	210 x 81 H mm
6 Pieces per pack	25

iMilani srl reserves the right to alter the characteristics of products without notice. The values shown are nominal, with a +/- 1% tolerance for size, depending on the material, and a +/- 3% for weight.

ARTICLE	WALLS		BOTTOM			HANDLES		GR.	PACKAGING		UNIT PRICE €
	Closed	Perforated	Closed	Perforated	Reinforced	Closed	Open		Qty. per pack.	Qty. per pallet	
AT 6432A 5101	■		■			■		3170	3	40	
AT 6432A 51XB	■		■			■		3170	3	40	
A AT 6432A 5207	■		■			■		3550	3	40	
ECOGREEN AT 6432A 5401	■		■			■		3313	3	40	
AT 6432A 5900	■		■			■		3170	3	40	
B AT 6432B 5101	■		■				■	3228	3	40	
B AT 6432B 51XB	■		■				■	3228	3	40	
ARTICLE ON REQUEST											
B AT 6432B 5207	■		■				■	3615	3	40	
AT 6432B 5900	■		■				■	3228	3	40	

A

Closed bottom
Load capacity 20 kg



B

Closed bottom
Load capacity 20 kg



A

Stacked edge height	314 mm
Usable stacked height / with lid	310 mm / 312 mm
Usable internal dimensions	555 x 355 x 321 H mm
Volume	60 litres
Pieces per pack / pallet	3 40
Package dimensions	620 x 420 x 670 H mm
Pallet dimensions	1200 x 800 x 2410 H mm

B

Stacked edge height	314 mm
Usable stacked height / with lid	310 mm / 312 mm
Usable internal dimensions	555 x 355 x 321 H mm
Volume	60 litres
Pieces per pack / pallet	3 40
Package dimensions	620 x 420 x 670 H mm
Pallet dimensions	1200 x 800 x 2410 H mm

DATASHEET

600 x 400 mm H 325 mm

	ARTICLE	SEPARATE LID	HINGED LID	GR.	PACKAGING		UNIT PRICE €	
					Qty. per pack.	Qty. per pallet		
1	AT 64SE 5101	■		720	10	240		
	AT 64SE 51XB	■		720	10	240		
	AT 64SE 5207	■		806	10	240		
2	AT 64HG 5101		■	700	10	320		
	AT 64HG 51XB		■	700	10	320		
	AT 64HG 5207		■	784	10	320		
	AT 64HG 5401		■	732	10	320		
	AT 64HG 5900		■	700	10	320		
3	SPRING 0099	Document holder spring			10			
4	AT LOCK 8113	Pair closing clips			10			
5	AT LH64 5107	Label holders			10			
6	LB 21081 0325	A4 sheet with 3 labels			25			
ARTICLE ON REQUEST								
1	AT 64SE 5401	■		752	10	240		
	AT 64SE 5900	■		720	10	240		



DATASHEET

Separate lid	600 x 400 mm
1 Pieces per pack. / dims.	10 / 600 x 400 x 100 H mm
Pieces per pallet / dims.	240 / 1200 x 800 x 1000 H mm
Hinged lid	600 x 400 mm
2 Pieces per pack. / dims.	10 / 600 x 400 x 100 H mm
Pieces per pallet / dims.	320 / 1200 x 800 x 1000 H mm
Document holder spring	
3 Pieces per pack	10
Pair closing clips	
4 Pieces per pack	10
Label holders	215 x 85 H mm
5 Pieces per pack	10
A4 sheet with 3 labels	210 x 81 H mm
6 Pieces per pack	25

iMilani srl reserves the right to alter the characteristics of products without notice. The values shown are nominal, with a +/- 1% tolerance for size, depending on the material, and a +/- 3% for weight.

	ARTICLE	WALLS		BOTTOM			HANDLES		GR.	PACKAGING		UNIT PRICE €
		Closed	Perforated	Closed	Perforated	Reinforced	Closed	Open		Qty. per pack.	Qty. per pallet	
D	AT 6432D 5101	■				■		■	3500	3	40	
	AT 6432D 51XB	■				■		■	3500	3	40	
R	AT 6432R 5101		■	■				■	2968	3	40	
	AT 6432R 51XB		■	■				■	2968	3	40	
ARTICLE ON REQUEST												
D	AT 6432D 5207	■				■		■	3920	3	40	
	AT 6432D 5900	■				■		■	3500	3	40	
R	AT 6432R 5207		■	■				■	3324	3	40	
	AT 6432R 5900		■	■				■	2968	3	40	

D

Reinforced bottom
Load capacity 30 kg



R

Closed bottom
Load capacity 20 kg



D

Stacked edge height	314 mm
Usable stacked height / with lid	297 mm/ 301 mm
Usable internal dimensions	555 x 355 x 310 H mm
Volume	60 litres
Pieces per pack / pallet	3 40
Package dimensions	620 x 420 x 670 H mm
Pallet dimensions	1200 x 800 x 2410 H mm

R

Stacked edge height	314 mm
Usable stacked height / with lid	310 mm/ 312 mm
Usable internal dimensions	555 x 355 x 321 H mm
Volume	60 litres
Pieces per pack / pallet	3 40
Package dimensions	620 x 420 x 670 H mm
Pallet dimensions	1200 x 800 x 2410 H mm

DATASHEET

<< CONTINUED ON PREVIOUS PAGE

600 x 400 mm H 325 mm

	ARTICLE	SEPARATE LID	HINGED LID	GR.	PACKAGING		UNIT PRICE €	
					Qty. per pack.	Qty. per pallet		
1	AT 64SE 5101	■		720	10	240		
	AT 64SE 51XB	■		720	10	240		
	AT 64SE 5207	■		806	10	240		
2	AT 64HG 5101		■	700	10	320		
	AT 64HG 51XB		■	700	10	320		
	AT 64HG 5207		■	784	10	320		
	AT 64HG 5401		■	732	10	320		
	AT 64HG 5900		■	700	10	320		
3	SPRING 0099	Document holder spring			10			
4	AT LOCK 8113	Pair closing clips			10			
5	AT LH64 5107	Label holders			10			
6	LB 21081 0325	A4 sheet with 3 labels			25			
ARTICLE ON REQUEST								
1	AT 64SE 5401	■		752	10	240		
	AT 64SE 5900	■		720	10	240		



1



2



3



4



5

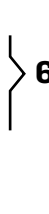

6

DATASHEET

Separate lid	600 x 400 mm
1 Pieces per pack. / dims.	10 / 600 x 400 x 100 H mm
Pieces per pallet / dims.	240 / 1200 x 800 x 1000 H mm
Hinged lid	600 x 400 mm
2 Pieces per pack. / dims.	10 / 600 x 400 x 100 H mm
Pieces per pallet / dims.	320 / 1200 x 800 x 1000 H mm
Document holder spring	
3 Pieces per pack	10
Pair closing clips	
4 Pieces per pack	10
Label holders	215 x 85 H mm
5 Pieces per pack	10
A4 sheet with 3 labels	210 x 81 H mm
6 Pieces per pack	25

iMilani srl reserves the right to alter the characteristics of products without notice. The values shown are nominal, with a +/- 1% tolerance for size, depending on the material, and a +/- 3% for weight.

	ARTICLE	WALLS		BOTTOM			HANDLES		GR.	PACKAGING		UNIT PRICE €
		Closed	Perforated	Closed	Perforated	Reinforced	Closed	Open		Qty. per pack.	Qty. per pallet	
B	AT 6443B 5101	■		■			■		3752	1	20	
	AT 6443B 51XB	■		■			■		3752	1	20	
R	AT 6443R 5101		■	■			■		3502	1	20	
	AT 6443R 51XB		■	■			■		3502	1	20	
ARTICLE ON REQUEST												
B	AT 6443B 5207	■		■			■		4202	1	20	
	AT 6443B 5900	■		■			■		3752	1	20	
R	AT 6443R 5207		■	■			■		3922	1	20	
	AT 6443R 5900		■	■			■		3502	1	20	



B

Closed bottom
Load capacity 20 kg



R

Closed bottom
Load capacity 20 kg



B

Stacked edge height	419 mm
Usable stacked height / with lid	415 mm/ 417 mm
Usable internal dimensions	555 x 355 x 426 H mm
Volume	90 litres
Pieces per pack / pallet	📦 1 🚚 20
Package dimensions	620 x 450 x 450 H mm
Pallet dimensions	1200 x 800 x 2256 H mm







R

Stacked edge height	419 mm
Usable stacked height / with lid	415 mm/ 417 mm
Usable internal dimensions	555 x 355 x 426 H mm
Volume	90 litres
Pieces per pack / pallet	📦 1 🚚 20
Package dimensions	620 x 450 x 450 H mm
Pallet dimensions	1200 x 800 x 2256 H mm

DATASHEET











600 x 400 mm H 430 mm

	ARTICLE	SEPARATE LID	HINGED LID	GR.	PACKAGING		UNIT PRICE €	
					Qty. per pack.	Qty. per pallet		
1	AT 64SE 5101	■		720	10	240		
	AT 64SE 51XB	■		720	10	240		
	AT 64SE 5207	■		806	10	240		
2	AT 64HG 5101		■	700	10	320		  
	AT 64HG 51XB		■	700	10	320		
	AT 64HG 5207		■	784	10	320		
	AT 64HG 5401		■	732	10	320		
	AT 64HG 5900		■	700	10	320		
3	SPRING 0099	Document holder spring			10			
4	AT LOCK 8113	Pair closing clips			10			
5	AT LH64 5107	Label holders			10			
6	LB 21081 0325	A4 sheet with 3 labels			25			
ARTICLE ON REQUEST								
1	AT 64SE 5401	■		752	10	240		 
	AT 64SE 5900	■		720	10	240		



DATASHEET

Separate lid	600 x 400 mm
1 Pieces per pack. / dims.	 10 / 600 x 400 x 100 H mm
Pieces per pallet / dims.	 240 / 1200 x 800 x 1000 H mm
Hinged lid	600 x 400 mm
2 Pieces per pack. / dims.	 10 / 600 x 400 x 100 H mm
Pieces per pallet / dims.	 320 / 1200 x 800 x 1000 H mm
Document holder spring	
3 Pieces per pack	 10
Pair closing clips	
4 Pieces per pack	 10
Label holders	215 x 85 H mm
5 Pieces per pack	 10
A4 sheet with 3 labels	210 x 81 H mm
6 Pieces per pack	 25

iMilani srl reserves the right to alter the characteristics of products without notice. The values shown are nominal, with a +/- 1% tolerance for size, depending on the material, and a +/- 3% for weight.

	ARTICLE	WALLS			BOTTOM			HANDLES		GR.	PACKAGING		UNIT PRICE €
		Side window 400 mm	Side window 600 mm	Closed	Perforated	Reinforced	Closed	Open	Qty. per pack.		Qty. per pallet		
U	AT 6443U 5101	■		■				■		3746	1	20	
	AT 6443U 51XB	■		■				■		3746	1	20	
V	AT 6443V 5101		■	■				■		3626	1	20	
	AT 6443V 51XB		■	■				■		3626	1	20	
ARTICLE ON REQUEST													
U	AT 6443U 5207	■		■				■		4196	1	20	
	AT 6443U 5900	■		■				■		3746	1	20	
V	AT 6443V 5207		■	■				■		4061	1	20	
	AT 6443V 5900		■	■				■		3626	1	20	



U

Closed bottom
Load capacity 20 kg



V

Closed bottom
Load capacity 20 kg



U

Stacked edge height	419 mm
Usable stacked height / with lid	415 mm/ 417 mm
Usable internal dimensions	555 x 355 x 426 H mm
Size of the opening	262 mm x 184 H mm
Volume	90 litres
Pieces per pack / pallet	📦 1 🚚 20
Package dimensions	620 x 450 x 450 H mm
Pallet dimensions	1200 x 800 x 2256 H mm

V

Stacked edge height	419 mm
Usable stacked height / with lid	415 mm/ 417 mm
Usable internal dimensions	555 x 355 x 426 H mm
Size of the opening	464 mm x 182 H mm
Volume	90 litres
Pieces per pack / pallet	📦 1 🚚 20
Package dimensions	620 x 450 x 450 H mm
Pallet dimensions	1200 x 800 x 2256 H mm

DATASHEET

◀ CONTINUED ON PREVIOUS PAGE

ARTICLES ON REQUEST

Minimum order200 pieces
Delivery guaranteed within.....6 weeks

600 x 400 mm H 430 mm

	ARTICLE	SEPARATE LID	HINGED LID	GR.	PACKAGING		UNIT PRICE €	
					Qty. per pack.	Qty. per pallet		
1	AT 64SE 5101	■		720	10	240		
	AT 64SE 51XB	■		720	10	240		
	AT 64SE 5207	■		806	10	240		
2	AT 64HG 5101		■	700	10	320		
	AT 64HG 51XB		■	700	10	320		
	AT 64HG 5207		■	784	10	320		
	AT 64HG 5401		■	732	10	320		
	AT 64HG 5900		■	700	10	320		
3	SPRING 0099	Document holder spring			10			
4	AT LOCK 8113	Pair closing clips			10			
5	AT LH64 5107	Label holders			10			
6	LB 21081 0325	A4 sheet with 3 labels			25			
ARTICLE ON REQUEST								
1	AT 64SE 5401	■		752	10	240		
	AT 64SE 5900	■		720	10	240		



1



2



3



4



5

6

DATASHEET

Separate lid	600 x 400 mm
1 Pieces per pack. / dims.	10 / 600 x 400 x 100 H mm
Pieces per pallet / dims.	240 / 1200 x 800 x 1000 H mm
Hinged lid	600 x 400 mm
2 Pieces per pack. / dims.	10 / 600 x 400 x 100 H mm
Pieces per pallet / dims.	320 / 1200 x 800 x 1000 H mm
Document holder spring	
3 Pieces per pack	10
Pair closing clips	
4 Pieces per pack	10
Label holders	215 x 85 H mm
5 Pieces per pack	10
A4 sheet with 3 labels	210 x 81 H mm
6 Pieces per pack	25

1

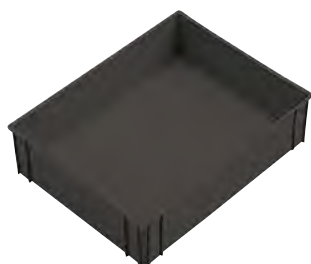

2



3



4



5



Per container

600 x 400 mm

	ARTICLE	1 PARTITION	2 PARTITIONS	4 PARTITIONS	GR.	PACKAGING		UNIT PRICE €	
						Qty. per pack.	Qty. per pallet		
1	AT 64S1 5207	■			459	10	160	6.08	
	AT 64S1 5407	■			428	10	160	3.39	
2	AT 64S2 5207		■		493	10	160	6.64	
	AT 64S2 5407		■		460	10	160	3.60	
3	AT 64S4 5207			■	524	10	160	7.22	
	AT 64S4 5407			■	489	10	160	3.83	
4	AT 64S0 5207	■			322	20	320	4.97	
	AT 64S0 5407	■			345	20	320	2.78	
5	AT LID6 6896	Transparent lid					20		3.70



Subdivision with 1 and 2 compartments



Subdivision with 1 and 4 compartments



Subdivision with 2 and 4 compartments

1	Partition box 1 partition	357 x 278 x 90 H mm
	Pieces per pack / pallet	📦 10 🚚 160
	Package dimensions	565 x 375 x 460 H mm
	Pallet dimensions	1200 x 800 x 1990 H mm
2	Partition box 2 partitions	357 x 278 x 90 H mm
	Pieces per pack / pallet	📦 10 🚚 160
	Package dimensions	565 x 375 x 460 H mm
	Pallet dimensions	1200 x 800 x 1990 H mm
3	Partition box 4 partitions	357 x 278 x 90 H mm
	Pieces per pack / pallet	📦 10 🚚 160
	Package dimensions	565 x 375 x 460 H mm
	Pallet dimensions	1200 x 800 x 1990 H mm
4	Partition box 1 partition	277 x 177 x 99 H mm
	Pieces per pack / pallet	📦 20 🚚 320
	Package dimensions	565 x 375 x 460 H mm
	Pallet dimensions	1200 x 800 x 1990 H mm
5	Transparent polystyrene lid	
	Pieces per pack	📦 20
	Package dimensions	365 x 295 x 180 H mm

600 x 400 mm

	ARTICLE	H 45	H 70	H 90	H 120	H 180	GR.	PACKAGING		UNIT PRICE €
								Qty. per pack.	Qty. per pallet	
1	DI 35545 5101	■						10		1.00
	DI 35545 5207	■						10		1.76
	DI 55545 5101	■						10		1.32
	DI 55545 5207	■						10		2.51
2	DI 35570 5101		■					10		1.19
	DI 35570 5207		■					10		2.42
	DI 55570 5101		■					10		1.63
	DI 55570 5207		■					10		3.60
3	DI 35590 5101			■				10		1.40
	DI 35590 5207			■				10		3.05
	DI 55590 5101			■				10		1.87
	DI 55590 5207			■				10		4.45
4	DI 35512 5101				■			10		1.78
	DI 35512 5207				■			10		3.86
	DI 55512 5101				■			10		2.41
	DI 55512 5207				■			10		5.74
5	DI 35518 5101					■		10		2.36
	DI 35518 5207					■		10		5.74
	DI 55518 5101					■		10		3.16
	DI 55518 5207					■		10		8.29
6	DI 64SHT 5101							10		5.51
	DI 64SHT 5207							10		15.95

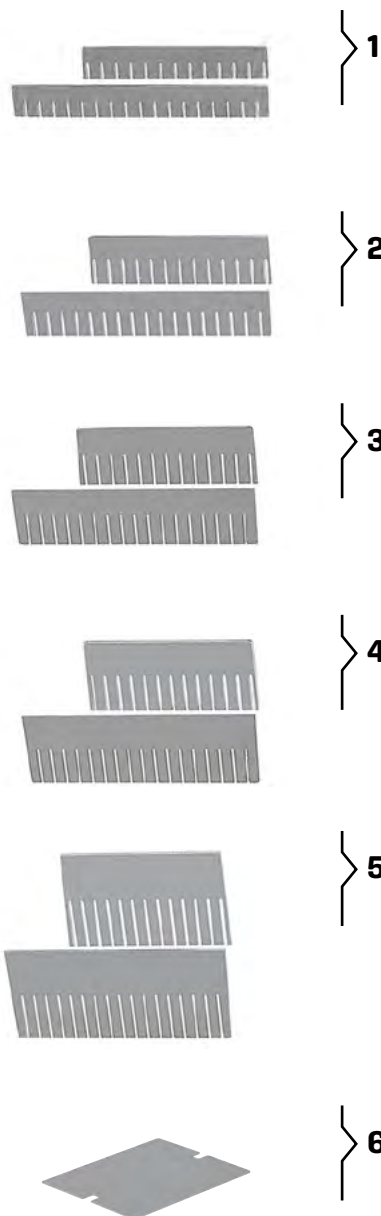

DATASHEET

1	
Comb divider 355 x 45 H mm per box 600 x 400 x 75H mm	10 items
Comb divider 555 x 45 H mm per box 600 x 400 x 75H mm	10 items
2	
Comb divider 355 x 70 H mm per box 600 x 400 x 120H mm	10 items
Comb divider 555 x 70 H mm per box 600 x 400 x 120H mm	10 items
3	
Comb divider 355 x 90 H mm per box 600 x 400 x 120H mm	10 items
Comb divider 555 x 90 H mm per box 600 x 400 x 120H mm	10 items
4	
Comb divider 355 x 120 H mm per box 600 x 400 x 170H mm	10 items
Comb divider 555 x 120 H mm per box 600 x 400 x 170H mm	10 items
5	
Comb divider 355 x 180 H mm per box 600 x 400 x 220H mm	10 items
Comb divider 555 x 180 H mm per box 600 x 400 x 220H mm	10 items
6	
Intermediate partition shelf 555 x 355 mm	10 items

Box for non-conforming material



400 x 300 mm H 220 mm
 600 x 400 mm H 120 mm
 600 x 400 mm H 220 mm
 600 x 400 mm H 320 mm

	ARTICLE	WALLS		BOTTOM			HANDLES		GR.	PACKAGING		UNIT PRICE €
		Closed	Perforated	Closed	Perforated	Reinforced	Closed	Open		Qty. per pack.	Qty. per pallet	
A	AT 4322A ISO	■		■			■			4	80	
B	AT 6412A ISO	■		■			■			4	80	
C	AT 6422A ISO	■		■			■			2	40	
D	AT 6432A ISO	■		■			■			3	40	
ACCESSORIES												
1	AT 43HG ISO									10	640	
2	AT 64HG ISO									10	320	



A

iMilani
99



B



C



D



1



2

DATASHEET

Dimensions	400 x 300 x 220 H mm
A Pieces per pack. / dimens.	4 / 620 x 420 x 449 H mm
Pieces per pallet / dimens.	80 / 1200 x 800 x 2251 H mm
Dimensions	600 x 400 x 120 H mm
B Pieces per pack. / dimens.	4 / 620 x 420 x 467 H mm
Pieces per pallet / dimens.	80 / 1200 x 800 x 2341 H mm
Dimensions	600 x 400 x 220 H mm
C Pieces per pack. / dimens.	2 / 620 x 420 x 449 H mm
Pieces per pallet / dimens.	40 / 1200 x 800 x 2251 H mm
Dimensions	600 x 400 x 325 H mm
D Pieces per pack. / dimens.	3 / 620 x 420 x 670 H mm
Pieces per pallet / dimens.	40 / 1200 x 800 x 2410 H mm
Hinged lid dim.	400 x 300 mm
1 Pieces per pack. / dimens.	10 / 400 x 300 x 100 H mm
Pieces per pallet / dimens.	640 / 1200 x 800 x 1000 H mm
Hinged lid	600 x 400 mm
2 Pieces per pack. / dimens.	10 / 600 x 400 x 100 H mm
Pieces per pallet / dimens.	320 / 1200 x 800 x 1000 H mm

iMilani srl reserves the right to alter the characteristics of products without notice. The values shown are nominal, with a +/- 1% tolerance for size, depending on the material, and a +/- 3% for weight.

Reinforced bottom
Load capacity 60 kg



C



1

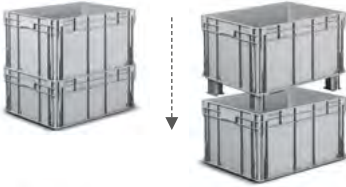

Order 4 feet

2

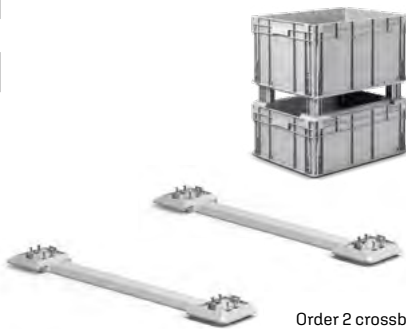

Order 2 crossbars

3



Order 4 wheels
AT WRCT 100/125
or alternatively those on
the page opposite

Accessories supplied mounted
When fitted with wheels, the boxes are not stackable

iMilani srl reserves the right to alter the characteristics of products without notice. The values shown are nominal, with a +/- 1% tolerance for size, depending on the material, and a +/- 3% for weight.

ARTICLE	WALLS		BOTTOM			HANDLES		GR.	PACKAGING		UNIT PRICE €
	Closed	Perforated	Closed	Perforated	Reinforced	Closed	Open		Qty. per pack.	Qty. per pallet	
AT 8612C 5101	■				■	■		3458	4	40	
AT 8612C 51XB	■				■	■		3458	4	40	
AT 8612C 5207	■				■	■		3873	4	40	
ARTICLE ON REQUEST											
AT 8612C 5401	■				■	■		3614	4	40	
AT 8612C 5900	■				■	■		3458	4	40	
ACCESSORIES											
AT FEET 5101								136	1		
AT FEET 51XB								136	1		
AT FEET 5207								152	1		
AT FEET 5401								142	1		
AT FEET 5900								136	1		
AT RUNN 5101								382	1		
AT RUNN 51XB								382	1		
AT RUNN 5207								428	1		
AT RUNN 5401								400	1		
AT RUNN 5900								382	1		
3 AT WRCT 100										1	
AT WRCT 125										1	

All accessories include fixing screws when required

C

Stacked edge height	105 mm
Usable stacked height / with lid	86 mm/ 93 mm
Usable internal dimensions	755 x 555 x 101 H mm
Volume	49 litres
Pieces per pack / pallet	4 40
Package dimensions	820 x 620 x 455H mm
Pallet dimensions	1200 x 800 x 2265 H mm

1

Feet with fixing screws	100 H mm
Pieces per pack	1

2

Crossbar	25 H mm
Pieces per pack	1

3

Swivel wheel in rubber	diameter 100 mm
Pieces per pack	1

ARTICLES ON REQUEST

Minimum order200 pieces
Delivery guaranteed within.....6 weeks

800 x 600 mm H 120 mm

ARTICLE	SEPARATE LID	GR.	PACKAGING		UNIT PRICE €	
			Qty. per pack.	Qty. per pallet		
AT 86SE 5101	■	1978	5	60		
1 AT 86SE 51XB	■	1978	5	60		
AT 86SE 5207	■	2215	5	60		
2 SPRING 0099	Document holder spring		10			
3	AT WRBT 100	Swivel wheel in rubber w/brake D. 100 mm	1			
	AT WRBT 125	Swivel wheel in rubber w/brake D. 125 mm	1			
4	AT WRCF 100	Swivel wheel in rubber D. 100 mm	1			
	AT WRCF 125	Swivel wheel in rubber D. 125 mm	1			
5	AT WNBT 100	Swivel wheel in nylon w/brake D. 100 mm	1			
	AT WNBT 125	Swivel wheel in nylon w/brake D. 125 mm	1			
6	AT WNCF 100	Fixed wheel in nylon D. 100 mm	1			
	AT WNCF 125	Fixed wheel in nylon D. 125 mm	1			
7	AT WHBT 125	Swivel wheel non-marking rubber w/brake D. 125 mm	1			
8	AT WHCF 125	Fixed wheel non-marking rubber D. 125 mm	1			
ARTICLE ON REQUEST						
1	AT 86SE 5401	■	2067	5	60	
	AT 86SE 5900	■	1978	5	60	

All accessories include fixing screws when required

DATASHEET

	Separate lid	800 x 600 mm
1	Pieces per pack / pallet	5 60
	Package dimensions	800 x 600 x 150 H mm
	Pallet dimensions	1200 x 800 x 860 H mm
2	Document holder spring	
	Pieces per pack	10
3	Swivel wheel in rubber with brake D. 100 mm footprint 128 H mm	
	Swivel wheel in rubber with brake D. 125 mm footprint 155 H mm	
4	Rubber fixed wheel diameter 100 mm - footprint 128 mm H	
	Rubber fixed wheel diameter 125 mm - footprint 155 mm H	
5	Swivel wheel in nylon with brake diameter 100 mm footprint 128 H mm	
	Swivel wheel in nylon with brake diameter 125 mm footprint 155 H mm	
6	Fixed wheel in nylon diameter 100 mm - footprint 128 mm H	
	Fixed wheel in nylon diameter 125 mm - footprint 155 mm H	
7	Swivel wheel in non-marking rubber with brake diameter 125 mm - footprint 155 H mm	
8	Fixed wheel in non-marking rubber diameter 125 mm - footprint 155 H mm	



iMiCUBE
101

ATHENA 8612

iMilani
innovative
italian
ideas

iMilani srl reserves the right to alter the characteristics of products without notice. The values shown are nominal, with a +/- 1% tolerance for size, depending on the material, and a +/- 3% for weight.

800 x 600 mm H 170 mm

ARTICLE	SEPARATE LID	GR.	PACKAGING		UNIT PRICE €
			Qty. per pack.	Qty. per pallet	
AT 86SE 5101	■	1978	5	60	
1 AT 86SE 51XB	■	1978	5	60	
AT 86SE 5207	■	2215	5	60	
2 SPRING 0099	Document holder spring		10		
3 AT LH64 5107	Label holders		10		
4 LB 21081 0325	A4 sheet with 3 labels		25		
5 AT WRBT 100	Swivel wheel in rubber w/brake D. 100 mm		1		
AT WRBT 125	Swivel wheel in rubber w/brake D. 125 mm		1		
6 AT WRCF 100	Swivel wheel in rubber D. 100 mm		1		
AT WRCF 125	Swivel wheel in rubber D. 125 mm		1		
7 AT WNBT 100	Swivel wheel in nylon w/brake D. 100 mm		1		
AT WNBT 125	Swivel wheel in nylon w/brake D. 125 mm		1		
8 AT WNCF 100	Fixed wheel in nylon D. 100 mm		1		
AT WNCF 125	Fixed wheel in nylon D. 125 mm		1		
9 AT WHBT 125	Swivel wheel non-marking rubber w/brake D. 125 mm		1		
10 AT WHCF 125	Fixed wheel non-marking rubber D. 125 mm		1		
ARTICLE ON REQUEST					
1 AT 86SE 5401	■	2067	5	60	
AT 86SE 5900	■	1978	5	60	

All accessories include fixing screws when required



ECOGREEN

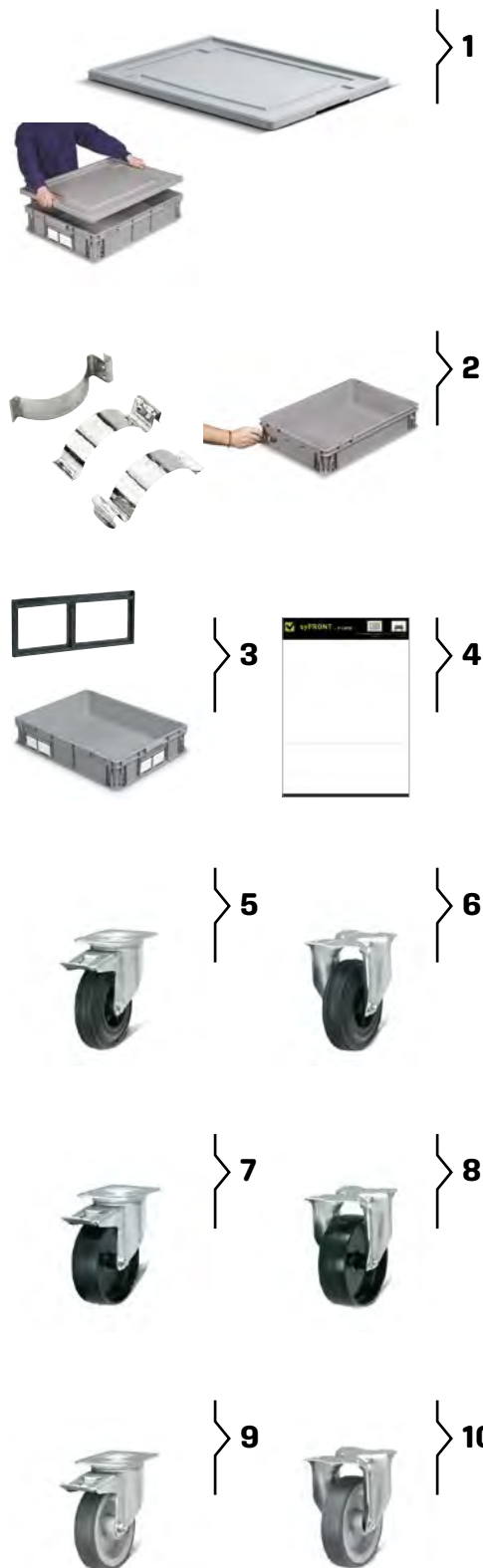

iMiCUBE
103

DATASHEET

Separate lid	800 x 600 mm
1 Pieces per pack / pallet	5 60
Package dimensions	800 x 600 x 150 H mm
Pallet dimensions	1200 x 800 x 860 H mm
Document holder spring	
2 Pieces per pack	10
Label holders	
3 Pieces per pack	215 x 85 H mm 10
A4 sheet with 3 labels	
4 Pieces per pack	210 x 81 H mm 25
Swivel wheel in rubber with brake D. 100 mm footprint 128 H mm	
5 Swivel wheel in rubber with brake D. 125 mm footprint 155 H mm	
Rubber fixed wheel diameter 100 mm - footprint 128 mm H	
6 Rubber fixed wheel diameter 125 mm - footprint 155 mm H	
Swivel wheel in nylon with brake diameter 100 mm footprint 128 H mm	
7 Swivel wheel in nylon with brake diameter 125 mm footprint 155 H mm	
Fixed wheel in nylon diameter 100 mm - footprint 128 mm H	
8 Fixed wheel in nylon diameter 125 mm - footprint 155 mm H	
Swivel wheel in non-marking rubber with brake diameter 125 mm - footprint 155 H mm	
9 Fixed wheel in non-marking rubber diameter 125 mm - footprint 155 H mm	
10	

iMilani srl reserves the right to alter the characteristics of products without notice. The values shown are nominal, with a +/- 1% tolerance for size, depending on the material, and a +/- 3% for weight.

800 x 600 mm H 220 mm

ARTICLE	SEPARATE LID	GR.	PACKAGING		UNIT PRICE €
			Qty. per pack.	Qty. per pallet	
AT 86SE 5101	■	1978	5	60	
1 AT 86SE 51XB	■	1978	5	60	
AT 86SE 5207	■	2215	5	60	
2 SPRING 0099	Document holder spring		10		
3 AT LH64 5107	Label holders		10		
4 LB 21081 0325	A4 sheet with 3 labels		25		
5 AT WRBT 100	Swivel wheel in rubber w/brake D. 100 mm		1		
AT WRBT 125	Swivel wheel in rubber w/brake D. 125 mm		1		
6 AT WRCF 100	Swivel wheel in rubber D. 100 mm		1		
AT WRCF 125	Swivel wheel in rubber D. 125 mm		1		
7 AT WNBT 100	Swivel wheel in nylon w/brake D. 100 mm		1		
AT WNBT 125	Swivel wheel in nylon w/brake D. 125 mm		1		
8 AT WNCF 100	Fixed wheel in nylon D. 100 mm		1		
AT WNCF 125	Fixed wheel in nylon D. 125 mm		1		
9 AT WHBT 125	Swivel wheel non-marking rubber w/brake D. 125 mm		1		
10 AT WHCF 125	Fixed wheel non-marking rubber D. 125 mm		1		
ARTICLE ON REQUEST					
1 AT 86SE 5401	■	2067	5	60	
AT 86SE 5900	■	1978	5	60	

All accessories include fixing screws when required



ECOGREEN

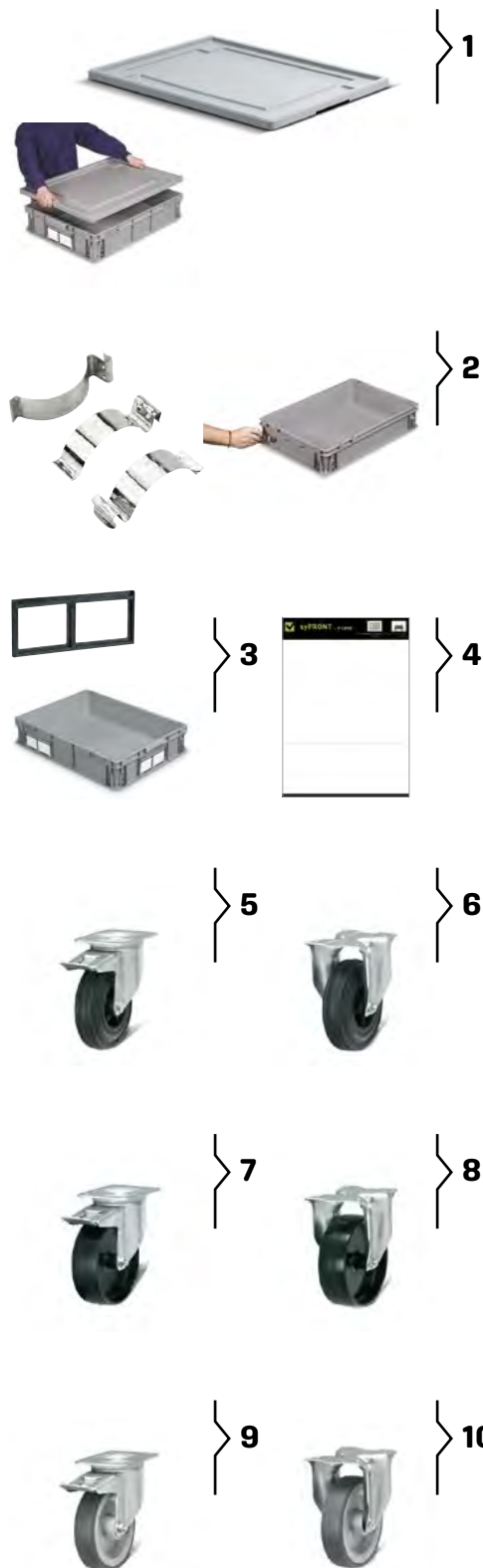

iMiCUBE
105

DATASHEET

Separate lid	800 x 600 mm
1 Pieces per pack / pallet	5 60
Package dimensions	800 x 600 x 150 H mm
Pallet dimensions	1200 x 800 x 860 H mm
Document holder spring	
2 Pieces per pack	10
Label holders	
3 Pieces per pack	215 x 85 H mm 10
A4 sheet with 3 labels	
4 Pieces per pack	210 x 81 H mm 25
Swivel wheel in rubber with brake D. 100 mm footprint 128 H mm	
5 Swivel wheel in rubber with brake D. 125 mm footprint 155 H mm	
Rubber fixed wheel diameter 100 mm - footprint 128 mm H	
6 Rubber fixed wheel diameter 125 mm - footprint 155 mm H	
Swivel wheel in nylon with brake diameter 100 mm footprint 128 H mm	
7 Swivel wheel in nylon with brake diameter 125 mm footprint 155 H mm	
Fixed wheel in nylon diameter 100 mm - footprint 128 mm H	
8 Fixed wheel in nylon diameter 125 mm - footprint 155 mm H	
Swivel wheel in non-marking rubber with brake diameter 125 mm - footprint 155 H mm	
9 Fixed wheel in non-marking rubber diameter 125 mm - footprint 155 H mm	
10	

iMilani srl reserves the right to alter the characteristics of products without notice. The values shown are nominal, with a +/- 1% tolerance for size, depending on the material, and a +/- 3% for weight.

800 x 600 mm H 320 mm

ARTICLE	SEPARATE LID	GR.	PACKAGING		UNIT PRICE €
			Qty. per pack.	Qty. per pallet	
AT 86SE 5101	■	1978	5	60	
1 AT 86SE 51XB	■	1978	5	60	
AT 86SE 5207	■	2215	5	60	
2 SPRING 0099	Document holder spring		10		
3 AT LH64 5107	Label holders		10		
4 LB 21081 0325	A4 sheet with 3 labels		25		
5 AT WRBT 100	Swivel wheel in rubber w/brake D. 100 mm		1		
AT WRBT 125	Swivel wheel in rubber w/brake D. 125 mm		1		
6 AT WRCF 100	Swivel wheel in rubber D. 100 mm		1		
AT WRCF 125	Swivel wheel in rubber D. 125 mm		1		
7 AT WNBT 100	Swivel wheel in nylon w/brake D. 100 mm		1		
AT WNBT 125	Swivel wheel in nylon w/brake D. 125 mm		1		
8 AT WNCF 100	Fixed wheel in nylon D. 100 mm		1		
AT WNCF 125	Fixed wheel in nylon D. 125 mm		1		
9 AT WHBT 125	Swivel wheel non-marking rubber w/brake D. 125 mm		1		
10 AT WHCF 125	Fixed wheel non-marking rubber D. 125 mm		1		
ARTICLE ON REQUEST					
1 AT 86SE 5401	■	2067	5	60	
AT 86SE 5900	■	1978	5	60	

All accessories include fixing screws when required



ECOGREEN

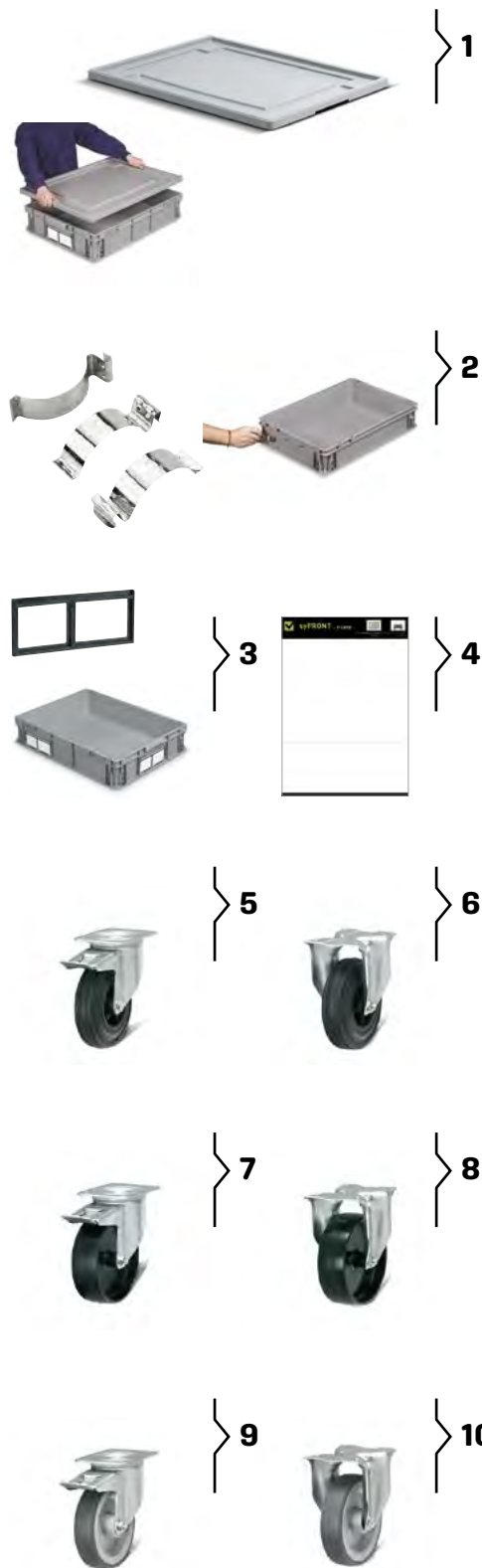

iMiCUBE
107

DATASHEET

Separate lid	800 x 600 mm
1 Pieces per pack / pallet	5 60
Package dimensions	800 x 600 x 150 H mm
Pallet dimensions	1200 x 800 x 860 H mm
Document holder spring	
2 Pieces per pack	10
Label holders	
3 Pieces per pack	215 x 85 H mm 10
A4 sheet with 3 labels	
4 Pieces per pack	210 x 81 H mm 25
Swivel wheel in rubber with brake D. 100 mm footprint 128 H mm	
5 Swivel wheel in rubber with brake D. 125 mm footprint 155 H mm	
Rubber fixed wheel diameter 100 mm - footprint 128 mm H	
6 Rubber fixed wheel diameter 125 mm - footprint 155 mm H	
Swivel wheel in nylon with brake diameter 100 mm footprint 128 H mm	
7 Swivel wheel in nylon with brake diameter 125 mm footprint 155 H mm	
Fixed wheel in nylon diameter 100 mm - footprint 128 mm H	
8 Fixed wheel in nylon diameter 125 mm - footprint 155 mm H	
Swivel wheel in non-marking rubber with brake diameter 125 mm - footprint 155 H mm	
9 Fixed wheel in non-marking rubber diameter 125 mm - footprint 155 H mm	
10	

iMilani srl reserves the right to alter the characteristics of products without notice. The values shown are nominal, with a +/- 1% tolerance for size, depending on the material, and a +/- 3% for weight.

Reinforced bottom
Load capacity 60 kg



C



1

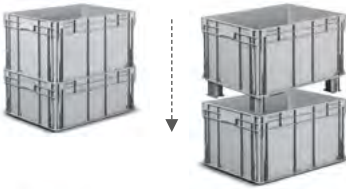

Order 4 feet

2

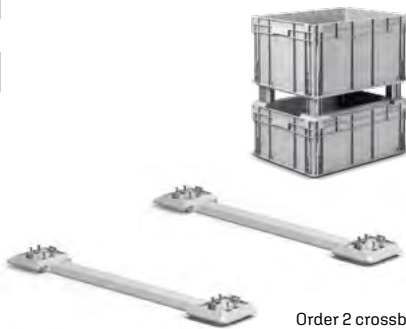

Order 2 crossbars

3



Order 4 wheels
AT WRCT 100/125
or alternatively those on
the page opposite

Accessories supplied mounted

ARTICLE	WALLS		BOTTOM			HANDLES		GR.	PACKAGING		UNIT PRICE €
	Closed	Perforated	Closed	Perforated	Reinforced	Closed	Open		Qty. per pack.	Qty. per pallet	
AT 8643C 5101	■				■	■		6238	1	10	
C AT 8643C 51XB	■				■	■		6238	1	10	
AT 8643C 5207	■				■	■		6986	1	10	
ARTICLE ON REQUEST											
AT 8643C 5401	■				■	■		6518	1	10	
AT 8643C 5900	■				■	■		6238	1	10	
ACCESSORIES											
AT FEET 5101								136	1		
AT FEET 51XB								136	1		
1 AT FEET 5207	Foot Order 4 pieces							152	1		
AT FEET 5401								142	1		
AT FEET 5900								136	1		
AT RUNN 5101								382	1		
AT RUNN 51XB	Crossbar to be slotted under the feet							382	1		
2 AT RUNN 5207	AT FEET Order 2 pieces							428	1		
AT RUNN 5401								400	1		
AT RUNN 5900								382	1		
3 AT WRCT 100	Swivel wheel D. 100 mm in rubber								1		
AT WRCT 125	Swivel wheel D. 125 mm in rubber								1		

All accessories include fixing screws when required

C

Stacked edge height	415 mm
Usable stacked height / with lid	396 mm/ 403 mm
Usable internal dimensions	755 x 555 x 411 H mm
Volume	175 litres
Pieces per pack / pallet	1 10
Package dimensions	820 x 620 x 450H mm
Pallet dimensions	1200 x 800 x 2240 H mm

1

Feet with fixing screws	100 H mm
Pieces per pack	1

2

Crossbar	25 H mm
Pieces per pack	1

3

Swivel wheel in rubber	diameter 100 mm
Pieces per pack	1

ARTICLES ON REQUEST

Minimum order200 pieces
Delivery guaranteed within.....6 weeks

800 x 600 mm H 430 mm

ARTICLE	SEPARATE LID	GR.	PACKAGING		UNIT PRICE €
			Qty. per pack.	Qty. per pallet	
AT 86SE 5101	■	1978	5	60	
1 AT 86SE 51XB	■	1978	5	60	
AT 86SE 5207	■	2215	5	60	
2 SPRING 0099	Document holder spring		10		
3 AT LH 64 5107	Label holders		10		
4 LB 21081 0325	A4 sheet with 3 labels		25		
5 AT WRBT 100	Swivel wheel in rubber w/brake D. 100 mm		1		
AT WRBT 125	Swivel wheel in rubber w/brake D. 125 mm		1		
6 AT WRCF 100	Swivel wheel in rubber D. 100 mm		1		
AT WRCF 125	Swivel wheel in rubber D. 125 mm		1		
7 AT WNBT 100	Swivel wheel in nylon w/brake D. 100 mm		1		
AT WNBT 125	Swivel wheel in nylon w/brake D. 125 mm		1		
8 AT WNCF 100	Fixed wheel in nylon D. 100 mm		1		
AT WNCF 125	Fixed wheel in nylon D. 125 mm		1		
9 AT WHBT 125	Swivel wheel non-marking rubber w/brake D. 125 mm		1		
10 AT WHCF 125	Fixed wheel non-marking rubber D. 125 mm		1		
ARTICLE ON REQUEST					
1 AT 86SE 5401	■	2067	5	60	
AT 86SE 5900	■	1978	5	60	

All accessories include fixing screws when required

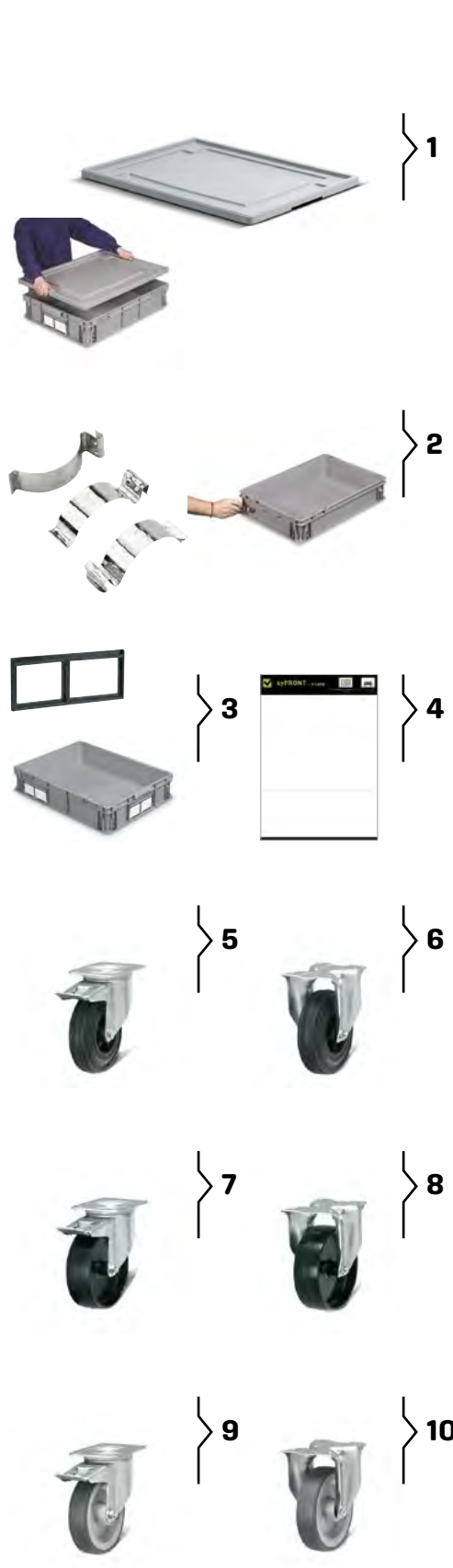

iMiCUBE
109

DATASHEET

Separate lid	800 x 600 mm
1 Pieces per pack / pallet	5 60
Package dimensions	800 x 600 x 150 H mm
Pallet dimensions	1200 x 800 x 860 H mm
Document holder spring	
2 Pieces per pack	10
Label holders	
3 Pieces per pack	10
A4 sheet with 3 labels	
4 Pieces per pack	25
Swivel wheel in rubber with brake D. 100 mm footprint 128 H mm	
5 Swivel wheel in rubber with brake D. 125 mm footprint 155 H mm	
Rubber fixed wheel diameter 100 mm - footprint 128 mm H	
6 Rubber fixed wheel diameter 125 mm - footprint 155 mm H	
Swivel wheel in nylon with brake diameter 100 mm footprint 128 H mm	
7 Swivel wheel in nylon with brake diameter 125 mm footprint 155 H mm	
Fixed wheel in nylon diameter 100 mm - footprint 128 mm H	
8 Fixed wheel in nylon diameter 125 mm - footprint 155 mm H	
Swivel wheel in non-marking rubber with brake diameter 125 mm - footprint 155 H mm	
9 Fixed wheel in non-marking rubber diameter 125 mm - footprint 155 H mm	
10	

iMilani srl reserves the right to alter the characteristics of products without notice. The values shown are nominal, with a +/- 1% tolerance for size, depending on the material, and a +/- 3% for weight.

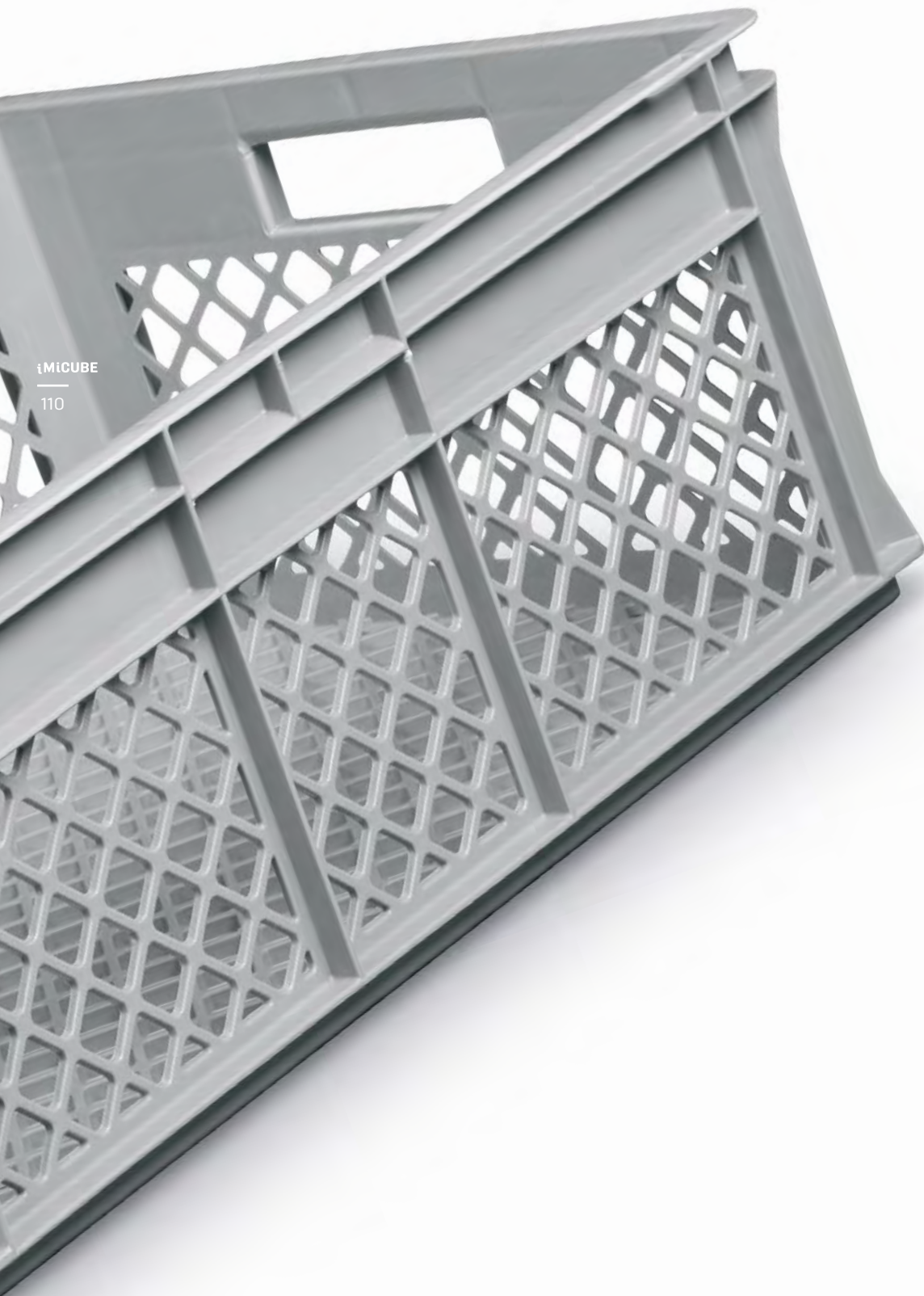

iMiCUBE
110



ATHENA LIGHT

The Athena Light box series has been designed and built in alignment with new techniques for the warehousing and transport of a wide range of materials. Lightweight and manageable, the boxes are available in grey or turquoise polypropylene.

Unlike the Athena series, they are available only in the 600 x 400 x 220H mm size and have larger holes, allowing for greater ventilation and visibility of the product.

HANDLES

open handle



closed handle



WALLS

closed walls



perforated walls



iMiCUBE

111

BOTTOMS

closed bottom



perforated bottom

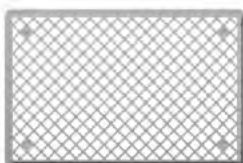

comb dividers
and intermediate shelf



LIDS

hinged



with handle



closing clips



closure with seal



The lid of the Athena Light series box in the version with hinges and with handles can be closed with a sliding fastener in nylon.

Document holder spring



Refer to the Athena section
on page 97

The Document holder spring snaps onto the long or short side of the Athena Light box and can be used to secure transport notes or other documents.

ARTICLE	WALLS		BOTTOM			HANDLES		GR.	PACKAGING		UNIT PRICE €
	Closed	Perforated	Closed	Perforated	Reinforced	Closed	Open		Qty. per pack.	Qty. per pallet	
AL 6422A 5101	■		■			■		1960	2	40	
AL 6422A 51XB	■		■			■		1960	2	40	
AL 6422A 5207	■		■			■		2195	2	40	
AL 6422B 5101	■		■				■	1950	2	40	
AL 6422B 51XB	■		■				■	1950	2	40	
AL 6422S 5101		■		■			■	1476	2	40	
AL 6422S 51XB		■		■			■	1476	2	40	
ARTICLE ON REQUEST											
AL 6422A 5401	■		■			■		2048	2	40	
AL 6422A 5900	■		■			■		1960	2	40	
AL 6422B 5207	■		■				■	2184	2	40	
AL 6422B 5900	■		■				■	1950	2	40	
AL 6422S 5207		■		■			■	1653	2	40	
AL 6422S 5900		■		■			■	1476	2	40	

ECOGREEN



A

Closed bottom
Load capacity 20 kg



B

Closed bottom
Load capacity 20 kg



S

Perforated bottom
Load capacity 15 kg



A	
Stacked edge height	206 mm
Usable stacked height / with lid	201 mm/ 207 mm
Usable internal dimensions	555 x 355 x 216 H mm
Volume	40 litres
Pieces per pack / pallet	2 40
Package dimensions	620 x 420 x 449 H mm
Pallet dimensions	1200 x 800 x 2251 H mm
B	
Stacked edge height	206 mm
Usable stacked height / with lid	201 mm/ 207 mm
Usable internal dimensions	555 x 355 x 216 H mm
Volume	40 litres
Pieces per pack / pallet	2 40
Package dimensions	620 x 420 x 449 H mm
Pallet dimensions	1200 x 800 x 2251 H mm
S	
Stacked edge height	206 mm
Usable stacked height / with lid	201 mm/ 207 mm
Usable internal dimensions	555 x 355 x 216 H mm
Volume	40 litres
Pieces per pack / pallet	2 40
Package dimensions	620 x 420 x 449 H mm
Pallet dimensions	1200 x 800 x 2251 H mm

ARTICLES ON REQUEST

Minimum order200 pieces
Delivery guaranteed within.....6 weeks

600 x 400 mm H 220 mm

	ARTICLE	SEPARATE LID	HINGED LID	GR.	PACKAGING		UNIT PRICE €	
					Qty. per pack.	Qty. per pallet		
1	AT 64SE 5101	■		720	10	240		♻️ PP
	AT 64SE 51XB	■		720	10	240		♻️ PP
	AT 64SE 5207	■		806	10	240		♻️ PP
2	AT 64HG 5101		■	700	10	320		♻️ PP
	AT 64HG 51XB		■	700	10	320		♻️ PP
	AT 64HG 5207		■	784	10	320		♻️ PP
	AT 64HG 5401		■	731	10	320		♻️ PP ECOGREEN ♻️
	AT 64HG 5900		■	700	10	320		♻️ PP ♻️
3	SPRING 0099	Document holder spring				10		
4	AT LOCK 8113	Pair closing clips				10		
ARTICLE ON REQUEST								
1	AT 64SE 5401	■		752	10	240		♻️ PP ECOGREEN ♻️
	AT 64SE 5900	■		720	10	240		♻️ PP ♻️

Comb dividers on page 97 Athena section

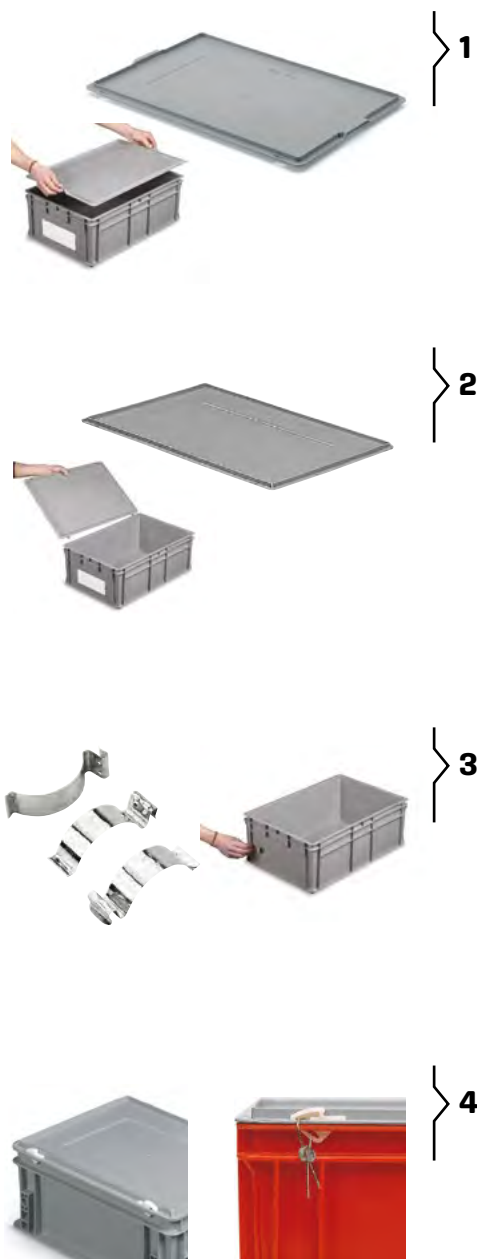

DATASHEET

	Separate lid	600 x 400 mm
1	Pieces per pack. / dimens.	♻️ 10 / 600 x 400 x 100 H mm
	Pieces per pallet / dimens.	♻️ 240 / 1200 x 800 x 1000 H mm
	Hinged lid	600 x 400 mm
2	Pieces per pack. / dimens.	♻️ 10 / 600 x 400 x 100 H mm
	Pieces per pallet / dimens.	♻️ 320 / 1200 x 800 x 1000 H mm
	Document holder spring	
3	Pieces per pack	♻️ 10
	Pair closing clips	
4	Pieces per pack	♻️ 10

iMilani srl reserves the right to alter the characteristics of products without notice. The values shown are nominal, with a +/- 1% tolerance for size, depending on the material, and a +/- 3% for weight.

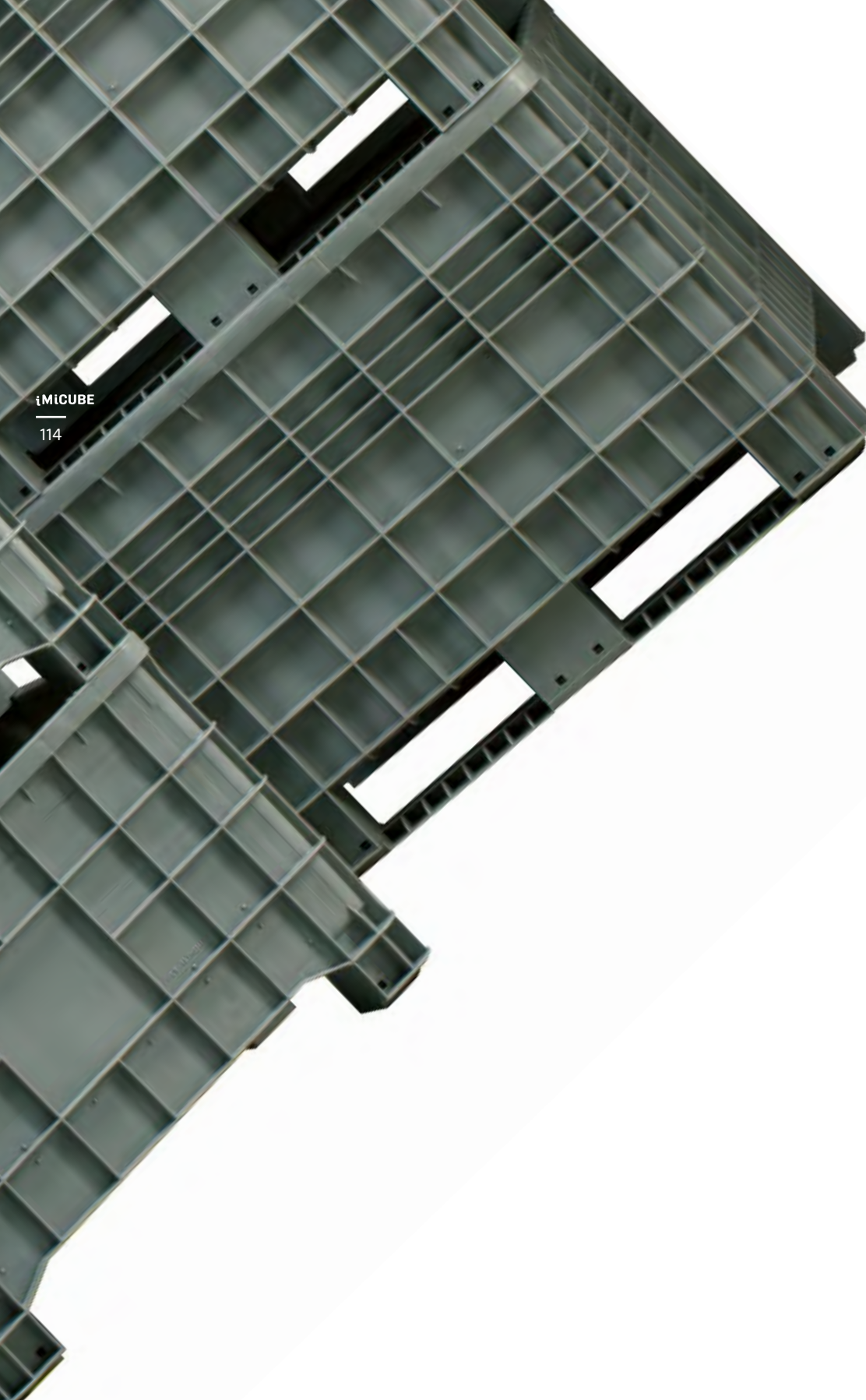

iMiCUBE
114



CONTAINER

Injection moulded container in High Density Polyethylene (HDPE), also suitable for food use. Fully recyclable material, initial melting guarantee and certification. Easy to clean and impervious to rust; insensitive to weight changes on contact with water.

Highly resistant to UV and infrared rays, high and low temperatures, acids and alkalis. Designed to be stackable, thus facilitating storage and handling operations.

VERSIONS

with 4 feet



with 2 skids



with 4 wheels



iMiCUBE

115

ACCESSORIES

separate lid



bar handle





1000 x 640 mm H 655 mm
 1165 x 790 mm H 800 mm
 1165 x 790 mm H 800 mm

	ARTICLE	4 FEET	6 FEET WITH SKIDS	VIRGIN PE-HD	REGENERATED PE-HD	KG	PACKAGING		UNIT PRICE €
							Qty. per pack.	Qty. per pallet	
A	CN 1006FJ4001	■		■		14.3	1	6	
	CN 1006FJ4007	■			■	14.3	1	6	
B	CN 1107FJ 4001	■		■		25	1	3	
	CN 1107FJ 4007	■			■	25	1	3	
C	CN 1107SJ 4001		■	■		26.2	1	3	
	CN 1107SJ 4007		■		■	26.2	1	3	

Raw material for black articles: Regenerated High Density Polyethylene

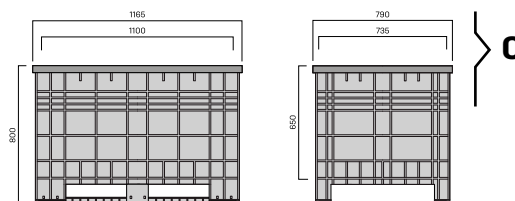
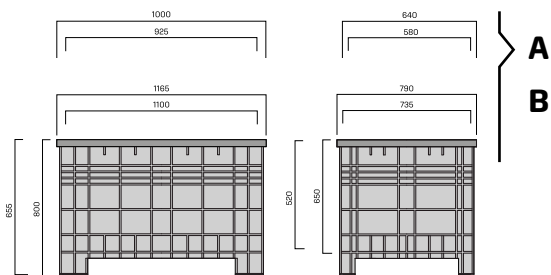

DATASHEET

A - CONTAINER WITH 4 FEET

Dimensions	1000 x 640 x 655H mm
Internal dimensions	925 x 580 x 520H mm
Load capacity	150 kg
Volume	280 litres
Pieces per pack / pallet	📦 1 🚚 6

B - CONTAINER WITH 4 FEET

Dimensions	1165 x 790 x 800H mm
Internal dimensions	1100 x 735 x 650H mm
Load capacity	250 kg
Volume	520 litres
Pieces per pack / pallet	📦 1 🚚 3

C - CONTAINER WITH 2 CROSSBARS

Dimensions	1165 x 790 x 800H mm
Internal dimensions	1100 x 735 x 650H mm
Load capacity	250 kg
Volume	520 litres
Pieces per pack / pallet	📦 1 🚚 3



iMilani srl reserves the right to alter the characteristics of products without notice. The values shown are nominal, with a +/- 1% tolerance for size, depending on the material, and a +/- 3% for weight.

Dimensions

1000 x 640 mm H 790/815 mm
1165 x 790 mm H 935/960 mm

	ARTICLE	WHEEL DIAMETER 100 MM	WHEEL DIAMETER 125 MM	OPTIONAL BAR HANDLE ATTACHMENT	WEIGHT WITHOUT WHEELS KG	PACKAGING		UNIT PRICE €
						Qty. per pack.	Qty. per pallet	
A	CN 1006R1J 4001	■		■	14.3	1	6	
	CN 1006R2J 4001		■	■	14.3	1	6	
B	CN 1107R1J 4001	■		■	25.0	1	3	
	CN 1107R2J 4001		■	■	25.0	1	3	

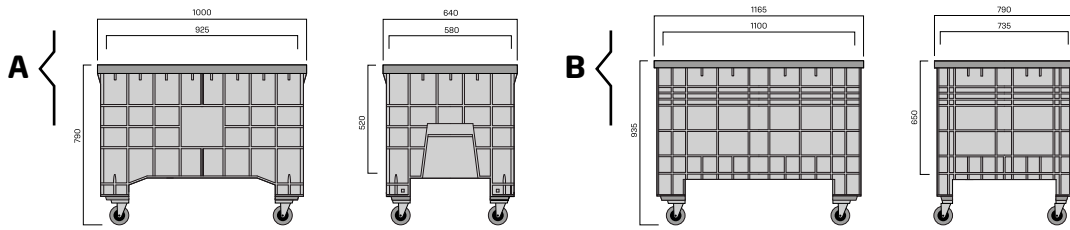

A	
Dimensions with wheels diam. 100 mm	1000 x 640 x 790H mm
Dimensions with wheels diam. 125 mm	1000 x 640 x 815H mm
Internal dimensions	925 x 580 x 520H mm
Wheels without brake	4
Load capacity	150 kg
Volume	280 litres
Pieces per pack / pallet	📦 1 🚚 6

B	
Dimensions with wheels diam. 100 mm	1165 x 790 x 935H mm
Dimensions with wheels diam. 125 mm	1165 x 790 x 960H mm
Internal dimensions	1100 x 735 x 650H mm
Wheels without brake	4
Load capacity	250 kg
Volume	520 litres
Pieces per pack / pallet	📦 1 🚚 3

1200 x 1000 mm H 760 mm

ARTICLE	4 FEET	9 FEET WITH 3 SKIDS	VIRGIN PE-HD	REGENERATED PE-HD	KG	PACKAGING		UNIT PRICE €
						Qty. per pack.	Qty. per pallet	
A CN 1210BJ 4001		■	■		38.5	1	3	



A



Special container for collecting used batteries
Lid to be ordered separately

ARTICLE	FOR CONTAINER CN121...	FOR CONTAINER CN100...	FOR CONTAINER CN110...	GR.	PACKAGING		UNIT PRICE €
					Qty. per pack.	Qty. per pallet	
1 CN CV12 4001	■			7000	1		
2 CN CV10 4001		■		1700	1		
3 CN CV11 4001			■	3100	1		
4 CN HAND480001		■			1		
4 CN HAND670001			■		1		

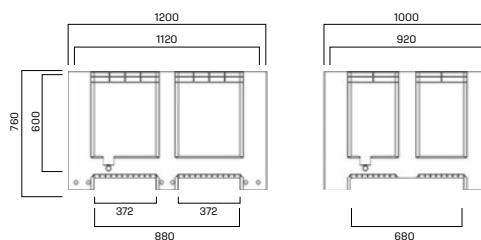

1

2



3



4



DATASHEET

A - CONTAINER COLLECTION OF USED BATTERIES WITH 3 CROSSBARS

Dimensions	1200 x 1000 x 760H mm
Internal dimensions	1120 x 920 x 600H mm
Load capacity	450 kg
Volume	610 litres
Pieces per pack / pallet	1 3

1 - LID FOR COLLECTION OF USED BATTERIES

Nominal dimensions	1200 x 1000 mm
Pieces per pack / pallet	1 3

2 - LID

Nominal dimensions	1000 x 640 mm
Pieces per pack / pallet	1 3

3 - LID

Nominal dimensions	1165 x 790
Pieces per pack / pallet	1 3

4 - TRANSPORT HANDLES

Length	480 mm/ 670 mm
Pieces per pack / pallet	1 3

iMilani srl reserves the right to alter the characteristics of products without notice. The values shown are nominal, with a +/- 1% tolerance for size, depending on the material, and a +/- 3% for weight.



iMICUBE
120



PALLET & LID

The pallet was invented over 80 years ago, in the form of a simple wooden structure to be placed under material to facilitate handling.

Since then, much progress has been made, not only as regards vehicles but also in materials and geometrical research to make pallets endlessly reusable, easy to wash and producible in sustainable materials.

For increased load retention and safety, goods placed on pallets can be protected with the use of lids, of thermoforming or injection moulding construction.

PALLET K SERIES

This is a pallet with a new-generation monolithic structure without seams or joints, designed to improve the entire logistics process. It facilitates mechanical and manual handling and has been tested to ISO 8611-1991 standards.

It has excellent resistance to falls and is highly tolerant to twisting and pressure exerted from top to bottom and vice versa.

Made of 100% recyclable black polypropylene. The grid support surface facilitates cleaning.

Can be customised with hot marking, barcodes and RFID.



iMiCUBE

121

PALLET J SERIES

Injection moulded pallet in High Density Polyethylene (HDPE) also suitable for food use, made of fully recyclable material, initial melting guarantee and certification.

Easy to clean and impervious to rust, insensitive to weight changes on contact with water.

Highly resistant to UV and infrared rays, high and low temperatures, acids and alkalis.

Can be customised with hot marking, barcodes and RFID.



PALLET M SERIES

Made from recycled polyethylene, fully environmentally-friendly.

The M Series pallets can be inserted one inside the other, thanks to their specially designed feet.

It is available for light and medium loads. The light-load model is nevertheless very durable and can also be used as a disposable pallet.

The honeycomb structure surface of the medium-load model makes it suitable also for intensive use.

Both versions can be customised with hot marking, barcodes and RFID.



LIDS

Available in 800x1200 mm and 1000x1200 mm sizes, they are made of high density polyethylene in the thermoforming version, which is lighter and more manageable, while polypropylene is used for the injection version.

Easily cleaned and reusable, they can be customised with hot marking, barcodes and RFID.



innovative
italian
ideas
iMilani

Dimensions

1200 x 800 mm
1200 x 1000 mm

	ARTICLE	ATHENA ATHENA LIGHT KRONOS	RL-KLT R-KLT	ODETTE	KG	PACKAGING		UNIT PRICE €
						Qty. per pack.	Qty. per pallet	
A	PA 1208EK 5107	■			17.3	1	15	
B	PA 1210IK 5107		■	■	17.9	1	15	

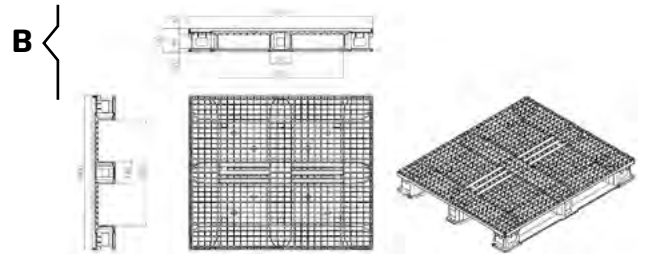
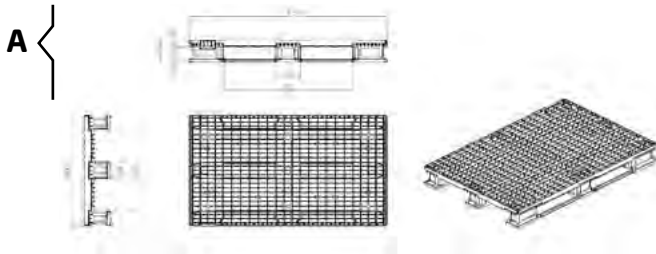

A - PALLET WITH FLUSH EDGE

Dimensions	1200 x 800 x 160H mm
Static load capacity	5000 kg
Dynamic load capacity	1500 kg
Pieces per pack / pallet	📦 1 🚚 15

B - PALLET WITH RIM

Dimensions	1200 x 1000 x 150H mm
Static load capacity	5000 kg
Dynamic load capacity	1500 kg
Pieces per pack / pallet	📦 1 🚚 15

DATASHEET

1200 x 800 mm
1200 x 1000 mm

ARTICLE	ATHENA ATHENA LIGHT KRONOS	RL-KLT R-KLT	ODETTE	KG	PACKAG- ING		UNIT PRICE €
					Qty. per pack.	Qty. per pallet	
D PA 1208FJ 5100			General use	12.3	1	15	
E PA 1210FJ 5100			General use	15.1	1	15	
F PA 1208HJ 5100		■	■	14.5	1	15	
G PA 1210HJ 5100		■	■	17.0	1	15	
H PA 1208LJ 5100	■			13.7	1	15	
I PA 1210LJ 5100	■			16.9	1	15	



D
E

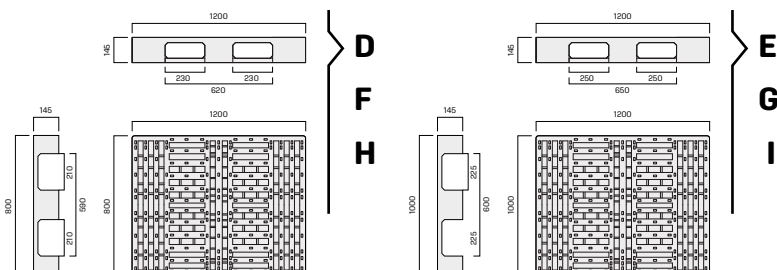

DATASHEET

D - PALLET WITHOUT RIM

Dimensions	1200 x 800 x 145H mm
Static load capacity	4000 kg
Dynamic load capacity	1500 kg
Pieces per pack / pallet	1 15

E - PALLET WITHOUT RIM

Dimensions	1200 x 1000 x 145H mm
Static load capacity	4000 kg
Dynamic load capacity	1500 kg
Pieces per pack / pallet	1 15

F - G PALLET WITH HIGH SECTION OUTER EDGE IN GALVANISED STEEL - FOR R-KLT RL-KLT - ODETTE

Dimensions	1200 x 800/1000 x 145H mm
Static load capacity	4000 kg
Dynamic load capacity	1500 kg
Pieces per pack / pallet	1 15

H - I PALLET WITH LOW SECTION OUTER EDGE IN GALVANISED STEEL - FOR ATHENA - ATHENA LIGHT - KRONOS

Dimensions	1200 x 800/1000 x 145H mm
Static load capacity	4000 kg
Dynamic load capacity	1500 kg
Pieces per pack / pallet	1 15



F
G



H
I

iMilani srl reserves the right to alter the characteristics of products without notice. The values shown are nominal, with a +/- 1% tolerance for size, depending on the material, and a +/- 3% for weight.

1200 x 800 mm
1200 x 1000 mm

	ARTICLE	NESTABLE	HEXAGONAL MESH	SQUARE MESH	KG	PACKAGING		UNIT PRICE €
						Qty. per pack.	Qty. per pallet	
A	PA 1208LM 5107	■		■	4.8	1	66	
B	PA 1210LM 5107	■		■	6.9	1	60	

Raw materials: Regenerated High Density Polyethylene

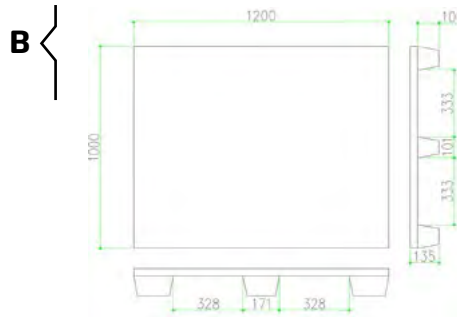
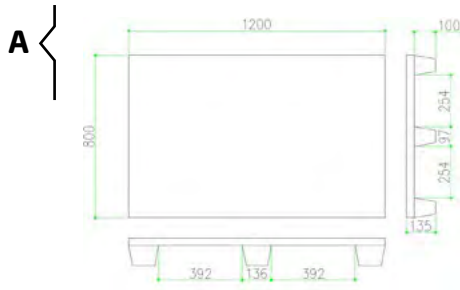

A	
Dimensions	1200 x 800 x 135H mm
Static load capacity	1500 kg
Dynamic load capacity	600 kg
Pieces per pack / pallet	📦 1 🚚 66

B	
Dimensions	1200 x 1000 x 135H mm
Static load capacity	1500 kg
Dynamic load capacity	600 kg
Pieces per pack / pallet	📦 1 🚚 60

DATASHEET

800 x 600 mm
 1200 x 800 mm
 1200 x 1000 mm

	ARTICLE	NESTABLE	HEXAGONAL MESH	SQUARE MESH	KG	PACKAGING		UNIT PRICE €
						Qty. per pack.	Qty. per pallet	
C	PA 0806AM 5107	■	■		3.2	1	60	
D	PA 1208AM 5107	■	■		8.1	1	55	
E	PA 1210AM 5107	■	■		9.25	1	60	



Raw materials: Regenerated High Density Polyethylene

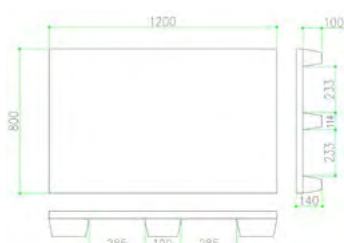
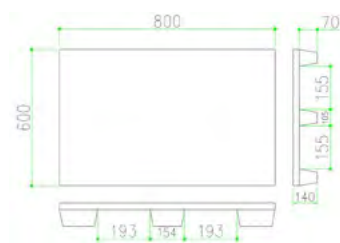
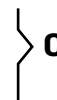

DATASHEET

C

Dimensions	800 x 600 x 140H mm
Static load capacity	3000 kg
Dynamic load capacity	600 kg
Pieces per pack / pallet	📦 1 🚚 60

D

Dimensions	1200 x 800 x 140H mm
Static load capacity	4000 kg
Dynamic load capacity	1200 kg
Pieces per pack / pallet	📦 1 🚚 55

E



Dimensions	1200 x 1000 x 140H mm
Static load capacity	4000 kg
Dynamic load capacity	1200 kg
Pieces per pack / pallet	📦 1 🚚 60



iMilani srl reserves the right to alter the characteristics of products without notice. The values shown are nominal, with a +/- 1% tolerance for size, depending on the material, and a +/- 3% for weight.

Dimensions



1200 x 800 mm
1200 x 1000 mm

	ARTICLE	THERMOFORMING	INJECTION	GR	PACKAGING		UNIT PRICE €
					Qty. per pack.	Qty. per pallet	
 A	CV 1208C3 5107	■		4275	1	50	
 B	CV 1210C3 5107	■		4980	1	141	





 THERMOFORMED LIDS

A

Nominal dimensions	1200 x 800 mm
Height space when in use	40 mm
Pieces per pack / pallet	 1  50
Pallet dimensions	1250 x 850 x 1050H mm

B

Nominal dimensions	1200 x 1000 mm
Height space when in use	40 mm
Pieces per pack / pallet	 1  141
Pallet dimensions	1230 x 1035 x 1170H mm

DATASHEET

1200 x 800 mm
1200 x 1000 mm

	ARTICLE	THERMOFORMING	INJECTION	GR	PACKAGING		UNIT PRICE €
					Qty. per pack.	Qty. per pallet	
C	CV 1208SC 5107		■	5770	1	20	
D	CV 1210SH 5107		■	7390	1	20	



DATASHEET

C

Nominal dimensions	1200 x 800 mm
Height space when in use	20 mm
Pieces per pack / pallet	📦 1 🚚 20
Pallet dimensions	1250 x 850 x 960H mm

D - LID FOR USE SPECIFICALLY WITH R-KLT / RL-KLT / ODETTE

Nominal dimensions	1200 x 1000 mm
Height space when in use	20 mm
Pieces per pack / pallet	📦 1 🚚 20
Pallet dimensions	1250 x 850 x 960H mm

📄 LID OF INJECTION MANUFACTURE

SPACE SAVER

128

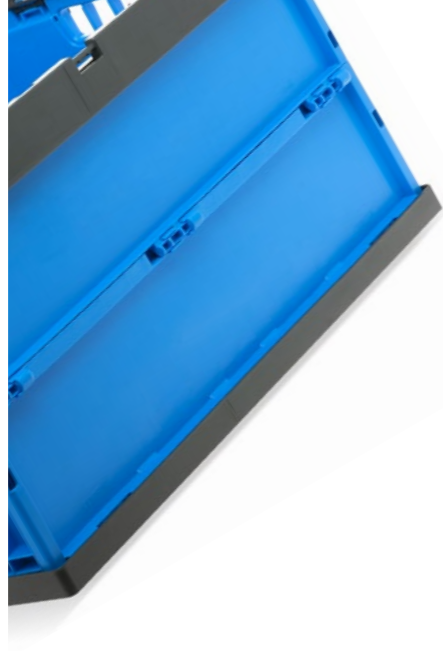

KRONOS

130



136

DELTA

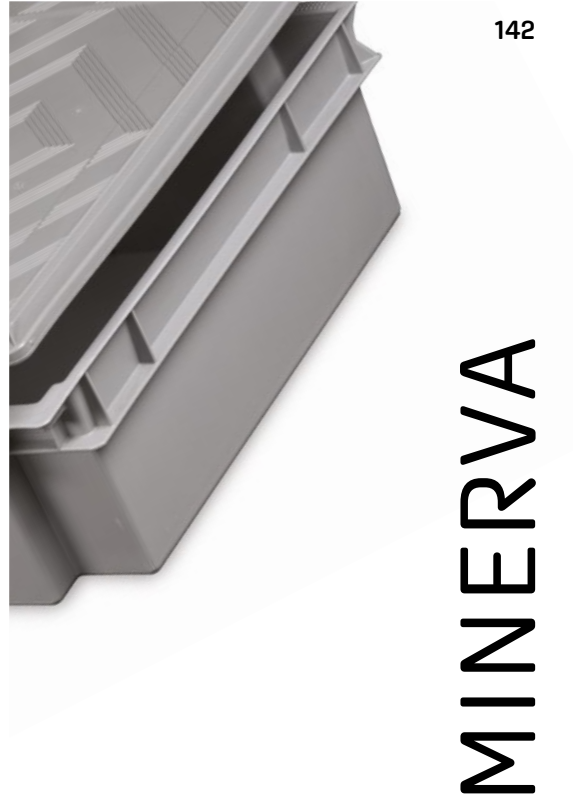

142

MINERVA

iMiCUBE
130



KRONOS

KRONOS foldable boxes have been designed and manufactured to significantly reduce the overall space occupied when not in use and during transport of empties. Their volume reduction of up to 75% therefore leads to high savings in storage and transport costs. KRONOS foldable boxes are equipped with a sturdy stacking edge and ribbed outer walls at the highest stress points: these structural features give the boxes extra durability over time.

Lightweight and manageable, they adapt perfectly to normalised pallets. Their flat bottoms allow use on all types of roller beds, thus giving great flexibility also in internal handling.

The short sides are supplied with handy label holders and comfort handles for easy grip; the handles can be closed with the use of special casings.

WALLS



handle closure casing



When used with the lid, the box can be fastened shut with disposable seals that are also customisable: the seals are applied on the two-flap lid and on the opening mechanism positioned on the two short sides of the box.

iMiCUBE

131

FOLDABILITY

400 x 300 x 220H mm



600 x 400 x 220H mm

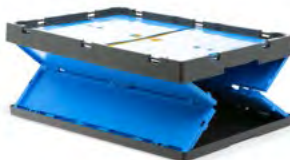

600 x 400 x 320H mm





400 x 300 mm H 220 mm

ARTICLE	WALLS		BOTTOM			HANDLES		GR.	PACKAGING		UNIT PRICE €
	Closed	Perforated	Closed	Perforated	Reinforced	Closed	Open		Qty. per pack.	Qty. per pallet	
B KR 4322B 51XB	■		■			■		1510	10	240	
ACCESSORIES											
1 KR 43HG 51XB								277	5	700	
2 KR PLUG 5125								18	10		
3 KR SEAL 5113									500		



iMilani
133



B

Closed bottom
Load capacity 20 kg



1



2



3



DATASHEET

B	
Height closed	80 mm
Stacked edge height closed	72 mm
Stacked edge height open	212 mm
Usable stacked height / with lid	202 mm / 202 mm
Usable internal dimensions	354 x 256 x 216H mm
Maximum stacking load capacity	160 kg
Volume	20 litres
Pieces per pack / pallet	📦 10 🚚 240
Package dimensions	620 x 420 x 388H mm
Pallet dimensions	1200 x 800 x 2318H mm
1	
Lid	400 x 300 mm
Pieces per pack. / dimension	📦 5 / 410 x 180 x 150H mm
Pieces per pallet / dimension	🚚 700 / 1200 x 800 x 870H mm
2	
Handle closure casing	
Pieces per pack	📦 10
3	
Disposable security seal	
Pieces per pack	📦 500

THE LIDS ARE SUPPLIED SEPARATELY

iMilani srl reserves the right to alter the characteristics of products without notice. The values shown are nominal, with a +/- 1% tolerance for size, depending on the material, and a +/- 3% for weight.

B

Closed bottom
Load capacity 20 kg



1



2



3



Dimensions

600 x 400 mm H 220 mm

ARTICLE	WALLS		BOTTOM			HANDLES		GR.	PACKAGING		UNIT PRICE €
	Closed	Perforated	Closed	Perforated	Reinforced	Closed	Open		Qty. per pack.	Qty. per pallet	
B KR 6422B 51XB	■		■			■		2192	5	120	
ACCESSORIES											
1 KR 64HG 51XB								590	5	350	
2 KR PLUG 5125								18	10		
3 KR SEAL 5113									500		

B

Height closed	80 mm
Stacked edge height closed	72 mm
Stacked edge height open	212 mm
Usable stacked height / with lid	202 mm/ 202 mm
Usable internal dimensions	554 x 356 x 216H mm
Maximum stacking load capacity	160 kg
Volume	40 litres
Pieces per pack / pallet	5 120
Package dimensions	620 x 420 x 388H mm
Pallet dimensions	1200 x 800 x 2318H mm

1

Lid	600 x 400 mm
Pieces per pack. / dimension	5 / 610 x 250 x 150H mm
Pieces per pallet / dimension	350 / 1200 x 800 x 870H mm

2

Handle closure casing	
Pieces per pack	10

3

Disposable security seal	
Pieces per pack	500

THE LIDS ARE SUPPLIED SEPARATELY

DATASHEET

600 x 400 mm H 320 mm

	ARTICLE	WALLS		BOTTOM			HANDLES		GR.	PACKAGING		UNIT PRICE €
		Closed	Perforated	Closed	Perforated	Reinforced	Closed	Open		Qty. per pack.	Qty. per pallet	
B	KR 6432B 51XB	■		■			■		2780	5	120	
ACCESSORIES												
1	KR 64HG 51XB								590	5	350	
2	KR PLUG 5125								18	10		
3	KR SEAL 5113									500		



iMiCUBE
135



B
Closed bottom
Load capacity 20 kg



1



2



3

DATASHEET

B	
Height closed	80 mm
Stacked edge height closed	72 mm
Stacked edge height open	312 mm
Usable stacked height / with lid	302 mm / 302 mm
Usable internal dimensions	554 x 356 x 316H mm
Maximum stacking load capacity	160 kg
Volume	60 litres
Pieces per pack / pallet	📦 5 🚚 120
Package dimensions	620 x 420 x 388H mm
Pallet dimensions	1200 x 800 x 2318H mm
1	
Lid	600 x 400 mm
Pieces per pack. / dimension	📦 5 / 610 x 250 x 150H mm
Pieces per pallet / dimension	🚚 350 / 1200 x 800 x 870H mm
2	
Handle closure casing	
Pieces per pack	📦 10
3	
Disposable security seal	
Pieces per pack	📦 500

THE LIDS ARE SUPPLIED SEPARATELY

iMilani srl reserves the right to alter the characteristics of products without notice. The values shown are nominal, with a +/- 1% tolerance for size, depending on the material, and a +/- 3% for weight.



iMiCUBE
136



DELTA

Boxes in the Delta series have a truncated cone structure, allowing for stable and safe stacking at full load. When empty they can be inserted one inside the other, resulting in a 70% reduction in volume.

These properties make them perfect for maximising warehouse space and transport space. They are particularly useful in shipment returns when empty or when packaging must take up the least possible space.

SAFETY



With the separate or hinged two-flap lids, the box can be fastened shut with dedicated disposable seals as well with commercially available nylon ties.

In addition to these, straps can be used both on the short and long sides, with containment points provided to prevent unauthorised removal of the straps.

iMiCUBE

137

STACKING



By shifting the pair of yellow supports towards the inside or the outside, the boxes can be stacked and interlocked.



In the version with the two-flap lid, you can stack the boxes and interlock them. Stacking with the lids open ensures geometrical consistency of the battery of boxes.

TRANSPORT

The wedges on the edges of short sides ensure the stability of the box in the event of accidental interruptions during the advance of automatic rollers and conveyor belts.

The external surface of the bottom has a smooth frame and rounded edge, for a silent impact on conveyor system rollers. Additionally, the surface of the central part is designed for increased adherence, ideal for safe transport over flat surfaces and conveyor belt ramps in ascent and descent.

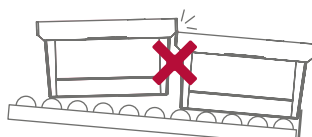



600 x 400 mm H 225 mm
600 x 400 mm H 230 mm
600 x 400 mm H 240 mm

Version A

Version I

Version Z

	ARTICLE	BOTTOM WALLS HANDLES	SUPPORTS FOR STACKING	HINGED LID	GR.	PACKAGING		UNIT PRICE €
						Qty. per pack	Qty. per pallet	
A	DE 6422A 5101	■			1706	5	136	
	DE 6422A 51XB	■			1706	5	136	
I	DE 6422I 5101	■	■		1922	5	136	
	DE 6422I 51XB	■	■		1922	5	136	
Z	DE 6422Z 5101	■		■	2606	5	104	
	DE 6422Z 51XB	■		■	2606	5	104	
ACCESSORIES								
1	DE 64SE 5101				960	1	160	
	DE 64SE 51XB				960	1	160	
2	DE SEAL 5113					500		
ARTICLE ON REQUEST								
A	DE 6422A 5900	■			1706	5	136	
I	DE 6422I 5900	■	■		1922	5	136	
Z	DE 6422Z 5900	■		■	2606	5	104	
1	DE 64SE 5900				960	1	160	



iMiCUBE
139

Closed bottom load capacity 20 kg



I

Closed bottom Load capacity 20 kg



Z

Closed bottom Load capacity 20 kg



1



2

DATASHEET

A - I

Stacked edge height	50 mm
Usable height with lid	215 mm
Usable internal dimensions at the base	500 x 330 x 220H mm
Volume	38 litres
Pieces per pack / pallet	5 / 136
Package dimensions	620 x 420 x 445H mm
Pallet dimensions	1220 x 800 x 2025H mm

Z

Stacked edge height	90 mm
Usable height with lid	215 mm
Usable internal dimensions at the base	500 x 330 x 220H mm
Volume	38 litres
Pieces per pack / pallet	5 / 104
Package dimensions	630 x 510 x 520H mm
Pallet dimensions	1300 x 1000 x 2015H mm

1

Lid nominal measurement	600 x 400 mm
Pieces per pack. / dimension	1 / 610 x 410 x 30H mm
Pieces per pallet / dimension	160 / 1220 x 800 x 1000H mm

2

Disposable security seal	
Pieces per pack	500

ARTICLES ON REQUEST

Minimum order200 boxes
 Delivery guaranteed within.....6 weeks

iMilani srl reserves the right to alter the characteristics of products without notice. The values shown are nominal, with a +/- 1% tolerance for size, depending on the material, and a +/- 3% for weight.

Closed bottom
Load capacity 20 kg



A



Closed bottom
Load capacity 20 kg



I



Closed bottom
Load capacity 20 kg



Z



1



2



Dimensions

Version A	600 x 400 mm H 325 mm
Version I	600 x 400 mm H 330 mm
Version Z	600 x 400 mm H 340 mm

	ARTICLE	BOTTOM WALLS HANDLES	SUPPORTS FOR STACKING	HINGED LID	GR.	PACKAGING		UNIT PRICE €
						Qty. per pack	Qty. per pallet	
		Closed						
A	DE 6432A 5101	■			2270	4	80	
	DE 6432A 51XB	■			2270	4	80	
I	DE 6432I 5101	■	■		2486	4	80	
	DE 6432I 51XB	■	■		2486	4	80	
Z	DE 6432Z 5101	■		■	3170	4	76	
	DE 6432Z 51XB	■		■	3170	4	76	
ACCESSORIES								
1	DE 64SE 5101				960	1	160	
	DE 64SE 51XB				960	1	160	
2	DE SEAL 5113					500		
ARTICLE ON REQUEST								
A	DE 6432A 5900	■			2270	4	80	
I	DE 6432I 5900	■	■		2486	4	80	
Z	DE 6432Z 5900	■		■	3170	4	76	
1	DE 64SE 5900				960	1	160	

A - I

Stacked edge height	80 mm
Usable height with lid	315 mm
Usable internal dimensions at the base	500 x 330 x 320H mm
Volume	58 litres
Pieces per pack / pallet	4 80
Package dimensions	620 x 420 x 585H mm
Pallet dimensions	1220 x 800 x 1995H mm

Z

Stacked edge height	120 mm
Usable H.	315 mm
Usable internal dimensions at the base	500 x 330 x 320H mm
Volume	58 litres
Pieces per pack / pallet	4 76
Package dimensions	630 x 510 x 645H mm
Pallet dimensions	1300 x 1000 x 2200H mm

1

Lid nominal measurement	600 x 400 mm
Pieces per pack. / dimension	1 / 610 x 410 x 30H mm
Pieces per pallet / dimension	160 / 1220 x 800 x 1000H mm

2

Disposable security seal	
Pieces per pack	500

ARTICLES ON REQUEST

Minimum order200 boxes
Delivery guaranteed within.....6 weeks

600 x 400 mm H 425 mm Version A
 600 x 400 mm H 430 mm Version I
 600 x 400 mm H 440 mm Version Z

	ARTICLE	BOTTOM WALLS HANDLES	SUPPORTS FOR STACKING	HINGED LID	GR.	PACKAGING		UNIT PRICE €
						Qty. per pack	Qty. per pallet	
A	DE 6442A 5101	■			2890	3	64	♻️ PP
	DE 6442A 51XB	■			2890	3	64	
I	DE 6442I 5101	■	■		3106	3	64	♻️ PP
	DE 6442I 51XB	■	■		3106	3	64	
Z	DE 6442Z 5101	■		■	3790	3	56	♻️ PP
	DE 6442Z 51XB	■		■	3790	3	56	
ACCESSORIES								
1	DE 64SE 5101				960	1	160	♻️ PP
	DE 64SE 51XB				960	1	160	
2	DE SEAL 5113					500		♻️ PP
ARTICLE ON REQUEST								
A	DE 6442A 5900	■			2890	3	64	♻️ ♻️
I	DE 6442I 5900	■	■		3106	3	64	♻️ ♻️
Z	DE 6442Z 5900	■		■	3790	3	56	♻️ ♻️
1	DE 64SE 5900				960	1	160	♻️ ♻️

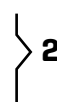
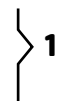
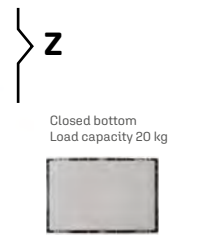
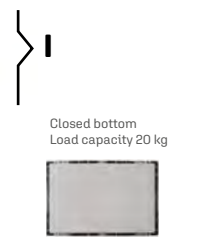
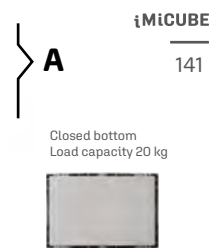

DATASHEET

A - I	
Stacked edge height	100 mm
Usable height with lid	415 mm
Usable internal dimensions at the base	500 x 330 x 420H mm
Volume	74 litres
Pieces per pack / pallet	3 64
Package dimensions	620 x 420 x 605H mm
Pallet dimensions	1220 x 800 x 2075H mm
Z	
Stacked edge height	140 mm
Usable height with lid	415 mm
Usable internal dimensions at the base	500 x 330 x 420H mm
Volume	74 litres
Pieces per pack / pallet	3 56
Package dimensions	630 x 510 x 650H mm
Pallet dimensions	1300 x 1000 x 2085H mm
1	
Lid nominal measurement	600 x 400 mm
Pieces per pack. / dimension	1 / 610 x 410 x 30H mm
Pieces per pallet / dimension	160 / 1220 x 800 x 1000H mm
2	
Disposable security seal	
Pieces per pack	500

ARTICLES ON REQUEST

Minimum order200 boxes
 Delivery guaranteed within.....6 weeks

iMilani srl reserves the right to alter the characteristics of products without notice. The values shown are nominal, with a +/- 1% tolerance for size, depending on the material, and a +/- 3% for weight.

iMiCUBE
142



MINERVA

Boxes in the MINERVA series have a truncated cone structure, allowing for stable and safe stacking at full load. When empty they can be inserted one inside the other, resulting in a 60% reduction in volume.

These properties make them perfect for maximising warehouse space and transport space. They are particularly useful in shipment returns when empty or when packaging must take up the least possible space.

HANDLES

open handle



WALLS

closed walls



perforated walls



BOTTOMS

closed bottom



perforated bottom



iMiCUBE

143

The Minerva series boxes have asymmetrical wall geometry. This characteristic means that, without having to use the lid, you can create a stack when they are empty, or when they are full by simply rotating the box by 180°; they can thus be nested when empty or stacked when full.

When the separate lid is used, however, stacking of the full box does not require any rotation.

Boxes stacked with lid



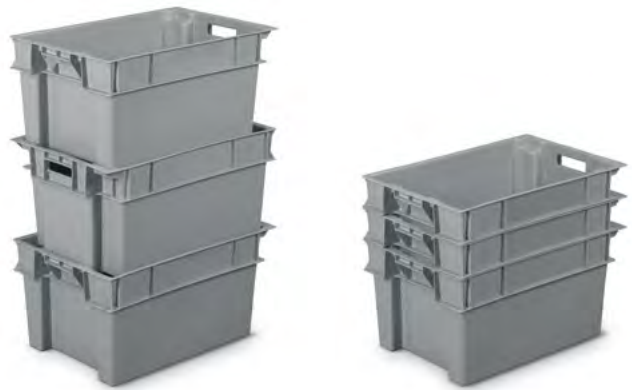

Boxes stacked without lid





600 x 400 mm H 200 mm

	ARTICLE	WALLS		BOTTOM			HANDLES		GR.	PACKAGING		UNIT PRICE €
		Closed	Perforated	Closed	Perforated	Reinforced	Closed	Open		Qty. per pack.	Qty. per pallet	
B	MI 6420B 5101	■		■			■		1650	6	128	
	MI 6420B 51XB	■		■			■		1650	6	128	
	MI 6420B 5900	■		■			■		1650	6	128	
S	MI 6420S 5101		■		■		■		1502	6	128	
	MI 6420S 51XB		■		■		■		1502	6	128	
	MI 6420S 5900		■		■		■		1502	6	128	
ACCESSORIES												
1	MI 64SE 5101								1000	1	160	
	MI 64SE 51XB								1000	1	160	
	MI 64SE 5900								1000	1	160	
2	SPRING 0099									10		
3	MI LOCK 0099									10		



Closed bottom
Load capacity 20 kg



Perforated bottom
Load capacity 20 kg



1



2



3

iMiCUBE
145

MINERVA 6420

DATASHEET

B - S	
Stacked edge height	60 mm
Usable stacked height / with lid	178 mm/ 195 mm
Usable internal dimensions	453 x 336 x 197H mm
Volume	32 litres
Pieces per pack / pallet	📦 6 🚚 128
Package dimensions	620 x 420 x 520H mm
Pallet dimensions	1200 x 800 x 2210H mm
1	
Lid nominal measurement	600 x 400 mm
Pieces per pack. / dimension	📦 1 / 610 x 410 x 30H mm
Pieces per pack. / dimension	🚚 160 / 1230 x 820 x 950H mm
2	
Labels and document holder spring	
Pieces per pack	📦 10
3	
Lid holder spring	
Pieces per pack	📦 10

iMilani srl reserves the right to alter the characteristics of products without notice. The values shown are nominal, with a +/- 1% tolerance for size, depending on the material, and a +/- 3% for weight.

Closed bottom
Load capacity 20 kg



B



S

Perforated bottom
Load capacity 20 kg



1



2



3



ARTICLE	WALLS		BOTTOM			HANDLES		GR.	PACKAGING		UNIT PRICE €
	Closed	Perforated	Closed	Perforated	Reinforced	Closed	Open		Qty. per pack.	Qty. per pallet	
MI 6430B 5101	■		■				■	2432	4	88	
MI 6430B 51XB	■		■				■	2432	4	88	
MI 6430B 5900	■		■				■	2432	4	88	
MI 6430S 5101		■		■			■	2294	4	88	
MI 6430S 51XB		■		■			■	2294	4	88	
MI 6430S 5900		■		■			■	2294	4	88	
ACCESSORIES											
MI 64SE 5101								1000	1	160	
MI 64SE 51XB								1000	1	160	
MI 64SE 5900								1000	1	160	
2 SPRING 0099									10		
3 MI LOCK 0099									10		

B - S

Stacked edge height	86 mm
Usable stacked height / with lid	272 mm/ 295 mm
Usable internal dimensions	453 x 336 x 297H mm
Volume	50 litres
Pieces per pack / pallet	📦 4 🚚 88
Package dimensions	620 x 420 x 578H mm
Pallet dimensions	1200 x 800 x 2256H mm

1

Lid nominal measurement	600 x 400 mm
Pieces per pack. / dimension	📦 1 / 610 x 410 x 30H mm
Pieces per pack. / dimension	🚚 160 / 1230 x 820 x 950H mm

2

Labels and document holder spring	
Pieces per pack	📦 10

3

Lid holder spring	
Pieces per pack	📦 10

600 x 400 mm H 400 mm

	ARTICLE	WALLS		BOTTOM			HANDLES		GR.	PACKAGING		UNIT PRICE €
		Closed	Perforated	Closed	Perforated	Reinforced	Closed	Open		Qty. per pack.	Qty. per pallet	
B	MI 6440B 5101	■		■			■		2865	3	60	
	MI 6440B 51XB	■		■			■		2865	3	60	
	MI 6440B 5900	■		■			■		2865	3	60	
S	MI 6440S 5101		■		■		■		2654	3	60	
	MI 6440S 51XB		■		■		■		2654	3	60	
	MI 6440S 5900		■		■		■		2654	3	60	
ACCESSORIES												
1	MI 64SE 5101								1000	1	160	
	MI 64SE 51XB								1000	1	160	
	MI 64SE 5900								1000	1	160	
2	SPRING 0099									10		
3	MI LOCK 0099									10		



B
iMiCUBE
147

Closed bottom
Load capacity 20 kg



S

Perforated bottom
Load capacity 20 kg

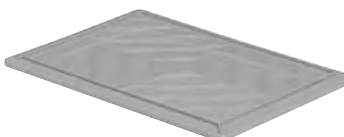

1



2



3

DATASHEET

B - S	
Stacked edge height	117 mm
Usable stacked height / with lid	372 mm/ 395 mm
Usable internal dimensions	453 x 336 x 397H mm
Volume	70 litres
Pieces per pack / pallet	📦 3 🚚 60
Package dimensions	620 x 420 x 520H mm
Pallet dimensions	1200 x 800 x 2210H mm
1	
Lid nominal measurement	600 x 400 mm
Pieces per pack. / dimension	📦 1 / 610 x 410 x 30H mm
Pieces per pack. / dimension	🚚 160 / 1230 x 820 x 950H mm
2	
Labels and document holder spring	
Pieces per pack	📦 10
3	
Lid holder spring	
Pieces per pack	📦 10

iMilani srl reserves the right to alter the characteristics of products without notice. The values shown are nominal, with a +/- 1% tolerance for size, depending on the material, and a +/- 3% for weight.

C-PARTS

148





RK

180



ZEUS

202

iMiCUBE
150



COMPAT

The Compat container series is the ideal solution to any storage problems in the warehouse, workshop or on assembly lines. They allow you to have the contents always at hand and in full view, making them easily extractable.

These containers can be stacked stably and safely and the material is just as easily accessible even when they are one on top of the other.

BOTTOMS

smooth bottom



ribbed bottom



bottom ribbed at 45° with crossbar

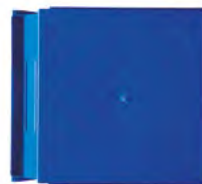

iMiCUBE

151

CROSSBAR



The largest containers are equipped with a frontal crossbar that helps prevent any deformation of the side walls due to large loads and to facilitate grip.

HANDLES



Lifting and transport are aided by convenient handles that allow for quick grip even with gloves.

SIDE REINFORCEMENT



Lateral reinforcement on the bottom allows the containers to be stacked safely even when fully loaded.

ACCESSORIES













The containers can be divided longitudinally and transversely for load units with multiple products inside them.





Practical transparent doors protect against dust.

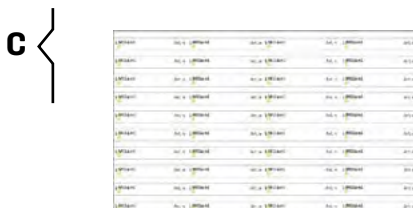
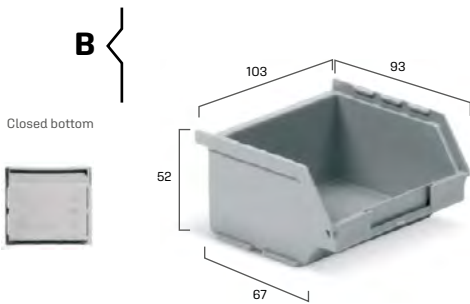
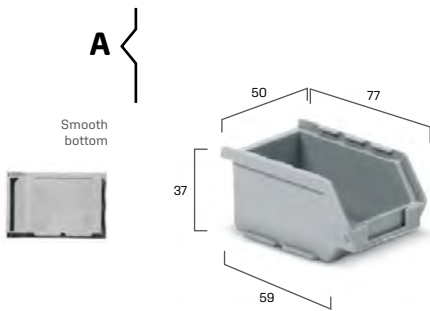

Internal partition with removable boxes

ARTICLE	SMOOTH BOTTOM	SIZE 01	SIZE 0	GR.	PACKAGING		UNIT PRICE €
					Qty. per pack.	Qty. per pallet	
	Closed						
 CO Z001 5101	■	■		18	100	-	
 CO Z001 5102	■	■		18	100	-	
A  CO Z001 5103	■	■		18	100	-	
 CO Z001 5104	■	■		18	100	-	
 CO Z001 5105	■	■		18	100	-	
 CO Z000 5101	■		■	38	98	-	
 CO Z000 5102	■		■	38	98	-	
B  CO Z000 5103	■		■	38	98	-	
 CO Z000 5104	■		■	38	98	-	
 CO Z000 5105	■		■	38	98	-	
 CO Z000 5207	■		■	43	98	-	
C LB 4911 8001	■		■		1		



A	
Volume	0.08 litres
Pieces per pack	 100
Package dimensions	350 x 270 x 170H mm
B	
Volume	0.25 litres
Pieces per pack	 98
Package dimensions	470 x 300 x 350H mm
C	
Sheet of 80 labels for size 0	49 x 11H mm

DATASHEET

Size 1 - Size 2

ARTICLE	SMOOTH BOTTOM	SIZE 1	SIZE 2	GR.	PACKAGING		UNIT PRICE €
					Qty. per pack.	Qty. per pallet	
CO C001 5101	■	■		78	50	1750	
CO C001 5102	■	■		78	50	1750	
CO C001 5103	■	■		78	50	1750	
A CO C001 5104	■	■		78	50	1750	
CO C001 5105	■	■		78	50	1750	
CO C001 5401	■	■		82	50	1750	
CO C001 5207	■	■		87	50	1750	
CO C002 5101	■		■	214	54	1080	
CO C002 5102	■		■	214	54	1080	
CO C002 5103	■		■	214	54	1080	
B CO C002 5104	■		■	214	54	1080	
CO C002 5105	■		■	214	54	1080	
CO C002 5207	■		■	240	54	1080	
CO C002 5401	■		■	224	54	1080	ECOGREEN
CO C1S2 5407		■		40	25	-	ECOGREEN
CO C1S2 5207		■		45	25	-	
CO C2S2 5407			■	100	25	-	ECOGREEN
CO C2S2 5207			■	112	25	-	
CO C1S4 5407		■		50	25	-	ECOGREEN
D CO C1S4 5207		■		56	25	-	
CO C2S4 5407			■	120	25	-	ECOGREEN
CO C2S4 5207			■	134	25	-	
E LB 7520 3601		■			1		
LB 10433 1601			■		1		

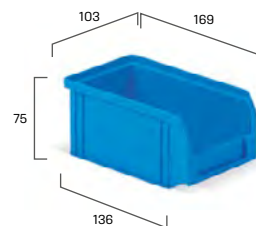

A iMiCUBE 153

Closed bottom
Load capacity 2 kg

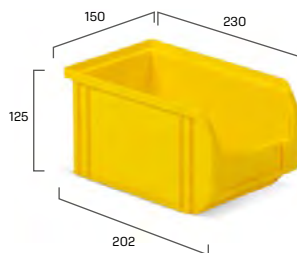

B

Closed bottom
Load capacity 5 kg



C



D



LB 7520 3601	LB 10433 1601	LB 7520 3601	LB 10433 1601
LB 7520 3601	LB 10433 1601	LB 7520 3601	LB 10433 1601
LB 7520 3601	LB 10433 1601	LB 7520 3601	LB 10433 1601
LB 7520 3601	LB 10433 1601	LB 7520 3601	LB 10433 1601
LB 7520 3601	LB 10433 1601	LB 7520 3601	LB 10433 1601
LB 7520 3601	LB 10433 1601	LB 7520 3601	LB 10433 1601
LB 7520 3601	LB 10433 1601	LB 7520 3601	LB 10433 1601
LB 7520 3601	LB 10433 1601	LB 7520 3601	LB 10433 1601
LB 7520 3601	LB 10433 1601	LB 7520 3601	LB 10433 1601
LB 7520 3601	LB 10433 1601	LB 7520 3601	LB 10433 1601

E

DATASHEET

A	
Volume	1 litre
Pieces per pack / pallet	50 1750
Package dimensions	520 x 350 x 370H mm
Pallet dimensions	1300 x 1000 x 2000H mm
B	
Volume	3.8 litre
Pieces per pack / pallet	54 1080
Package dimensions	720 x 460 x 500H mm
Pallet dimensions	1450 x 1200 x 2100H mm
C	
Divider 2 compartments for size 1	
Divider 2 compartments for size 2	
D	
Divider 4 compartments for size 1	
Divider 4 compartments for size 2	
E	
Sheet of 36 labels for size 1	75 x 20H mm
Sheet of 16 labels for size 2	104 x 33H mm

iMilani srl reserves the right to alter the characteristics of products without notice. The values shown are nominal, with a +/- 1% tolerance for size, depending on the material, and a +/- 3% for weight.

ARTICLE	RIBBED BOTTOM	SIZE 3A2	SIZE 3	SIZE 3L5	GR.	PACKAGING		UNIT PRICE €
						Qty. per pack.	Qty. per pallet	
CO C3A2 5101	■	■			598	21	252	
CO C3A2 5102	■	■			598	21	252	
CO C3A2 5103	■	■			598	21	252	
A CO C3A2 5104	■	■			598	21	252	
CO C3A2 5105	■	■			598	21	252	
ECOGREEN CO C3A2 5401	■	■			625	21	252	
CO C3A2 5207	■	■			670	21	252	
CO C003 5101	■		■		784	15	180	
CO C003 5102	■		■		784	15	180	
CO C003 5103	■		■		784	15	180	
B CO C003 5104	■		■		784	15	180	
CO C003 5105	■		■		784	15	180	
ECOGREEN CO C003 5401	■		■		819	15	180	
CO C003 5207	■		■		878	15	180	
CO Z3L5 5101	■			■	1074	14	112	
CO Z3L5 5102	■			■	1074	14	112	
C CO Z3L5 5103	■			■	1074	14	112	
CO Z3L5 5104	■			■	1074	14	112	
CO Z3L5 5105	■			■	1074	14	112	

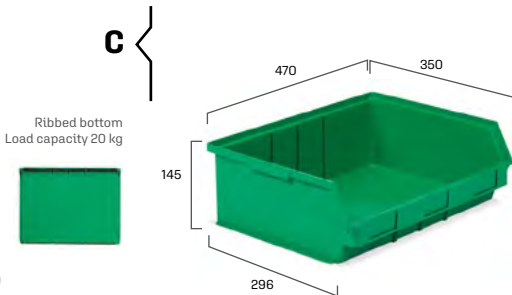
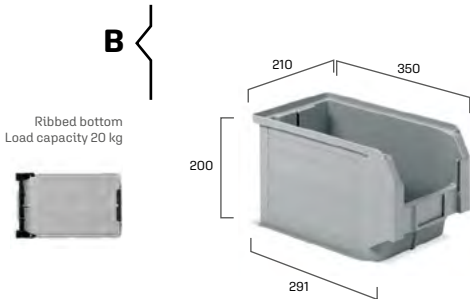
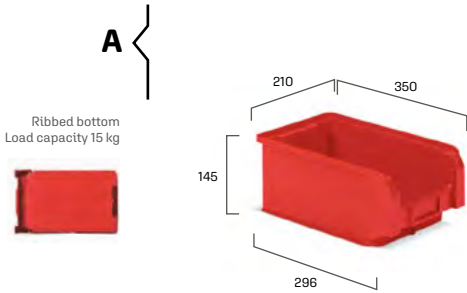

A	
Volume	9.4 litres
Pieces per pack / pallet	21 252
Package dimensions	360 x 640 x 980H mm
Pallet dimensions	1300 x 1000 x 2000H mm
B	
Volume	12.5 litres
Pieces per pack / pallet	15 180
Package dimensions	360 x 640 x 980H mm
Pallet dimensions	1300 x 1000 x 2000H mm
C	
Volume	19 litres
Pieces per pack / pallet	14 112
Package dimensions	710 x 960 x 480H mm
Pallet dimensions	1450 x 1000 x 2100H mm

Size 3A2 - Size 3 - Size 3L5

	ARTICLE	SIZE 3A2	SIZE 3	SIZE 3L5	GR.	PACKAGING		UNIT PRICE €
						Qty. per pack.	Qty. per pallet	
A	CD C3A2 0099	■			200	1		
	CD C003 0099		■		300	1		
	CD Z3L5 0099			■	250	1		
B	CD C3A2 7107	■			108	10		
	CD C003 7107		■		160	10		
	CD Z3L5 7107			■	114	10		
C	CW C3A2 6896	■			28	10		
	CW C003 6896		■		40	10		
D	LH C000 0099	■	■		100	1		
E	LB 7731 1801	■		■		1		
	LB 7742 1201		■			1		



A



B



C



D

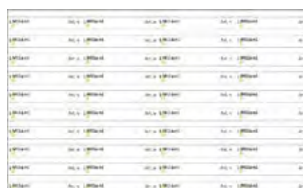

E

DATASHEET

A	
Galvanised longit. divider size 3A2	302 x 105H mm
Galvanised longit. divider size 3	307 x 160H mm
Galvanised longit. divider size 3L5	326 x 115H mm
Pieces per pack	📦 1
B	
Plastic longit. divider size 3A2	300 x 105H mm
Plastic longit. divider size 3	305 x 160H mm
Plastic longit. divider size 3L5	325 x 105H mm
Pieces per pack	📦 10
C	
Dust cover size 3A2	
Dust cover size 3	
Pieces per pack	📦 10
D	
Inclined galvanised tag holder for size 3 - 3A2	100 x 67 mm
Pieces per pack	1
E	
Sheet of 18 labels for size 3A2 - 3L5	77 x 31 mm
Sheet of 12 labels for size 3	77 x 42 mm
Pieces per pack	📦 1

iMilani srl reserves the right to alter the characteristics of products without notice. The values shown are nominal, with a +/- 1% tolerance for size, depending on the material, and a +/- 3% for weight.

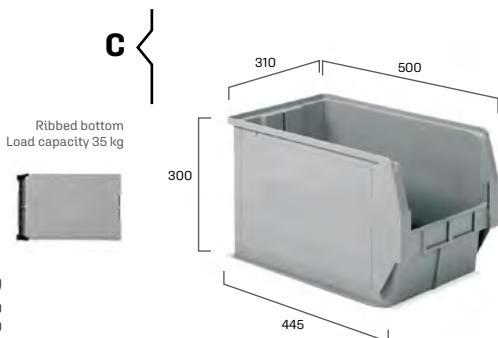
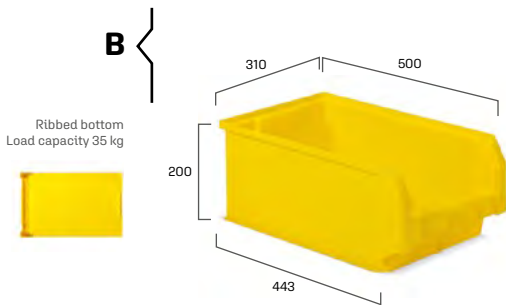
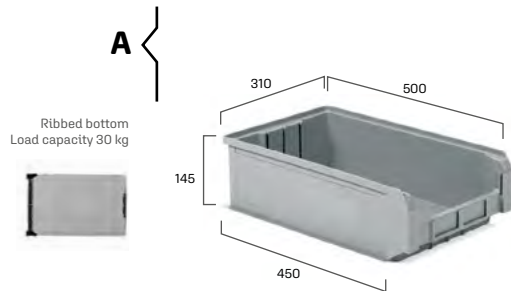

ARTICLE	RIBBED BOTTOM	SIZE 4A2	SIZE 4	SIZE 4A5	GR.	PACKAGING		UNIT PRICE €
						Qty. per pack.	Qty. per pallet	
CO C4A2 5101	■	■			1222	14	112	
CO C4A2 5102	■	■			1222	14	112	
A CO C4A2 5103	■	■			1222	14	112	
CO C4A2 5104	■	■			1222	14	112	
CO C4A2 5105	■	■			1222	14	112	
CO C004 5101	■		■		1335	10	80	
CO C004 5102	■		■		1335	10	80	
CO C004 5103	■		■		1335	10	80	
B CO C004 5104	■		■		1335	10	80	
CO C004 5105	■		■		1335	10	80	
ECOGREEN CO C004 5401	■		■		1395	10	80	
CO C004 5207	■		■		1495	10	80	
CO C4A5 5101	■			■	1874	6	48	
CO C4A5 5102	■			■	1874	6	48	
C CO C4A5 5103	■			■	1874	6	48	
CO C4A5 5104	■			■	1874	6	48	
CO C4A5 5105	■			■	1874	6	48	

A

Volume	20 litres
Pieces per pack / pallet	📦 14 🚚 112
Package dimensions	640 x 520 x 900H mm
Pallet dimensions	1300 x 1000 x 2150H mm

B

Volume	28 litres
Pieces per pack / pallet	📦 10 🚚 80
Package dimensions	640 x 520 x 980H mm
Pallet dimensions	1300 x 1000 x 2150H mm

C

Volume	42 litres
Pieces per pack / pallet	📦 6 🚚 48
Package dimensions	640 x 520 x 900H mm
Pallet dimensions	1300 x 1000 x 2150H mm

Size 4A2 - Size 4 - Size 4A5

	ARTICLE	SIZE 4A2	SIZE 4	SIZE 4A5	GR.	PACKAGING		UNIT PRICE €
						Qty. per pack.	Qty. per pallet	
A	CD C4A2 0099	■			360	1		
	CD C004 0099		■		500	1		
	CD C4A5 0099			■	540	1		
B	CD C004 7107		■		236	10		
	CD C4A5 7107			■	390	10		
C	CD C004 0199		■		368	1		
D	CW C004 6896		■		66	10		
	CW C4A5 6896			■	92	10		
E	LH C000 0099		■	■	100	1		
F	LB 7731 1801	■				1		
	LB 7742 1201		■	■		1		

DATASHEET

A

Galvanised longit. divider size 4A2	457 x 120Hmm
Galvanised longit. divider size 4	426 x 160H mm
Galvanised longit. divider size 4A5	460 x 249Hmm
Pieces per pack	📦 1

B

Plastic longit. divider size 4	460 x 160H mm
Plastic longit. divider size 4A5	460 x 250Hmm
Pieces per pack	📦 10

C

Galvanised transverse divider size 4	
Pieces per pack	📦 1

D

Dust cover size 4	
Dust cover size 4A5	
Pieces per pack	📦 10

E

Inclined galvanised tag holder for size 4 - 4A5	100 x 67 mm
Pieces per pack	1

F

Sheet 18 labels for size 4A2	77 x 31 mm
Sheet 12 labels for size 4 - 4A5	77 x 42 mm
Pieces per pack	📦 1



A



B



C









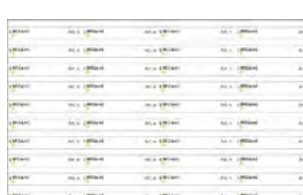



D



E





F

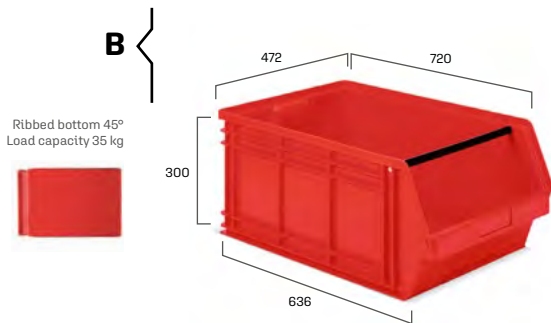
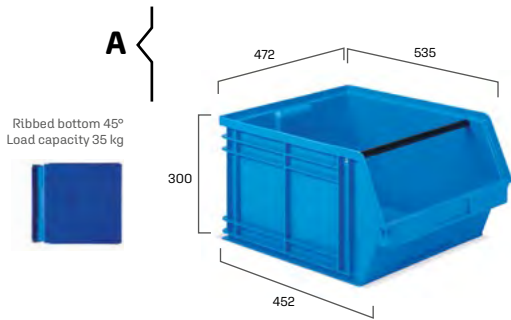

ARTICLE	RIBBED BOTTOM A 45°	SIZE 5P4	SIZE 5	GR.	PACKAGING		UNIT PRICE €
					Qty. per pack.	Qty. per pallet	
 CO Z5P4 5101	■	■		3370	18	42	
 CO Z5P4 5102	■	■		3370	18	42	
A  CO Z5P4 5103	■	■		3370	18	42	
 CO Z5P4 5104	■	■		3370	18	42	
 CO Z5P4 5105	■	■		3370	18	42	
 CO Z005 5101	■		■	4378	12	28	
 CO Z005 5102	■		■	4378	12	28	
B  CO Z005 5103	■		■	4378	12	28	
 CO Z005 5104	■		■	4378	12	28	
 CO Z005 5105	■		■	4378	12	28	



A

Volume	63 litres
Pieces per pack / pallet	 18  42
Package dimensions	1400 x 1100 x 1050H mm
Pallet dimensions	1400 x 1100 x 2100H mm

B

Volume	88 litres
Pieces per pack / pallet	 12  28
Package dimensions	1450 x 1000 x 1050H mm
Pallet dimensions	1450 x 1000 x 2100H mm

Size 5P4 - Size 5

	ARTICLE	SIZE 5P4	SIZE 5	GR.	PACKAGING		UNIT PRICE €
					Qty. per pack.	Qty. per pallet	
A	CS Z5P4 0199	■		1420	1		
	CS Z005 0199		■	1750	1		
B	CD Z5P4 0099	■		680	1		
	CD Z005 0099		■	1000	1		
C	LH Z000 0099	■	■	150	1		
D	LB 12739 1001	■	■		1		
E	LB 18985 0301	■	■		1		
F	ZE Z002 5101	■	■	264	54	1080	
	ZE Z002 5102	■	■	264	54	1080	
	ZE Z002 5103	■	■	264	54	1080	
	ZE Z002 5104	■	■	264	54	1080	
	ZE Z002 5105	■	■	264	54	1080	



A



B



C



D



E



F



DATASHEET

A	
Galvanised longit. divider size 5P4 with pair of galvanised transverse supports	473 x 215H mm
Galvanised longit. divider size 5 with pair of galvanised transverse supports	654 x 214H mm
Pieces per pack	📦 1 set
B	
Galvanised longit. divider size 5P4	473 x 215H mm
Galvanised longit. divider size 5	654 x 214H mm
Pieces per pack	📦 1
C	
Inclined galvanised tag holder for size 5P4 - 5	128 x 90 mm
Pieces per pack	📦 1
D	
Sheet 10 upper labels for size 5P4- 5	127 x 39 mm
Pieces per pack	📦 1
E	
Sheet 3 lower labels for size 5P4- 5	189 x 85 mm
Pieces per pack	📦 1
F	
Box for division into 6 compartments size 5P4 and into 8 compartments size 5	200 x 140 x 130H mm
Volume	88 litres
Pieces per pack / pallet	📦 54 📦 1080
Package dimensions	640 x 460 x 500H mm
Pallet dimensions	1400 x 1100 x 1660H mm

iMilani srl reserves the right to alter the characteristics of products without notice. The values shown are nominal, with a +/- 1% tolerance for size, depending on the material, and a +/- 3% for weight.

iMiCUBE
160



PRACTIBOX

The Practibox series of drawer units consists of grey ABS structures and high mechanical strength drawers in transparent polystyrene.

Available in models of different depth and height, they share a standard 600 mm width that allows stacking in a wide range of combinations.

DRAWERS



The drawers, made in high mechanical strength transparent polystyrene, are housed in the ABS container, designed to be positioned on Practibox shelves and in trolleys or fixed to the wall with anchor bolts.

iMiCUBE

161

STACKING



Practibox drawer units are available in different depths and heights but have a standard width of 600 mm. This features means that modules of the same depth or lesser depth can be stacked, allowing a wide range of combinations.

TILTED OPENING



Equipped with a handy tilting door opening, Practibox drawer units offer excellent access to the product.

ORDER



Equipped with a practical handle, Practibox drawer units meet the most varied needs.

Module width 600 mm



ARTICLE	WIDTH	DEPTH	HEIGHT	NUMBER OF TILTING DRAWERS	PACKAGING		UNIT PRICE €
					Qty. per pack	Qty. per pallet	
A PR 9077 0001	600	69	77	9	2	468	
	LB 03510 0901				10		
B PR 6112 0001	600	98	112	6	2	216	
	LB 05315 0601				10		
C PR 5164 0001	600	141	164	5	1	120	
	LB 08022 0501				10		
D PR 4206 0001	600	174	206	4	1	80	
	LB 08028 0401				10		
E PR 3240 0001	600	209	240	3	1	56	
	LB 12134 0301				10		
F PR 2353 0001	600	311	353	2	1	30	
	LB 12150 0201				10		

A

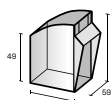

B

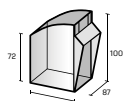

C

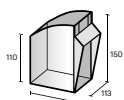

D

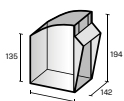

E

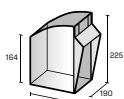

F

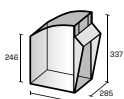

A - 9 drawers

Pieces per pack / pallet	2	468
Package dimensions	610 x 155 x 95H mm	
Pallet dimensions	1300 x 1000 x 1600H mm	
LB035100901	Sheet of 9 labels not included	

B - 6 drawers

Pieces per pack / pallet	2	216
Package dimensions	610 x 210 x 125H mm	
Pallet dimensions	1300 x 1000 x 1600H mm	
LB053150601	Sheet of 6 labels not included	

C - 5 drawers

Pieces per pack / pallet	1	120
Package dimensions	610 x 155 x 175H mm	
Pallet dimensions	1300 x 1000 x 2000H mm	
LB080220501	Sheet of 5 labels not included	

D - 4 drawers

Pieces per pack / pallet	1	80
Package dimensions	610 x 155 x 175H mm	
Pallet dimensions	1300 x 1000 x 2000H mm	
LB080280401	Sheet of 4 labels not included	

E - 3 drawers

Pieces per pack / pallet	1	56
Package dimensions	610 x 225 x 255H mm	
Pallet dimensions	1300 x 1000 x 2000H mm	
LB121340301	Sheet of 3 labels not included	

F - 2 drawers

Pieces per pack / pallet	1	30
Package dimensions	610 x 325 x 365H mm	
Pallet dimensions	1300 x 1000 x 2000H mm	
LB121500201	Sheet of 2 labels not included	

DATASHEET

Module width 610 mm

	ARTICLE	WIDTH	DEPTH	HEIGHT	NUMBER OF TILTING DRAWERS	PACKAGING		UNIT PRICE €
						Qty. per pack	Qty. per pallet	
A	PR D050 015 0301	610	174	500	15	1	-	
B	PR D050 0001	610	150	500	-	1	-	
C	PRT BOX 5104	350	200	465	18	1	-	
	PR ST90 0099	600				1	-	
	PR ST61 0099	600				1	-	
D	PR ST51 0099	600				1	-	
	PR ST42 0099	600				1	-	
	PR ST32 0099	600				1	-	
	PR ST23 0099	600				1	-	

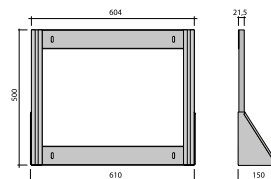

DATASHEET

A

Bench frame with drawers	1 x PR D050 0001
Drawers set	1 x PR 6112 0001
	1 x PR 5164 0001
	1 x PR 4206 0001

B

Bench frame without drawers	1 x PR D050 0001
-----------------------------	------------------

C

Top Box case	18 drawers type PR 6112 0001
--------------	------------------------------

D

Galvanised stop for PR 9077...	1 x PR ST90 0099
Galvanised stop for PR 6112...	1 x PR ST61 0099
Galvanised stop for PR 5164...	1 x PR ST51 0099
Galvanised stop for PR 4206...	1 x PR ST42 0099
Galvanised stop for PR 3240...	1 x PR ST32 0099
Galvanised stop for PR 2353...	1 x PR ST23 0099

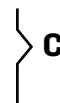
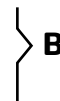
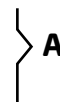

Release system



Galvanised stops

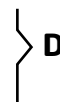

iMilani srl reserves the right to alter the characteristics of products without notice. The values shown are nominal, with a +/- 1% tolerance for size, depending on the material, and a +/- 3% for weight.

Module width 600 mm

ARTICLE	WIDTH	DEPTH	HEIGHT	NUMBER OF TILTING DRAWERS	PACKAGING		UNIT PRICE €
					Qty. per pack.	Qty. per pallet	
A PR F030 0001	600	28	300	-	1	-	
B PR F030 036 0101	600	78	308	36	1	-	
C PR F030 021 0201	600	107	300	21	1	-	
D PR F030 010 0101	600	150	10	1	-		



B



A

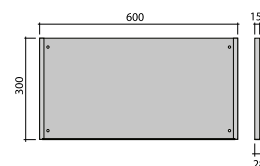

C



D



A	
Rear panel	1 x PR F030 0001
B	
Rear panel	1 x PR F030 0001
Drawers set	4 x PR 9077 0001
C	
Rear panel	1 x PR F030 0001
Drawers set	1 x PR 9077 0001
	2 x PR 6112 0001
D	
Rear panel	1 x PR F030 0001
Drawers set	2 x PR 5164 0001

DATASHEET

Module width 600 mm

	ARTICLE	WIDTH	DEPTH	HEIGHT	NUMBER OF TILTING DRAWERS	PACKAGING		UNIT PRICE €
						Qty. per pack.	Qty. per pallet	
A	PR F050 0001	600	28	500	-	1	-	
B	PR F050 054 0101	600	78	500	54	1	-	
C	PR F050 036 0201	600	107	500	36	1	-	
D	PR F050 015 0301	600	183	500	15	-		

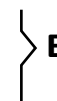
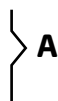
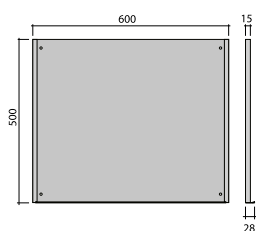

DATASHEET

A

Rear panel	1 x PR F050 0001
------------	------------------

B

Rear panel	1 x PR F050 0001
Drawers set	6 x PR 9077 0001

C

Rear panel	1 x PR F050 0001
Drawers set	2 x PR 9077 0001
	3 x PR 6112 0001

D

Rear panel	1 x PR F050 0001
Drawers set	1 x PR 6112 0001
	1 x PR 5164 0001
	1 x PR 4206 0001
	1 x PR 4206 0001

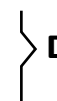
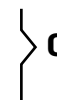

iMilani srl reserves the right to alter the characteristics of products without notice. The values shown are nominal, with a +/- 1% tolerance for size, depending on the material, and a +/- 3% for weight.

ARTICLE	WIDTH	DEPTH	HEIGHT	NUMBER OF TILTING DRAWERS	PACKAGING		UNIT PRICE €
					Qty. per pack	Qty. per pallet	
A PR F065 0001	600	28	650	-	1	-	
B PR F065 072 0101	600	78	650	72	1	-	
C PR F065 039 0201	600	107	650	39	1	-	
D PR F065 028 0201	600	150	664	28	1	-	



B



A

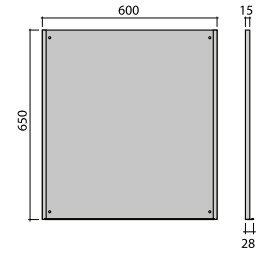

C



D



A

Rear panel	1 x PR F065 0001
------------	------------------

B

Rear panel	1 x PR F065 0001
Drawers set	8 x PR 9077 0001

C

Rear panel	1 x PR F065 0001
Drawers set	1 x PR 9077 0001
	5 x PR 6112 0001

C

Rear panel	1 x PR F065 0001
Drawers set	3 x PR 6112 0001
	2 x PR 5164 0001

Module width 600 mm

ARTICLE	WIDTH	DEPTH	HEIGHT	NUMBER OF TILTING DRAWERS	PACKAGING		UNIT PRICE €
					Qty. per pack	Qty. per pallet	
A PR F100 0001	600	41	1000	-	1	-	
B PR F100 084 0201	600	113	1022	84	1	-	
C PR F100 054 0101	600	113	1008	54	1	-	
D PR F100 029 0401	600	224	29	1	-		
E PR DBAS 0001	600	300	100		1		

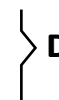
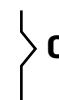
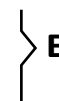
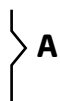
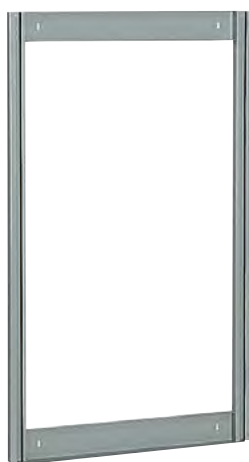
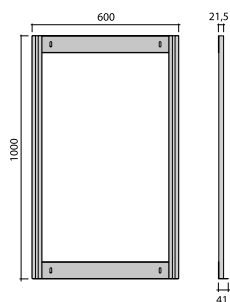

DATASHEET

A

Rear panel	1 x PR F100 0001
------------	------------------

B

Rear panel	1 x PR F100 0001
Drawers set	6 x PR 9077 0001
	5 x PR 6112 0001

C

Rear panel	1 x PR F100 0001
Drawers set	9 x PR 6112 0001

D

Rear panel	1 x PR F100 0001
Drawers set	2 x PR 6112 0001
	2 x PR 5164 0001
	1 x PR 4206 0001
	1 x PR 3240 0001

E

Optional base for shelf	1 x PR DBAS 0001
-------------------------	------------------

iMilani srl reserves the right to alter the characteristics of products without notice. The values shown are nominal, with a +/- 1% tolerance for size, depending on the material, and a +/- 3% for weight.

Module width 600 mm

ARTICLE	WIDTH	DEPTH	HEIGHT	NUMBER OF TILTING DRAWERS	PACKAGING		UNIT PRICE €
					Qty. per pack.	Qty. per pallet	
A PR F150 0001	600	41	1500	-	1	-	
B PR F150 123 0201	600	113	1500	123	1	-	
C PR F150 084 0101	600	113	1568	84	1	-	
D PR F150 064 0501	600	224	1540	64	1	-	
E PR DBAS 0001	600	300	100	-	1	-	



B



A

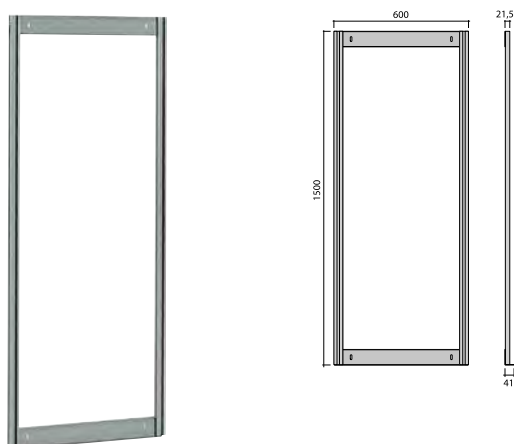

C



D



E



A	
Rear panel	1 x PR F150 0001
B	
Rear panel	1 x PR F150 0001
Drawers set	9 x PR 9077 0001
	7 x PR 6112 0001
C	
Rear panel	1 x PR F150 0001
Drawers set	14 x PR 6112 0001
D	
Rear panel	1 x PR F150 0001
Drawers set	2 x PR 9077 0001
	4 x PR 6112 0001
	3 x PR 5164 0001
	1 x PR 4206 0001
	1 x PR 3240 0001
E	
Optional base for shelf	1 x PR DBAS 0001

Module width 600 mm

	ARTICLE	WIDTH	DEPTH	HEIGHT	NUMBER OF TILTING DRAWERS	PACKAGING		UNIT PRICE €
						Qty. per pack.	Qty. per pallet	
A	PR F175 0001	600	41	1750	-	1	-	
B	PR F175 132 0201	600	113	1750	132	1	-	
C	PR F175 099 0201	600	113	1750	99	1	-	
D	PR F175 066 0501	600	224	66	1	-		
E	PR DBAS 0001	600	300	100		1		

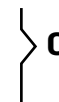
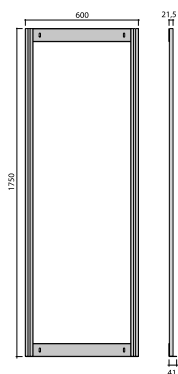

DATASHEET

A

Rear panel	1 x PR F175 0001
------------	------------------

B

Rear panel	1 x PR F175 0001
Drawers set	8 x PR 9077 0001
	10 x PR 6112 0001

C

Rear panel	1 x PR F175 0001
Drawers set	1 x PR 9077 0001
	15 x PR 6112 0001

D

Rear panel	1 x PR F175 0001
Drawers set	1 x PR 9077 0001
	6 x PR 6112 0001
	2 x PR 5164 0001
	2 x PR 4206 0001
	1 x PR 3240 0001

E

Optional base for shelf	1 x PR DBAS 0001
-------------------------	------------------

iMilani srl reserves the right to alter the characteristics of products without notice. The values shown are nominal, with a +/- 1% tolerance for size, depending on the material, and a +/- 3% for weight.

Module width 600 mm

ARTICLE	WIDTH	DEPTH	HEIGHT	NUMBER OF TILTING DRAWERS	PACKAGING		UNIT PRICE €
					Qty. per pack.	Qty. per pallet	
A PR F195 0001	600	41	1950	-	1	-	
B PR F195 144 0201	600	113	1960	144	1	-	
C PR F195 100 0301	600	156	1950	100	1	-	
D PR F195 043 0401	600	326	1989	43	1	-	
E PR DBAS 0001	600	300	100	-	1	-	



B



C



D



E



A

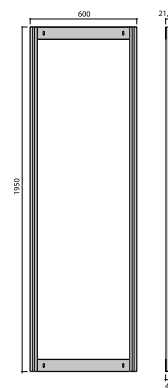

A	
Rear panel	1 x PR F195 0001
B	
Rear panel	1 x PR F195 0001
Drawers set	8 x PR 9077 0001
	12 x PR 6112 0001
C	
Rear panel	1 x PR F195 0001
Drawers set	3 x PR 9077 0001
	8 x PR 6112 0001
	5 x PR 5164 0001
D	
Rear panel	1 x PR F195 0001
Drawers set	6 x PR 5164 0001
	2 x PR 4206 0001
	1 x PR 3240 0001
	1 x PR 2353 0001
E	
Optional base for shelf	1 x PR DBAS 0001

Module width 600 mm - Module depth 325 mm

ARTICLE	WIDTH	DEPTH	HEIGHT	NUMBER OF TILTING DRAWERS	PACKAGING		UNIT PRICE €
					Qty. per pack.	Qty. per pallet	
A PR D150 0001	600	325	1500	-	1	-	
B PR D150 114 0201	600	325	1500	114	1	-	
C PR D150 078 0101	600	325	1556	78	1	-	
D PR D150 058 0501	600	325	1528	58	1	-	

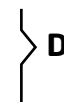
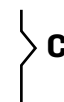
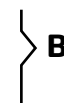
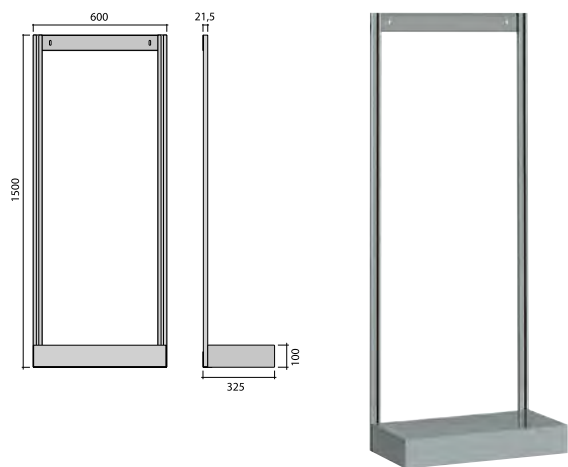

DATASHEET

A

Rear panel with base	1 x PR D150 0001
----------------------	------------------

B

Rear panel with base	1 x PR D150 0001
Drawers set	8 x PR 9077 0001
	7 x PR 6112 0001

C

Rear panel with base	1 x PR D150 0001
Drawers set	13 x PR 6112 0001

D

Rear panel with base	1 x PR D150 0001
Drawers set	2 x PR 9077 0001
	3 x PR 6112 0001
	3 x PR 5164 0001
	1 x PR 4206 0001
	1 x PR 3240 0001

iMilani srl reserves the right to alter the characteristics of products without notice. The values shown are nominal, with a +/- 1% tolerance for size, depending on the material, and a +/- 3% for weight.

Module width 600 mm - Module depth 325 mm

ARTICLE	WIDTH	DEPTH	HEIGHT	NUMBER OF TILTING DRAWERS	PACKAGING		UNIT PRICE €
					Qty. per pack	Qty. per pallet	
A PR D175 0001	600	325	1750	-	1	-	
B PR D175 112 0301	600	325	1786	112	1	-	
C PR D175 062 0501	600	325	1750	62	1	-	
D PR D175 057 0301	600	325	1770	57	1	-	



B



A

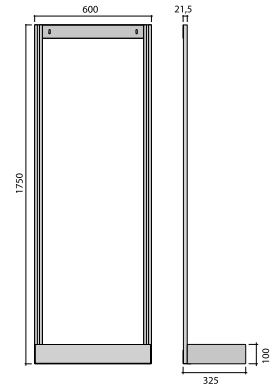
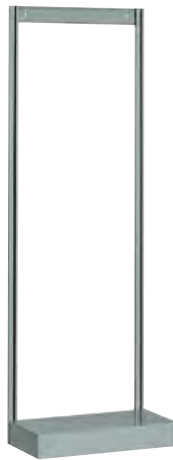

C



D



A	
Rear panel with base	1 x PR F175 0001
B	
Rear panel with base	1 x PR D175 0001
Drawers set	6 x PR 9077 0001
	8 x PR 6112 0001
	2 x PR 5164 0001
C	
Rear panel with base	1 x PR D175 0001
Drawers set	2 x PR 9077 0001
	3 x PR 6112 0001
	3 x PR 5164 0001
	2 x PR 4206 0001
	1 x PR 3240 0001
D	
Rear panel with base	1 x PR D175 0001
Drawers set	5 x PR 6112 0001
	3 x PR 5164 0001
	3 x PR 4206 0001

DATASHEET

Module width 600 mm - Module depth 325 mm

ARTICLE	WIDTH	DEPTH	HEIGHT	NUMBER OF TILTING DRAWERS	PACKAGING		UNIT PRICE €
					Qty. per pack.	Qty. per pallet	
A PR D195 0001	600	325	1950	-	1	-	
B PR D195 117 0401	600	325	1950	117	1	-	
C PR D195 066 0501	600	325	1950	66	1	-	
D PR D195 061 0301	600	325	1976	61	1	-	

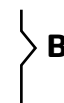
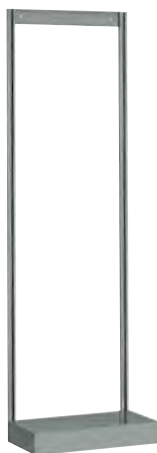
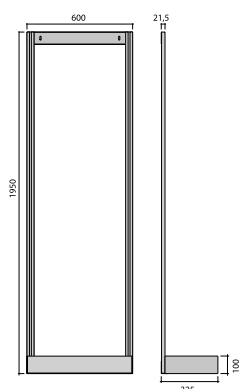

DATASHEET

A

Rear panel with base	1 x PR D195 0001
----------------------	------------------

B

Rear panel with base	1 x PR D195 0001
Drawers set	6 x PR 9077 0001
	9 x PR 6112 0001
	1 x PR 5164 0001
	1 x PR 4206 0001

C

Rear panel with base	1 x PR D195 0001
Drawers set	2 x PR 9077 0001
	3 x PR 6112 0001
	3 x PR 5164 0001
	3 x PR 4206 0001
	1 x PR 3240 0001

D

Rear panel with base	1 x PR D195 0001
Drawers set	5 x PR 6112 0001
	3 x PR 5164 0001
	4 x PR 4206 0001

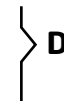
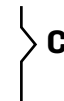

iMilani srl reserves the right to alter the characteristics of products without notice. The values shown are nominal, with a +/- 1% tolerance for size, depending on the material, and a +/- 3% for weight.



ARTICLE	WIDTH	DEPTH	HEIGHT	NUMBER OF TILTING DRAWERS	PACKAGING		UNIT PRICE €
					Qty. per pack.	Qty. per pallet	
A PR R186 260 0401	900	900	1865	260	1	-	
B PR R161 0001	900	900	1615	-	1	-	
C PR R186 0001	900	900	1865	-	1	-	
D PR R206 0001	900	900	2065	-	1	-	

A

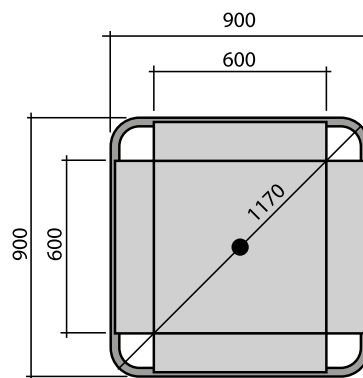

B
C
D

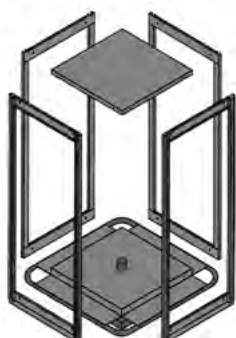

The Practibox swivel shelf consists of a 360° swivel base that houses 4 Practibox drawer unit holder frames, available in 3 different heights. Capacious, robust, practical – characteristics that make it usable in both large and small spaces.

The swivel base must be fixed to the floor

iMilani srl reserves the right to alter the characteristics of products without notice. The values shown are nominal, with a +/- 1% tolerance for size, depending on the material, and a +/- 3% for weight.

A

Swivel structure with 4 frames	1 x PR R186 0001
Drawers set	2 x PR 9077 0001
	18 x PR 6112 0001
	22 x PR 5164 0001
	6 x PR 4206 0001

B

Swivel structure with 4 frames	1 x PR R161 0001
--------------------------------	------------------

C

Swivel structure with 4 frames	1 x PR R186 0001
--------------------------------	------------------

D

Swivel structure with 4 frames	1 x PR R206 0001
--------------------------------	------------------





Cabinets with removable frames - Extractable frame holder 400 kg

	ARTICLE	WIDTH	DEPTH	HEIGHT	USABLE FRAME HEIGHT	PACKAGING		UNIT PRICE €
						Qty. per pack	Qty. per pallet	
A	PR COOL 5001	1073	705	2000	-	1	-	
B	PR COOL 7001	1481	705	2000	-	1	-	
C	PR C000 0401	-	705	1900	1765	1	-	
D	PR FIX 0099	-	-	-	-	2	-	

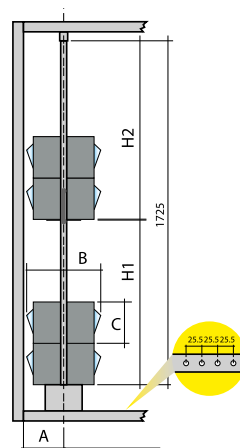
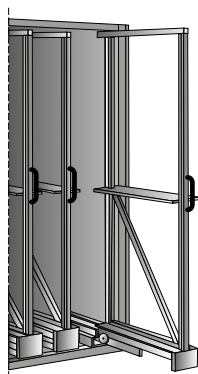

A
B

DATASHEET

A						
Cabinet for extractable frames with lock		PR COOL 5001				
Usable cabinet widthH mm		967				
B						
Cabinet for extractable frames with lock		PR COOL 7001				
Usable cabinet widthH mm		1375				
C						
Removable frame capacity 400 kg		PR C000 0401				
D						
Pair of anchor bolts for fixing a side unit				PR FIX 0099		
Drawer unit	A	B*	C	Q.ty H1	Q.ty H2	
PR 2353 ...	330.5	650	352	2	2	
PR 3240 ...	228.5	445	241	3	3	
PR 4206 ...	203.5	380	207	4	4	
PR 5164 ...	177.5	315	164	5	5	
PR 6112 ...	126.5	225	112	7	8	
PR 9077 ...	101.5	170	77	10	11	

B* - see usable width of cabinets without removable frames

* see useful width of cabinets without drawers



C



D

The cabinet must be fixed to the floor

iMilani srl reserves the right to alter the characteristics of products without notice. The values shown are nominal, with a +/- 1% tolerance for size, depending on the material, and a +/- 3% for weight.

Compositions with and without drawers – Extractable frame 400 kg

ARTICLE	WIDTH	DEPTH	HEIGHT	NUMBER OF TILTING DRAWERS	PACKAGING		UNIT PRICE €
					Qty. per pack	Qty. per pallet	
A PR C41L 5401	1073	705	2000	-	1	-	
B PR C41L 720 5401	1073	705	2000	720	1	-	
C PR C32L 5401	1073	705	2000	-	1	-	
D PR C32L 380 5401	1073	705	2000	380	1	-	
E PR C33L 5401	1073	705	2000	-	1	-	
F PR C33L 344 5401	1073	705	2000	344	1	-	



A
B

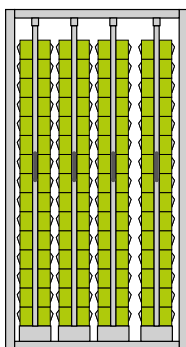

C
D

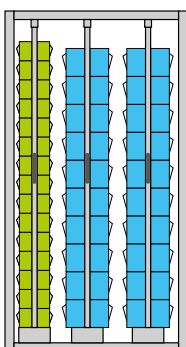

E
F

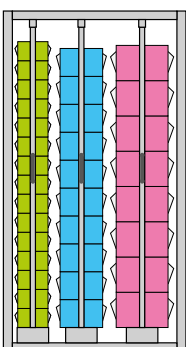



⚠ The cabinet must be fixed to the floor

iMilani srl reserves the right to alter the characteristics of products without notice. The values shown are nominal, with a +/- 1% tolerance for size, depending on the material, and a +/- 3% for weight.

A	
Cabinet with 4 extractable frames with lock	1 x PR C41L 5401
B	
Cabinet with 4 extractable frames with lock	1 x PR C41L 5401
Drawers set	120 x PR 6112 001
C	
Cabinet with 3 extractable frames with lock	1 x PR C32L 5401
D	
Cabinet with 3 extractable frames with lock	1 x PR C32L 5401
Drawers set	30 x PR 6112 001
	40 x PR 5164 001
E	
Cabinet with 3 extractable frames with lock	1 x PR C33L 5401
F	
Cabinet with 3 extractable frames with lock	1 x PR C33L 5401
Drawers set	30 x PR 6112 001
	20 x PR 5164 001
	16 x PR 4206 001

Compositions with and without drawers – Extractable frame 400 kg

ARTICLE	WIDTH	DEPTH	HEIGHT	NUMBER OF TILTING DRAWERS	PACKAGING		UNIT PRICE €
					Qty. per pack.	Qty. per pallet	
A PR C51L 7401	1481	705	2000	-	1	-	
B PR C51L 900 7401	1481	705	2000	900	1	-	
C PR C42L 7401	1481	705	2000	-	1	-	
D PR C42L 480 7401	1481	705	2000	480	1	-	
E PR C31L 7401	1481	705	2000	-	1	-	
F PR C31L 192 7401	1481	705	2000	192	1	-	

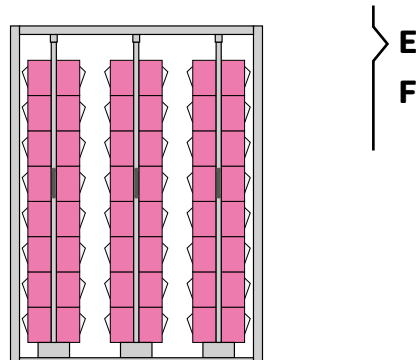
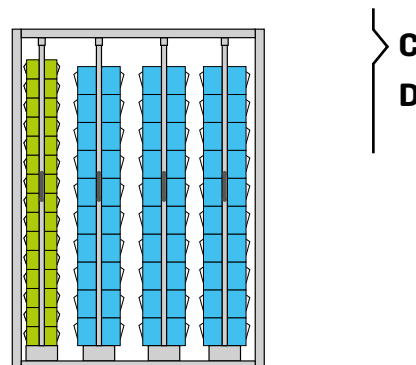
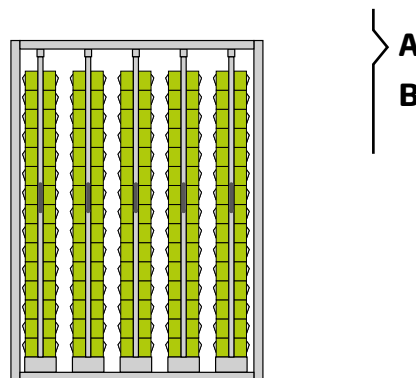

DATASHEET

A	
Cabinet with 5 extractable frames with lock	1 x PR C51L 7401
B	
Cabinet with 5 extractable frames with lock	1 x PR C51L 7401
Drawers set	150 x PR 6112 001
C	
Cabinet with 4 extractable frames with lock	1 x PR C42L 7401
D	
Cabinet with 4 extractable frames with lock	1 x PR C42L 7401
Drawers set	30 x PR 6112 001
	60 x PR 5164 001
E	
Cabinet with 3 extractable frames with lock	1 x PR C31L 7401
F	
Cabinet with 3 extractable frames with lock	1 x PR C31L 7401
Drawers set	48 x PR 4206 001

 The cabinet must be fixed to the floor

iMilani srl reserves the right to alter the characteristics of products without notice. The values shown are nominal, with a +/- 1% tolerance for size, depending on the material, and a +/- 3% for weight.

iMiCUBE
180



RK

Everything in order and clearly visible for flexible and functional storage: this is the result of the design and construction of the RK series of polypropylene boxes and their dedicated shelving system.

need, the drawers are ideal for spare parts dealers on account of their resistance to oils and their internal divisibility.

Available in eleven different sizes to meet every

WALLS



Made of top quality polypropylene, the RK boxes have walls strengthened with special ribbing to protect against shocks.

LABELS



Fitted with label holders available in various sizes proportionate to the size of the boxes to which they are applied.

HANDLES



A special handle can be supplied on request for easy lifting and transportation of the RK boxes.

BOTTOMS







smooth bottom



DIVIDERS



Made of transparent polystyrene, the dividers allow the inside of the boxes to be partitioned into several compartments.

	ARTICLE	BOTTOM WALLS HANDLES	TRANSVERSE DIVIDERS APPLICABLE	LONGITUDINAL DIVIDERS APPLICABLE	GR.	PACKAGING		UNIT PRICE €
						Qty. per pack.	Qty. per pallet	
		Closed						
	RK 3012 5104	■	4	1	340	32	512	
	RK 3012 5207	■	4	1	380	32	512	
	RK 3012 5401	■	4	1	374	32	512	
	RK 3016 5104	■	4	1	370	24	384	
	RK 3016 5207	■	4	1	414	24	384	
	RK 3016 5401	■	4	1	387	24	384	



A





B



A

Usable internal dimensions	257 x 95 x 97H mm
Pieces per pack / pallet	 32  512
Package dimensions	970 x 310 x 385H mm
Pallet dimensions	1300 x 1000 x 1700H m

B

Usable internal dimensions	257 x 136 x 97H mm
Pieces per pack / pallet	 24  384
Package dimensions	970 x 310 x 390H mm
Pallet dimensions	1300 x 1000 x 1700H m

Depth 300 mm - Width 120 - 160 mm

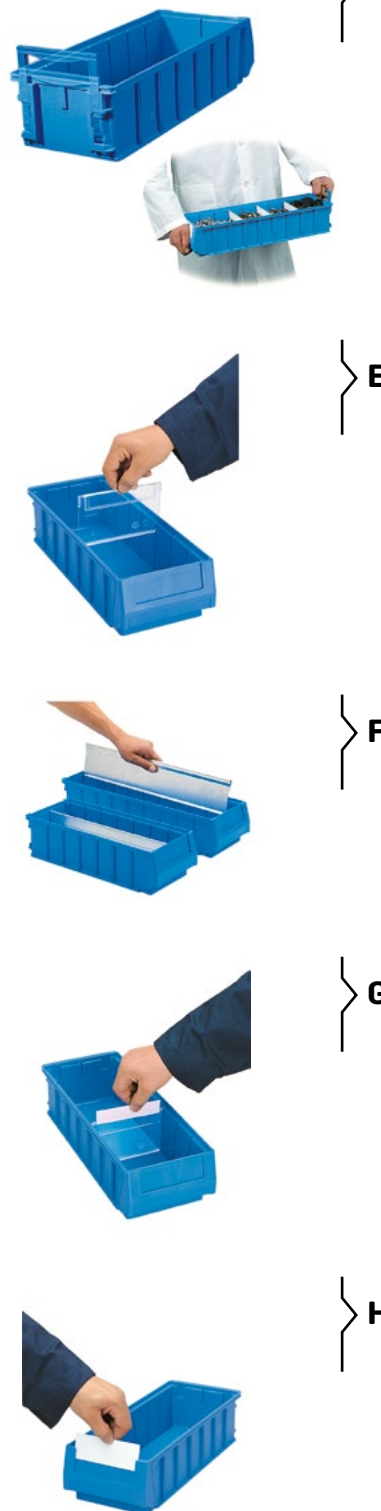

ARTICLE	DESCRIPTION	GR.	PACKAGING		UNIT PRICE €
			Qty. per pack.	Qty. per pallet	
D RK H120 5104	Handle facilitated grip for width 120 mm	16	1		 ECOGREEN
RK H120 5401		18	1		
RK H120 5207		19	1		
RK H160 5104	Handle facilitated grip for width 160 mm	18	1		 ECOGREEN
RK H160 5207		20	1		
RK H160 5401		19	1		
E RK D120 5207	Divider for width 120 mm	25	1		
RK D120 6896		22	1		
RK D160 5207	Divider for width 160 mm	32	1		
RK D160 6896		28	1		
F RK D300 0099	Galvanised longitudinal divider	200	1		
G LB 08024 2401	Divider label 120 mm		1		
LB 12124 1601	Divider label 160 mm		1		
H LB 08142 1201	Front Label for L = 120 mm		1		
LB 12144 0801	Front Label for L = 160 mm		1		



DATASHEET

D	
Handle for RK 3012	70 x 90H mm
Handle for RK 3016	110 x 90H mm
E	
Galvanised transverse divider size 3012	100 x 90H mm
Galvanised transverse divider size 3016	145 x 90H mm
F	
Galvanised longitudinal divider	268 x 88H mm
G	
Sheet of 24 labels for RK D120	80 x 24 mm
Sheet of 16 labels for RK D160	121 x 24 mm
H	
Sheet of 12 labels for RK 3012	81 x 42 mm
Sheet of 8 labels for RK 3016	121 x 44 mm

iMilani srl reserves the right to alter the characteristics of products without notice. The values shown are nominal, with a +/- 1% tolerance for size, depending on the material, and a +/- 3% for weight.

	ARTICLE	BOTTOM WALLS HANDLES	TRANSVERSE DIVIDERS APPLICABLE	LONGITUDINAL DIVIDERS APPLICABLE	GR.	PACKAGING		UNIT PRICE €
						Qty. per pack.	Qty. per pallet	
		Closed						
	RK 4012 5104	■	6	1	438	32	384	
	RK 4012 5207	■	6	1	491	32	384	
	RK 4012 5401	■	6	1	458	32	384	
	RK 4016 5104	■	6	1	448	24	288	
	RK 4016 5207	■	6	1	502	24	288	
	RK 4016 5401	■	6	1	468	24	288	
	RK 4024 5104	■	6	3	644	16	192	
	RK 4024 5207	■	6	3	721	16	192	
	RK 4024 5401	■	6	3	673	16	192	

A







B





C



A	
Usable internal dimensions	357 x 95 x 97H mm
Pieces per pack / pallet	 32  384
Package dimensions	970 x 415 x 400H mm
Pallet dimensions	1300 x 1000 x 1700H m

B	
Usable internal dimensions	357 x 136 x 97H mm
Pieces per pack / pallet	 24  288
Package dimensions	970 x 415 x 400H mm
Pallet dimensions	1300 x 1000 x 1700H m

C	
Usable internal dimensions	357 x 215 x 97H mm
Pieces per pack / pallet	 16  192
Package dimensions	970 x 415 x 400H mm
Pallet dimensions	1300 x 1000 x 1700H m

DATASHEET

Depth 400 mm - Width 120- 160 - 240 mm

ARTICLE	DESCRIPTION	GR.	PACKAGING		UNIT PRICE €
			Qty. per pack.	Qty. per pallet	
RK H120 5104	Handle facilitated grip for width 120 mm	16	1		
RK H120 5207		19	1		
RK H120 5401		18	1		
RK H160 5104	Handle facilitated grip for width 160 mm	18	1		
RK H160 5207		20	1		
RK H160 5401		19	1		
RK H240 5104	Handle facilitated grip for width 240 mm	20	1		
RK H240 5207		23	1		
RK H240 5401		22	1		
RK D120 5207	Divider for width 120 mm	25	1		
RK D120 6896		22	1		
RK D160 5207	Divider for width 160 mm	32	1		
RK D160 6896		28	1		
RK D240 5207	Divider for width 240 mm	56	1		
RK D240 6896		50	1		
RK D400 0099	Galvanised longitudinal divider	280	1		
LB 08024 2401	Divider label 120 mm		1		
LB 12124 1601	Divider label 160- 240 mm		1		
LB 08142 1201	Front Label for L = 120 mm		1		
LB 12144 0801	Front Label for L = 160 mm		1		
LB 20043 0601	Front Label for L = 240 mm		1		

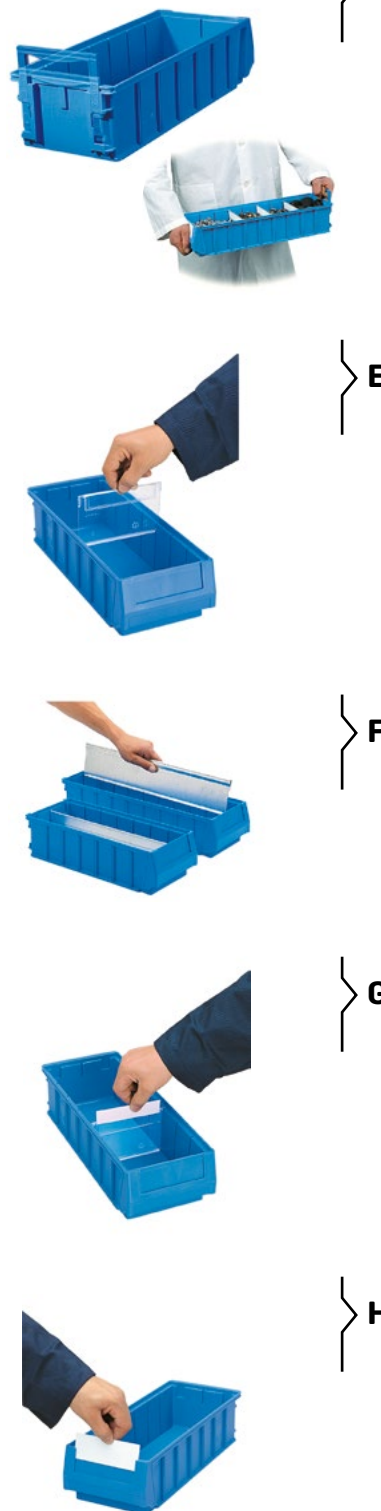

DATASHEET



D	
Handle for RK 4012	70 x 90H mm
Handle for RK 4016	110 x 90H mm
Handle for RK 4024	120 x 80H mm
E	
Galvanised transverse divider size 4012	100 x 90H mm
Galvanised transverse divider size 4016	145 x 90H mm
Galvanised transverse divider size 4024	125 x 90H mm
F	
Galvanised longitudinal divider	368 x 88H mm
G	
Sheet of 24 labels for RK D120	80 x 24 mm
Sheet of 16 labels for RK D160/RK D240	121 x 24 mm
H	
Sheet of 12 labels for RK 4012	81 x 42 mm
Sheet of 8 labels for RK 4016	121 x 44 mm
Sheet of 6 labels for RK 4024	200 x 43 mm

iMilani srl reserves the right to alter the characteristics of products without notice. The values shown are nominal, with a +/- 1% tolerance for size, depending on the material, and a +/- 3% for weight.



	ARTICLE	BOTTOM WALLS HANDLES	TRANSVERSE DIVIDERS APPLICABLE	LONGITUDINAL DIVIDERS APPLICABLE	GR.	PACKAGING		UNIT PRICE €
						Qty. per pack.	Qty. per pallet	
		Closed						
	RK 5012 5104	■	8	1	528	32	256	
A	RK 5012 5207	■	8	1	591	32	256	
	RK 5012 5401	■	8	1	552	32	256	
	RK 5016 5104	■	8	1	540	24	192	
B	RK 5016 5207	■	8	1	605	24	192	
	RK 5016 5401	■	8	1	564	24	192	
	RK 5024 5104	■	8	3	766	16	128	
C	RK 5024 5207	■	8	3	858	16	128	
	RK 5024 5401	■	8	3	800	16	128	





A

Usable internal dimensions	457 x 95 x 97H mm
Pieces per pack / pallet	 32  256
Package dimensions	970 x 515 x 390H mm
Pallet dimensions	1050 x 1000 x 1700H m

B

Usable internal dimensions	457 x 136 x 97H mm
Pieces per pack / pallet	 24  192
Package dimensions	970 x 515 x 390H mm
Pallet dimensions	1050 x 1000 x 1700H m

C

Usable internal dimensions	457 x 215 x 97H mm
Pieces per pack / pallet	 16  128
Package dimensions	970 x 515 x 390H mm
Pallet dimensions	1050 x 1000 x 1700H m

Depth 500 mm - Width 120- 160 - 240 mm

ARTICLE	DESCRIPTION	GR.	PACKAGING		UNIT PRICE €
			Qty. per pack.	Qty. per pallet	
RK H120 5104	Handle facilitated grip for width 120 mm	16	1		PP ECOGREEN
RK H120 5207		18	1		
RK H120 5401		19	1		
RK H160 5104	Handle facilitated grip for width 160 mm	16	1		PP ECOGREEN
RK H160 5207		18	1		
RK H160 5401		19	1		
RK H240 5104	Handle facilitated grip for width 240 mm	20	1		PP ECOGREEN
RK H240 5207		22	1		
RK H240 5401		23	1		
RK D120 5207	Divider for width 120 mm	25	1		
RK D120 6896		22	1		
RK D160 5207	Divider for width 160 mm	32	1		
RK D160 6896		28	1		
RK D240 5207	Divider for width 240 mm	56	1		
RK D240 6896		50	1		
F RK D500 0099	Galvanised longitudinal divider	360	1		
G LB 08024 2401	Divider label 120 mm		1		
LB 12124 1601	Divider label 160- 240 mm		1		
LB 08142 1201	Front Label for L = 120 mm		1		
H LB 12144 0801	Front Label for L = 160 mm		1		
LB 20043 0601	Front Label for L = 240 mm		1		



ECOGREEN



ECOGREEN



ECOGREEN



D

E

F

G

H

DATASHEET

D

Handle for RK 5012	70 x 90H mm
Handle for RK 5016	110 x 90H mm
Handle for RK 5024	120 x 80H mm

E

Galvanised transverse divider size 5012	100 x 90H mm
Galvanised transverse divider size 5016	145 x 90H mm
Galvanised transverse divider size 5024	125 x 90H mm

F

Galvanised longitudinal divider	468 x 88H mm
---------------------------------	--------------

G



Sheet of 24 labels for RK D120	80 x 24 mm
Sheet of 16 labels for RK D160/RK D240	121 x 24 mm

H

Sheet of 12 labels for RK 5012	81 x 42 mm
Sheet of 8 labels for RK 5016	121 x 44 mm
Sheet of 6 labels for RK 5024	200 x 43 mm

iMilani srl reserves the right to alter the characteristics of products without notice. The values shown are nominal, with a +/- 1% tolerance for size, depending on the material, and a +/- 3% for weight.

Depth 600 mm - Width 160 mm H 100

ARTICLE	BOTTOM WALLS HANDLES	TRANSVERSE DIVIDERS APPLICABLE	LONGITUDINAL DIVIDERS APPLICABLE	GR.	PACKAGING		UNIT PRICE €
	Closed				Qty. per pack.	Qty. per pallet	
 RK 6016 5104	■	10	1	662	24	192	
 RK 6016 5207	■	10	1	741	24	192	
 RK 6016 5401	■	10	1	692	24	192	

Depth 655 mm - Width 160 mm H 100

ARTICLE	BOTTOM WALLS HANDLES	TRANSVERSE DIVIDERS APPLICABLE	LONGITUDINAL DIVIDERS APPLICABLE	GR.	PACKAGING		UNIT PRICE €
	Closed				Qty. per pack.	Qty. per pallet	
 B RK 6516 5207	■	11	1	816	24	192	

Depth 434 mm - Width 140 mm H 80

ARTICLE	BOTTOM WALLS HANDLES	TRANSVERSE DIVIDERS APPLICABLE	LONGITUDINAL DIVIDERS APPLICABLE	GR.	PACKAGING		UNIT PRICE €
	Closed				Qty. per pack.	Qty. per pallet	
 C RK 4314 5104	■	7	-	324	30	540	

A





B





C





A

Usable internal dimensions	560 x 136 x 97H mm
Pieces per pack / pallet	 24  192
Package dimensions	970 x 620 x 390H mm
Pallet dimensions	1300 x 1000 x 1700H m

B

Usable internal dimensions	613 x 136 x 97H mm
Pieces per pack / pallet	 24  192
Package dimensions	980 x 670 x 390H mm
Pallet dimensions	1300 x 1000 x 1700H m

C

Usable internal dimensions	403 x 121 x 76H mm
Pieces per pack / pallet	 30  540
Package dimensions	450 x 410 x 460H mm
Pallet dimensions	1300 x 1000 x 1530H m

DATASHEET

Depth 600 mm - Width 160 mm

ARTICLE	DESCRIPTION	GR.	PACKAGING		UNIT PRICE €
			Qty. per pack.	Qty. per pallet	
D RK H160 5104	Handle facilitated grip for width 160 mm	16	1		
RK H160 5207		18	1		
RK H160 5401		19	1		
RK D140 6896	Divider for width 140 mm	22	1		
E RK D160 5207	Divider for width 160 mm	32	1		
RK D160 6896		28	1		
F RK D600 0099	Galvanised longitudinal divider	420	1		
G LB 8024 2401	Divider label 140 mm		1		
LB 12124 1601	Divider label 160 mm		1		
H LB 12144 0801	Front label for L=140/160 mm		1		



ECOGREEN



D



E



F



G



H

DATASHEET

D

Handle for RK 6016	120 x 90H mm
--------------------	--------------

E

Galvanised transverse divider size 4314	137 x 75H mm
Galvanised transverse divider size 6016	145 x 90H mm

F

Galvanised longitudinal divider for RK6016	568 x 88H mm
--	--------------

G

Sheet of 24 labels for RK D140	80 x 24 mm
Sheet of 16 labels for RK D160	121 x 24 mm

H

Sheet of 8 labels for RK 4314-6016-6516	121 x 44 mm
---	-------------

A



B



C



D



ARTICLE	RK 3012	RK 3016	GR.	PACKAGING		UNIT PRICE €
				Qty. per pack.	Qty. per pallet	
A RK BX30 0001				1		
B RK BX31 5104	16			1		
C RK BX32 5104		12		1		
D RK BX33 5104	8	6		1		



Compositions complete with guides and rear stops

A

Box	1 x RK BX30 0001
-----	------------------

B

Box	1 x RK BX30 0001
Drawers set	16 x RK 3012 5104

C

Box	1 x RK BX30 0001
Drawers set	12 x RK 3016 5104

D

Box	1 x RK BX30 0001
Drawers set	8 x RK 3012 5104
	6 x RK 3016 5104

Depth 300 mm

ARTICLE	DESCRIPTION	GR.	PACKAGING		UNIT PRICE €
			Qty. per pack.	Qty. per pallet	
I RK F300 0001	Plinth for RK-BOX depth 300		1		
L RK RL30 0099	Guide for RK-BOX depth 300		1		
M RK S500 0099	Galvanised front stop		1		
N	RK S120 1099	Galvanised rear front 120 mm	1		
	RK S160 2099	Galvanised rear front 160 mm	1		

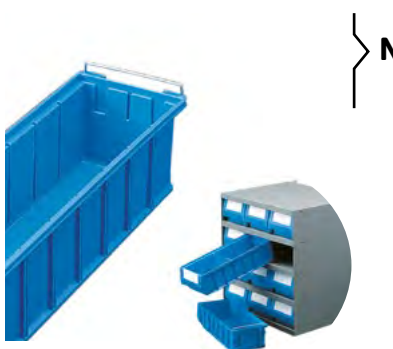
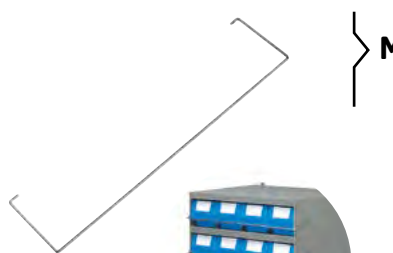

DATASHEET

I	
Plinth for BX40	485 x 275 x 90H mm
L	
Galvanised guides for BX40	400 mm
M	
Galvanised stop for RK-BOX	485 mm
N	
Galvanised rear stop	120 - 160 mm

iMilani srl reserves the right to alter the characteristics of products without notice. The values shown are nominal, with a +/- 1% tolerance for size, depending on the material, and a +/- 3% for weight.



500 x 545 H - Depth 400 mm

ARTICLE	RK 4012	RK 4016	RK 4024	GR.	PACKAGING		UNIT PRICE €
					Qty. per pack.	Qty. per pallet	
A RK BX40 0001					1		
B RK BX41 5104	16				1		
C RK BX42 5104		12			1		
D RK BX43 5104	8	6			1		



Compositions complete with guides and rear stops



A



B



C



D

iMilani
193

DATASHEET

A	
Box	1 x RK BX40 0001
B	
Box	1 x RK BX40 0001
Drawers set	16 x RK 4012 5104
C	
Box	1 x RK BX40 0001
Drawers set	12 x RK 4016 5104
D	
Box	1 x RK BX40 0001
Drawers set	8 x RK 4012 5104
	6 x RK 4016 5104

iMilani srl reserves the right to alter the characteristics of products without notice. The values shown are nominal, with a +/- 1% tolerance for size, depending on the material, and a +/- 3% for weight.

E



F



G



H



ARTICLE	RK 4012	RK4016	RK 4024	GR.	PACKAGING		UNIT PRICE €
					Qty. per pack.	Qty. per pallet	
E RK BX44 5104			8		1		
F RK BX45 5104	8		4		1		
G RK BX46 5104		6	4		1		
H RK BX47 5104	4	6	2		1		

Compositions complete with guides and rear stops

E	
Box	1 x RK BX40 0001
Drawers set	8 x RK 4024 5104
F	
Box	1 x RK BX40 0001
Drawers set	8 x RK 4012 5104
	4 x RK 4024 5104
G	
Box	1 x RK BX40 0001
Drawers set	6 x RK 4016 5104
	4 x RK 4024 5104
H	
Box	1 x RK BX40 0001
Drawers set	4 x RK 4012 5104
	6 x RK 4016 5104
	2 x RK 4024 5104

Depth 400 mm

ARTICLE	DESCRIPTION	GR.	PACKAGING		UNIT PRICE €
			Qty. per pack.	Qty. per pallet	
I RK F400 0001	Plinth for RK-BOX depth 400		1		
L RK RL40 0099	Guide for RK-BOX depth 400		1		
M RK S500 0099	Galvanised stop for RK-BOX		1		
N	RK S120 0099	Galvanised rear front 120 mm	1		
	RK S160 0099	Galvanised rear front 160 mm	1		

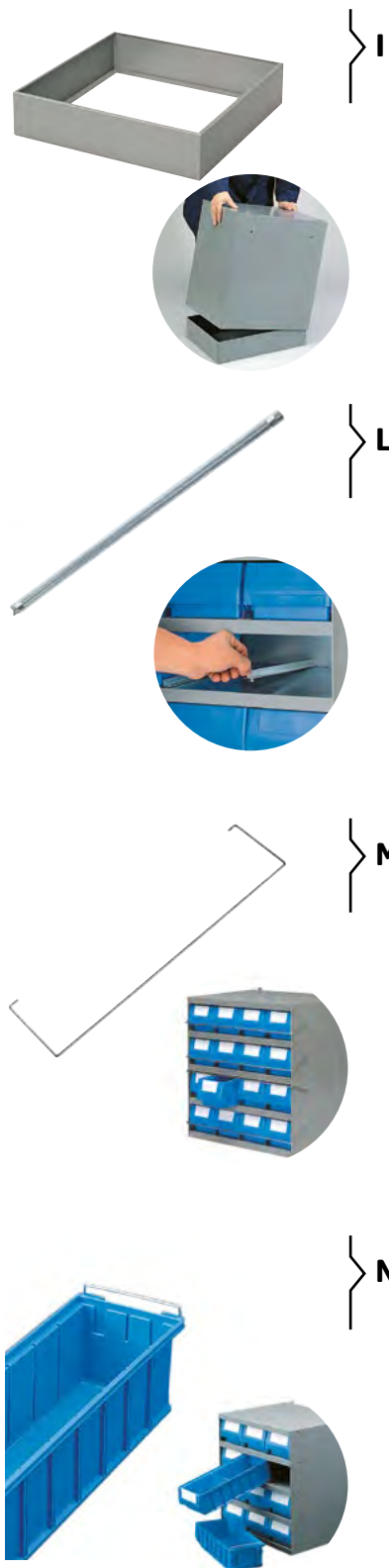

DATASHEET

I	
Plinth for BX40	485 x 375 x 90H mm
L	
Galvanised guides for BX40	400 mm
M	
Galvanised stop for RK-BOX	485 mm
N	
Galvanised rear stop	120 - 160 mm

iMilani srl reserves the right to alter the characteristics of products without notice. The values shown are nominal, with a +/- 1% tolerance for size, depending on the material, and a +/- 3% for weight.



500 x 545 H - Depth 500 mm

ARTICLE	RK 5012	RK 5016	RK 5024	GR.	PACKAGING		UNIT PRICE €
					Qty. per pack.	Qty. per pallet	
A RK BX50 0001					1		
B RK BX51 5104	16				1		
C RK BX52 5104		12			1		
D RK BX53 5104	8	6			1		



Compositions complete with guides and rear stops



A



B



C



D

iMilani
197

DATASHEET

A	
Box	1 x RK BX50 0001
B	
Box	1 x RK BX50 0001
Drawers set	16 x RK 5012 5104
C	
Box	1 x RK BX50 0001
Drawers set	12 x RK 5016 5104
D	
Box	1 x RK BX50 0001
Drawers set	8 x RK 5012 5104
	6 x RK 5016 5104

iMilani srl reserves the right to alter the characteristics of products without notice. The values shown are nominal, with a +/- 1% tolerance for size, depending on the material, and a +/- 3% for weight.

E



F







G



H



ARTICLE	RK 5012	RK 5016	RK 5024	GR.	PACKAGING		UNIT PRICE €
					Qty. per pack.	Qty. per pallet	
 E RK BX54 5104			8		1		162.37
 F RK BX55 5104	8		4		1		186.12
 G RK BX56 5104		6	4		1		172.22
 H RK BX57 5104	4	6	2		1		184.12

Compositions complete with guides and rear stops

E

Box	1 x RK BX50 0001
Drawers set	8 x RK 5024 5104

F

Box	1 x RK BX50 0001
Drawers set	8 x RK 5012 5104
	4 x RK 5024 5104

G

Box	1 x RK BX50 0001
Drawers set	6 x RK 5016 5104
	4 x RK 5024 5104

H

Box	1 x RK BX50 0001
Drawers set	4 x RK 5012 5104
	6 x RK 5016 5104
	2 x RK 5024 5104

Depth 500 mm

ARTICLE	DESCRIPTION	GR.	PACKAGING		UNIT PRICE €
			Qty. per pack.	Qty. per pallet	
I RK F500 0001	Plinth for RK-BOX depth 500		1		39.31
L RK RL50 0099	Guide for RK-BOX depth 500		1		2.82
M RK S500 0099	Galvanised stop for RK-BOX		1		1.27
N	RK S120 0099	Galvanised rear front 120 mm	1		0.50
	RK S160 0099	Galvanised rear front 160 mm	1		0.50



DATASHEET

I	
Plinth for BX40	485 x 375 x 90H mm
L	
Galvanised guides for BX40	400 mm
M	
Galvanised stop for RK-BOX	485 mm
N	
Galvanised rear stop	120 - 160 mm

iMilani srl reserves the right to alter the characteristics of products without notice. The values shown are nominal, with a +/- 1% tolerance for size, depending on the material, and a +/- 3% for weight.

ARTICLE	RK6016			GR.	PACKAGING		UNIT PRICE €
					Qty. per pack.	Qty. per pallet	
A RK BX60 0001					1		
B RK BX61 5104	12				1		



Composition complete with guides and rear stops

A



B



A

Box	1 x RK BX60 0001
-----	------------------

B

Box	1 x RK BX60 0001
Drawers set	12 x RK 6016 5104

Depth 600 mm

ARTICLE	DESCRIPTION	GR.	PACKAGING		UNIT PRICE €
			Qty. per pack.	Qty. per pallet	
I RK F600 0001	Plinth for RK-BOX depth 600		1		
L RK RL60 0099	Guide for RK-BOX depth 600		1		
M RK S500 0099	Galvanised stop for RK-BOX		1		
N	RK S120 0099	Galvanised rear front 120 mm	1		
	RK S160 0099	Galvanised rear front 160 mm	1		



iMilani
201

DATASHEET

I	
Plinth for BX60	485 x 575 x 90H mm
L	
Galvanised guides for BX60	600 mm
M	
Galvanised stop for RK-BOX	485 mm
N	
Galvanised rear stop	120 - 160 mm

iMilani srl reserves the right to alter the characteristics of products without notice. The values shown are nominal, with a +/- 1% tolerance for size, depending on the material, and a +/- 3% for weight.

innovative
italian
ideas

iMilani

ACCESSORIES

iMiCUBE
202



ZEUS

The Zeus box series meets the most exacting needs for goods containment, handling and storage. Manageable, lightweight and easy to clean thanks to a perfectly smooth interior, they have a sturdy edge

that allows stable and safe stacking. Stackability combined with high storage capacity results in ideal use of space.

BOTTOMS

smooth bottom



ribbed bottom



bottom ribbed at 45°
with crossbar

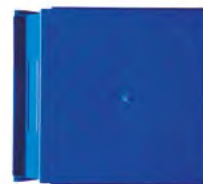

iMiCUBE

203

SIDE REINFORCEMENT



Lateral reinforcement on the bottom allows the boxes to be stacked safely even when fully loaded.





































HANDLES - WALLS

closed handle closed walls





Size 701 - Size 702 - Size 272-2

	ARTICLE	SMOOTH BOTTOM	SIZE 701	SIZE 702	SIZE 272-2	GR.	PACKAGING		UNIT PRICE €	
							Qty. per pack.	Qty. per pallet		
A	ZE Z701 5101	■	■				66	50 1600		                 
	ZE Z701 5102	■	■				66	50 1600		
	ZE Z701 5103	■	■				66	50 1600		
	ZE Z701 5104	■	■				66	50 1600		
	ZE Z701 5105	■	■				66	50 1600		
	ZE Z701 5207	■	■				74	50 1600		
B	ZE Z702 5101	■		■			106	30 960	           	
	ZE Z702 5102	■		■			106	30 960		
	ZE Z702 5103	■		■			106	30 960		
	ZE Z702 5104	■		■			106	30 960		
	ZE Z702 5105	■		■			106	30 960		
	ZE Z702 5207	■		■			119	30 960		
C	ZE Z002 5101	■			■		264	54 1080	      	
	ZE Z002 5102	■			■		264	54 1080		
	ZE Z002 5103	■			■		264	54 1080		
	ZE Z002 5104	■			■		264	54 1080		
	ZE Z002 5105	■			■		264	54 1080		
	ZE Z002 5207	■			■		296	54 1080		

Size 701
144 x 91 x 70H mm

A

iMiCUBE
205



Size 702
144 x 139 x 70H mm

B







Size 272-2
211 x 148 x 126H mm



C



DATASHEET

A	
Stacked edge height	65 mm
Usable stacked height / Volume	63 mm / 0.9 litres
Dimensions	144 x 91 x 70H mm
Usable internal dimensions	123 x 81 x 68H mm
Pieces per pack / pallet	 50  1600
Package dimensions	470 x 300 x 350H mm
Pallet dimensions	1200 x 1000 x 1550H mm

B	
Stacked edge height	65 mm
Usable stacked height / Volume	63 mm / 1.4 litres
Dimensions	144 x 139 x 70H mm
Usable internal dimensions	124 x 126 x 68H mm
Pieces per pack / pallet	 30  960
Package dimensions	470 x 300 x 350H mm
Pallet dimensions	1200 x 1000 x 1550H mm

C	
Stacked edge height	112 mm
Usable stacked height / Volume	110 mm / 3.6 litres
Dimensions	211 x 148 x 126H mm
Usable internal dimensions	187 x 125 x 124H mm
Pieces per pack / pallet	 54  1080
Package dimensions	720 x 460 x 500H mm
Pallet dimensions	1450 x 1200 x 2100H mm

iMilani srl reserves the right to alter the characteristics of products without notice. The values shown are nominal, with a +/- 1% tolerance for size, depending on the material, and a +/- 3% for weight.

iMiCUBE
206

Ribbed bottom
Load capacity 15 kg



A

Size 272-3A2
310 x 210 x 145H mm



Ribbed bottom
Load capacity 15 kg



B

Size 272-4A2
465 x 315 x 120H mm



Ribbed bottom
Load capacity 20 kg



C

Size 272-4
465 x 315 x 200H mm



D

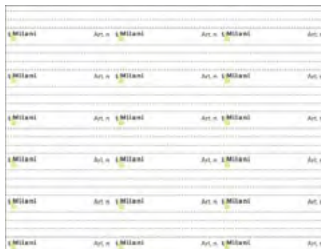

ARTICLE	RIBBED BOTTOM	SIZE 272-3A2	SIZE 272-4A2	SIZE 272-4	GR.	PACKAGING		UNIT PRICE €
						Qty. per pack.	Qty. per pallet	
ZE Z3A2 5101	■	■			522	21	252	
ZE Z3A2 5102	■	■			522	21	252	
ZE Z3A2 5103	■	■			522	21	252	
ZE Z3A2 5104	■	■			522	21	252	
ZE Z3A2 5105	■	■			522	21	252	
ZE Z3A2 5207	■	■			585	21	252	
ZE Z4A2 5101	■		■		972	16	128	
ZE Z4A2 5102	■		■		972	16	128	
ZE Z4A2 5103	■		■		972	16	128	
ZE Z4A2 5104	■		■		972	16	128	
ZE Z4A2 5105	■		■		972	16	128	
ZE Z4A2 5207	■		■		1089	16	128	
ZE Z004 5101	■			■	1270	10	80	
ZE Z004 5102	■			■	1270	10	80	
ZE Z004 5103	■			■	1270	10	80	
ZE Z004 5104	■			■	1270	10	80	
ZE Z004 5105	■			■	1270	10	80	
ZE Z004 5207	■			■	1422	10	80	
LB 18292 0301			■				1	
LB 18985 0301				■			1	

A

Stacked edge height	132 mm
Usable stacked height / Volume	130 mm / 8.7 litres
Dimensions	310 x 210 x 145H mm
Usable internal dimensions	284 x 184 x 142H mm
Pieces per pack / pallet	📦 21 🚚 252
Package dimensions	360 x 640 x 980H mm
Pallet dimensions	1350 x 1100 x 2110H mm

B

Stacked edge height	107 mm
Usable stacked height / Volume	105 mm / 16.2 litres
Dimensions	465 x 315 x 120H mm
Usable internal dimensions	423 x 275 x 118H mm
Pieces per pack / pallet	📦 16 🚚 128
Package dimensions	640 x 520 x 900H mm
Pallet dimensions	1300 x 1000 x 2150H mm

C

Stacked edge height	183 mm
Usable stacked height / Volume	181 mm / 27 litres
Dimensions	465 x 315 x 200H mm
Usable internal dimensions	464 x 277 x 195H mm
Pieces per pack / pallet	📦 10 🚚 80
Package dimensions	640 x 520 x 980H mm
Pallet dimensions	1300 x 1000 x 2150H mm

D

Sheet of 3 labels for size 272-4A2	182 x 92H mm
Sheet of 3 labels for size 272-4	189 x 85H mm

Size 272-4A5 - Size 272-5

	ARTICLE	RIBBED BOTTOM 45°	SIZE 272-4A5	SIZE 272-5	GR.	PACKAGING		UNIT PRICE €
						Qty. per pack.	Qty. per pallet	
A	ZE Z4A5 5101	■	■			1824	6 48	
	ZE Z4A5 5102	■	■			1824	6 48	
	ZE Z4A5 5103	■	■			1824	6 48	
	ZE Z4A5 5104	■	■			1824	6 48	
	ZE Z4A5 5105	■	■			1824	6 48	
B	ZE Z005 5101	■		■		4355	3 28	
	ZE Z005 5102	■		■		4355	3 28	
	ZE Z005 5103	■		■		4355	3 28	
	ZE Z005 5104	■		■		4355	3 28	
	ZE Z005 5105	■		■		4355	3 28	
C	LB 18985 0301		■	■		1		



A

Ribbed bottom 45°
Load capacity 35 kg



B

Ribbed bottom 45°
Load capacity 35 kg

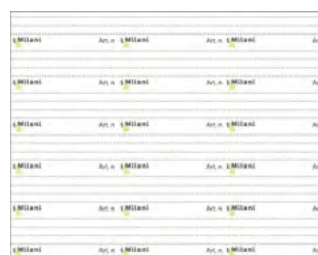

C

DATASHEET

A	
Stacked edge height	285 mm
Usable stacked height / Volume	283 mm / 40.5 litres
Dimensions	465 x 315 x 300H mm
Usable internal dimensions	426 x 276 x 297H mm
Pieces per pack / pallet	6 48
Package dimensions	640 x 520 x 900H mm
Pallet dimensions	1300 x 1000 x 2150H mm

B	
Stacked edge height	278 mm
Usable stacked height / Volume	276 mm / 85 litres
Dimensions	655 x 470 x 300H mm
Usable internal dimensions	604 x 429 x 297H mm
Pieces per pack / pallet	3 28
Package dimensions	675 x 490 x 900H mm
Pallet dimensions	1300 x 1000 x 2150H mm

C	
Sheet of 3 labels for size 272-4A5 and 272-5	189 x 85H mm

iMiCUBE
207



HOLDER

RS

rigid with support



ARTICLE	DIMENSIONS MM	FOR LABEL FORMAT	PRICE € PACK. 10 PZ.
LH A414 RS	215 x 80 x 17 H	1/4 DIN A4 - 210 x 75	
LH A500 RS	215 x 155 x 17 H	DIN A5 - 210 x 148	

RA

rigid with adhesive



ARTICLE	DIMENSIONS MM	FOR LABEL FORMAT	PRICE € PACK. 10 PZ.
LH A700 RA	110 x 83	DIN A5 - 105 x 74	
LH A414 RA	220 x 83	1/4 DIN A4 - 210 x 75	
LH A500 RA	220 x 160	DIN A5 - 210 x 148	

iMiCUBE

209

MI

soft insertion



ARTICLE	DIMENSIONS MM	FOR LABEL FORMAT MM	PRICE € PACK. 10 PZ.
LH A414 MI	210 x 80	1/4 DIN A4 - 210 x 75	
LH A413 MI	210 x 100	1/3 DIN A4 - 210 x 99	
LH A500 MI	210 x 147	DIN A5 - 210 x 148	

MF

soft with slot



ARTICLE	DIMENSIONS MM	FOR LABEL FORMAT	PRICE € PACK. 10 PZ.
LH A414 MF	210 x 80	1/4 DIN A4 - 210 x 75	

INSERTABLE LABEL FORMATS

DIN size in mm

DIN A7

110 x 83

1/4 DIN A4

210 x 75

1/3 DIN A4

210 x 99

DIN A5

210 x 160

ATHENA BOX SERIES



LABEL HOLDER WITH SUPPORT



iMiCUBE
210

ARTICLE
LH A414 RS

ARTICLE
LH A500 RS

PART CODE ATHENA	EDGE 1/4 A4		EDGE A5	
	SHORT SIDE	LONG SIDE	SHORT SIDE	LONG SIDE
	AT 3212 A	0	2	0
AT 3217 A	0	2	0	2
AT 4305 A	0	0	0	0
AT 4308 A	0	0	0	0
AT 4312 A	2	2	0	0
AT 4312 C	2	2	0	0
AT 4312 P	2	2	0	0
AT 4317 A	2	2	2	2
AT 4317 C	2	2	2	2
AT 4322 A	2	2	2	2
AT 4322 B	2	2	2	2
AT 4322 D	2	2	2	2
AT 4332 A	2	2	2	2
AT 4332 B	2	2	2	2
AT 6408 A	0	0	0	0
AT 6412 A	2	2	0	0
AT 6412 C	2	2	0	0
AT 6412 G	2	2	0	0
AT 6412 H	2	2	0	0
AT 6417 A	2	2	2	2
AT 6417 C	2	2	2	2
AT 6422 A	2	2	2	2
AT 6422 B	2	2	2	2
AT 6422 D	2	2	2	2
AT 6422 S	2	2	2	2
AT 6428 A	2	2	2	2
AT 6428 B	2	2	2	2
AT 6428 D	2	2	2	2
AT 6432 A	2	2	2	2
AT 6432 B	2	2	2	2
AT 6432 D	2	2	2	2
AT 6432 R	2	2	2	2
AT 6443 B	2	2	2	2
AT 6443 R	2	2	2	2
AT 6443 V	2	1	2	1
AT 6443 U	1	2	1	2
AT 8612 C	0	0	0	0
AT 8617 C	0	0	0	0
AT 8622 C	0	0	0	0
AT 8632 C	0	0	0	0
AT 8643 W	0	0	0	0

NOT APPLICABLE

NUMBER OF SIDES APPLICABLE
WITHOUT THE USE OF THE HANDLE

NUMBER OF SIDES APPLICABLE

ATHENA BOX SERIES



LABEL HOLDER WITH ADHESIVE



PART CODE ATHENA	ARTICLE LH A414 RA		ARTICLE LH A500 RA		ARTICLE LH A700 RA	
	ADHESIVE 1/4 A4		ADHESIVE A5		ADHESIVE A7	
	SHORT SIDE	LONG SIDE	SHORT SIDE	LONG SIDE	SHORT SIDE	LONG SIDE
AT 3212 A	0	0	0	0	0	0
AT 3217 A	0	0	0	0	2	2
AT 4305 A	0	0	0	0	0	0
AT 4308 A	0	0	0	0	0	0
AT 4312 A	0	0	0	0	0	0
AT 4312 C	0	0	0	0	0	0
AT 4312 P	0	0	0	0	0	0
AT 4317 A	0	2	0	0	2	2
AT 4317 C	0	2	0	0	2	2
AT 4322 A	0	2	0	1	2	2
AT 4322 B	0	2	0	1	2	2
AT 4322 D	0	2	0	1	2	2
AT 4332 A	0	2	0	2	2	2
AT 4332 B	0	2	0	2	2	2
AT 6408 A	0	0	0	0	0	0
AT 6412 A	0	0	0	0	0	0
AT 6412 C	0	0	0	0	0	0
AT 6412 G	0	0	0	0	0	0
AT 6412 H	0	0	0	0	0	0
AT 6417 A	1	2	0	0	2	2
AT 6417 C	1	2	0	0	2	2
AT 6422 A	2	2	0	2	2	2
AT 6422 B	2	2	0	2	2	2
AT 6422 D	2	2	0	2	2	2
AT 6422 S	0	0	0	0	0	0
AT 6428 A	2	2	2	2	2	2
AT 6428 B	2	2	2	2	2	2
AT 6428 D	2	2	2	2	2	2
AT 6432 A	2	2	2	2	2	2
AT 6432 B	2	2	2	2	2	2
AT 6432 D	2	2	2	2	2	2
AT 6432 R	0	0	0	0	0	0
AT 6443 B	2	1	2	0	2	2
AT 6443 R	0	0	0	0	0	0
AT 6443 V	2	1	2	0	2	2
AT 6443 U	2	1	1	0	2	2
AT 8612 C	0	0	0	0	0	0
AT 8617 C	2	2	0	0	2	2
AT 8622 C	2	2	0	0	2	2
AT 8632 C	2	2	2	2	2	2
AT 8643 W	2	2	2	2	2	2

ATHENA LIGHT BOX SERIES

iMiCUBE
212



LABEL HOLDER WITH SUPPORT



ARTICLE
LH A414 RS



ARTICLE
LH A500 RS

PART CODE ATHENA LIGHT	EDGE 1/4 A4		EDGE A5	
	SHORT SIDE	LONG SIDE	SHORT SIDE	LONG SIDE
	AL 6422 A	2	2	2
AL 6422 B	2	2	2	2
AL 6422 D	2	2	2	2

LABEL HOLDER WITH ADHESIVE



ARTICLE
LH A414 RA



ARTICLE
LH A500 RA



ARTICLE
LH A700 RA

PART CODE ATHENA LIGHT	ADHESIVE 1/4 A4		ADHESIVE A5		ADHESIVE A7	
	SHORT SIDE	LONG SIDE	SHORT SIDE	LONG SIDE	SHORT SIDE	LONG SIDE
	AL 6422 A	1	0	0	0	2
AL 6422 B	1	0	0	0	2	2
AL 6422 S	0	0	0	0	0	0

NOT APPLICABLE

NUMBER OF SIDES APPLICABLE
WITHOUT THE USE OF THE HANDLE

NUMBER OF SIDES APPLICABLE

ODETTE BOX SERIES

LABEL HOLDER WITH SUPPORT



PART CODE ODETTE	ARTICLE LH A414 RS		ARTICLE LH A500 RS	
	EDGE 1/4 A4		EDGE A5	
	SHORT SIDE	LONG SIDE	SHORT SIDE	LONG SIDE
0 D 4 9 5 0	0	2	0	0
0 D 4 9 3 0	2	2	2	2
0 D 4 9 1 0	2	2	2	2
0 D 4 9 0 0	2	2	2	2

iMiCUBE
213

LABEL HOLDER WITH ADHESIVE



PART CODE ODETTE	ARTICLE LH A414 RA		ARTICLE LH A500 RA		ARTICLE LH A700 RA	
	ADHESIVE 1/4 A4		ADHESIVE A5		ADHESIVE A7	
	SHORT SIDE	LONG SIDE	SHORT SIDE	LONG SIDE	SHORT SIDE	LONG SIDE
0 D 4 9 5 0	0	0	0	0	0	0
0 D 4 9 3 0	0	0	0	0	0	1
0 D 4 9 1 0	0	0	0	0	0	1
0 D 4 9 0 0	0	0	0	0	2	0

NOT APPLICABLE

NUMBER OF SIDES APPLICABLE
WITHOUT THE USE OF THE HANDLE

NUMBER OF SIDES APPLICABLE

RL-KLT BOX SERIES

iMiCUBE
214



LABEL HOLDER WITH SUPPORT



ARTICLE
LH A414 RS



ARTICLE
LH A500 RS

PART CODE RL-KLT	EDGE 1/4 A4		EDGE A5	
	SHORT SIDE	LONG SIDE	SHORT SIDE	LONG SIDE
	K L 3 1 4 7	0	2	0
K L 4 1 4 7	2	2	0	0
K L 4 2 8 0	2	2	2	2
K L 6 1 4 7	2	2	0	0
K L 6 2 8 0	2	2	2	2

LABEL HOLDER WITH ADHESIVE



ARTICLE
LH A414 RA



ARTICLE
LH A500 RA



ARTICLE
LH A700 RA

PART CODE RL-KLT	ADHESIVE 1/4 A4		ADHESIVE A5		ADHESIVE A7	
	SHORT SIDE	LONG SIDE	SHORT SIDE	LONG SIDE	SHORT SIDE	LONG SIDE
	K L 3 1 4 7	0	0	0	0	2
K L 4 1 4 7	0	0	0	0	2	1
K L 4 2 8 0	0	1	0	1	2	2
K L 6 1 4 7	0	0	0	0	0	2
K L 6 2 8 0	1	0	0	0	2	2

NOT APPLICABLE

NUMBER OF SIDES APPLICABLE
WITHOUT THE USE OF THE HANDLE

NUMBER OF SIDES APPLICABLE

R-KLT BOX SERIES

LABEL HOLDER WITH SUPPORT



iMiCUBE
215

PART CODE R-KLT	ARTICLE LH A414 RS		ARTICLE LH A500 RS	
	EDGE 1/4 A4		EDGE A5	
	SHORT SIDE	LONG SIDE	SHORT SIDE	LONG SIDE
K L 3 2 1 5	0	2	0	0
K L 4 3 1 5	2	2	0	0
K L 4 3 2 9	2	2	2	2
K L 6 4 1 5	2	2	0	0
K L 6 4 2 9	2	2	2	2

LABEL HOLDER WITH ADHESIVE



PART CODE R-KLT	ARTICLE LH A414 RA		ARTICLE LH A500 RA		ARTICLE LH A700 RA	
	ADHESIVE 1/4 A4		ADHESIVE A5		ADHESIVE A7	
	SHORT SIDE	LONG SIDE	SHORT SIDE	LONG SIDE	SHORT SIDE	LONG SIDE
K L 3 2 1 5	0	0	0	0	2	0
K L 4 3 1 5	0	0	0	0	2	0
K L 4 3 2 9	0	1	0	1	2	2
K L 6 4 1 5	0	0	0	0	0	0
K L 6 4 2 9	1	0	0	0	2	2

NOT APPLICABLE

NUMBER OF SIDES APPLICABLE
WITHOUT THE USE OF THE HANDLE

NUMBER OF SIDES APPLICABLE

MINERVA BOX SERIES

iMiCUBE
216



LABEL HOLDER WITH SUPPORT



ARTICLE
LH A414 RS



ARTICLE
LH A500 RS

PART CODE MINERVA	EDGE 1/4 A4		EDGE A5	
	SHORT SIDE	LONG SIDE	SHORT SIDE	LONG SIDE
	MI 6420 B	0	0	0
MI 6420 S	0	0	0	0
MI 6430 B	0	2	0	0
MI 6430 S	0	2	0	0
MI 6440 B	0	2	0	0
MI 6440 S	0	2	0	0

LABEL HOLDER WITH ADHESIVE



ARTICLE
LH A414 RA



ARTICLE
LH A500 RA



ARTICLE
LH A700 RA

PART CODE MINERVA	ADHESIVE 1/4 A4		ADHESIVE A5		ADHESIVE A7	
	SHORT SIDE	LONG SIDE	SHORT SIDE	LONG SIDE	SHORT SIDE	LONG SIDE
	MI 6420 B	0	2	0	0	2
MI 6420 S	0	0	0	0	0	0
MI 6430 B	0	2	0	2	2	2
MI 6430 S	0	0	0	0	0	0
MI 6440 B	0	2	0	2	2	2
MI 6440 S	0	0	0	0	0	0

NOT APPLICABLE

NUMBER OF SIDES APPLICABLE

DELTA BOX SERIES

LABEL HOLDER WITH SUPPORT



iMilani
217

PART CODE DELTA	ARTICLE LH A414 RS		ARTICLE LH A500 RS	
	EDGE 1/4 A4		EDGE A5	
	SHORT SIDE	LONG SIDE	SHORT SIDE	LONG SIDE
DE 6422 A	0	0	0	0
DE 6432 A	0	2	0	0
DE 6442 A	0	2	0	0
DE 6422 B	0	0	0	0
DE 6432 B	0	2	0	0
DE 6442 B	0	2	0	0
DE 6422 C	0	0	0	0
DE 6432 C	0	0	0	0
DE 6442 C	0	0	0	0

LABEL HOLDER WITH ADHESIVE



PART CODE DELTA	ARTICLE LH A700 RA		ARTICLE LH A500 RA		ARTICLE LH A414 RA	
	ADHESIVE A7		ADHESIVE A5		ADHESIVE 1/4 A4	
	SHORT SIDE	LONG SIDE	SHORT SIDE	LONG SIDE	SHORT SIDE	LONG SIDE
DE 6422 A	2	2	2	2	2	2
DE 6432 A	2	2	2	2	2	2
DE 6442 A	2	2	2	2	2	2
DE 6422 B	2	2	2	2	2	2
DE 6432 B	2	2	2	2	2	2
DE 6442 B	2	2	2	2	2	2
DE 6422 C	2	2	2	2	2	2
DE 6432 C	2	2	2	2	2	2
DE 6442 C	2	2	2	2	2	2

NOT APPLICABLE

NUMBER OF SIDES APPLICABLE

ZEUS BOX SERIES

LABEL HOLDER WITH ADHESIVE



iMiCUBE
218



ARTICLE
LH A414 RA



ARTICLE
LH A500 RA



ARTICLE
LH A700 RA

PART CODE ZEUS	ADHESIVE 1/4 A4		ADHESIVE A5		ADHESIVE A7	
	SHORT SIDE	LONG SIDE	SHORT SIDE	LONG SIDE	SHORT SIDE	LONG SIDE
	Z E Z 0 0 2	0	0	0	0	0
Z E Z 3 A 2	0	2	0	0	0	2
Z E Z 4 A 2	1	2	0	0	1	2
Z E Z 0 0 4	1	2	0	2	1	2
Z E Z 4 A 5	1	2	1	2	1	2
Z E Z 0 0 5	0	0	0	0	2	2

NOT APPLICABLE

NUMBER OF SIDES APPLICABLE

COMPAT BOX SERIES



LABEL HOLDER WITH ADHESIVE



ARTICLE
LH A414 RA

ARTICLE
LH A500 RA

ARTICLE
LH A700 RA

iMiCUBE
219

PART CODE ZEUS COMPAT	ADHESIVE 1/4 A4		ADHESIVE A5		ADHESIVE A7	
	SHORT SIDE	LONG SIDE	SHORT SIDE	LONG SIDE	SHORT SIDE	LONG SIDE
	C O C 0 0 1	0	0	0	0	0
C O C 0 0 2	0	0	0	0	0	2
C O C 3 A 2	0	2	0	0	0	2
C O C 0 0 3	0	2	0	2	0	2
C O Z 3 L 5	0	2	0	0	0	2
C O C 4 A 2	0	2	0	0	0	2
C O C 0 0 4	0	2	0	2	0	2
C O C A 4 5	0	2	0	2	1	2
C O Z 5 P 4	0	0	0	0	1	2
C O Z 0 0 5	0	0	0	0	1	2

NOT APPLICABLE

NUMBER OF SIDES APPLICABLE

STEEL



222

FOX



236

QUICK





FRAME

256



PICK

266



SQUARE

276



iMiCUBE
222

FOX trolleys are supplied complete with 2 shelves and Athena boxes or alternatively with 2 shelves and Compat containers.

Additional shelves complete with boxes and containers can be supplied separately.

Alternatively, FOX trolleys can also be ordered complete with 2 groups of Practibox tilting containers.

Again, the trolley can be supplemented by ordering additional shelves equipped as per the user's needs.

FOX

WIDTH

The FOX trolley series is available with a height of 1430 mm and 2 different widths:

- Free span shelves 657 mm for FOX 06 trolleys
- Free span shelves 955 mm for FOX 08 trolleys

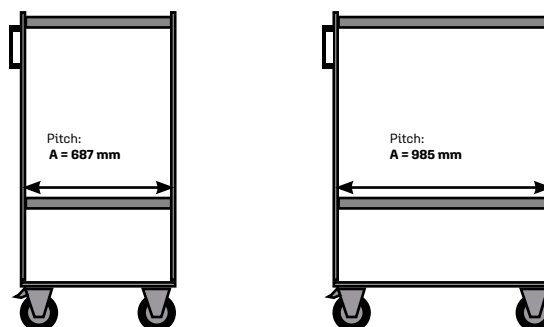

SHELVES AND WHEELS



The tiltable shelves for FOX trolleys of length 955 mm and pitch 985 mm can be in 4 depths: 220, 320, 420 and 600 mm.

The tiltable shelves for FOX trolleys of length 657 mm and pitch 687 mm can be in 2 depths: 220 and 420 mm.

In addition to tilted shelves, the trolley is also configurable for fixed shelves for containers, with different depths available in both cases.

The trolleys are supplied as standard with mounted wheels and disassembled frame.

125 mm diameter rubber wheels, 2 fixed and 2 swivel with brakes, are supplied as standard.

ACCESSORIES

To make the best use of the trolley spaces, optional accessories are available such as Practibox containers and reinforcing cross supports.



ADJUSTMENTS

The perforated crosspiece base allows for adjustment of the uprights and the insertion of different types of boxes, giving maximum flexibility for installation of the smallest to the largest boxes.

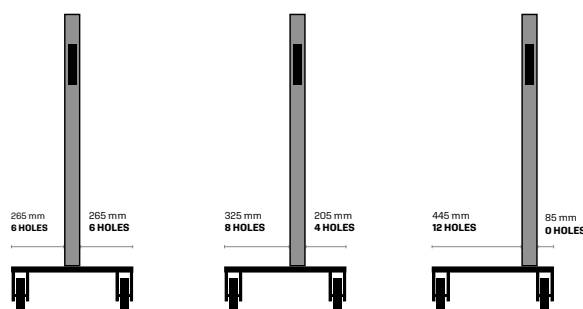

Trolley dimensions

1023 x 613 mm H 1430 mm

FOX

iMiCUBE

224

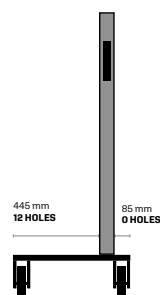
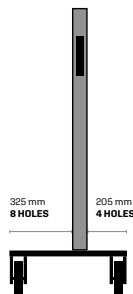
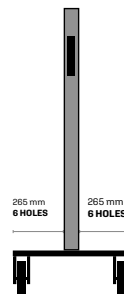

Trolley dimensions

725 x 613 mm H 1430 mm

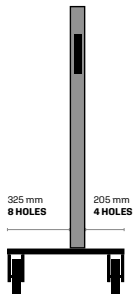
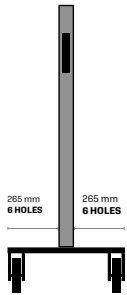

FOX

iMiCUBE
225

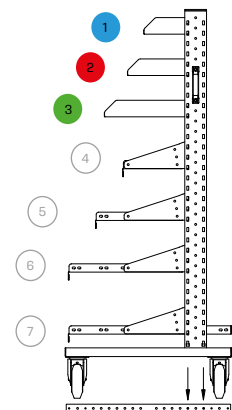
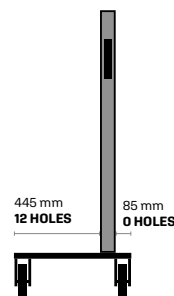
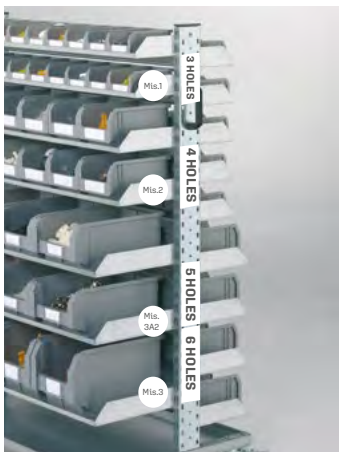
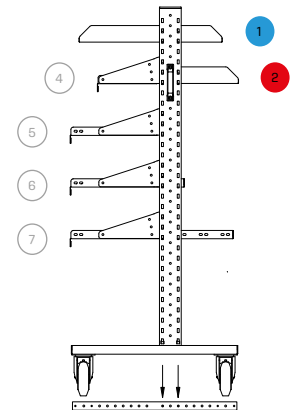
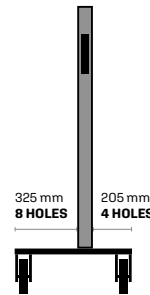
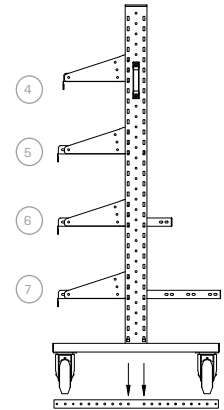
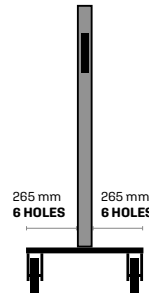

974 x 150 mm

974 x 205 mm

974 x 295 mm

Shelves COMPAT containers

Fixed shelf in galvanised steel - capacity 25 kg - L = 974 mm









KIT consisting of

- Trolley 1023 x 613 x 1430H mm

- 2 identical shelves complete with containers

iMiCUBE

227

SHELF DEPTH mm	NO. OF CONTAINERS	CONTAINER DIMENSIONS mm			MATERIAL	CODE	KIT PRICE €	CODE	PRICE OF ADDITIONAL SHELF WITH CONTAINERS €		
		L	P	H							
150	9	95	160/140	75	 PP	FXT 00199 5101		FX 00199 5101			
						FXT 00199 5102		FX 00199 5102			
		FXT 00199 5103		FX 00199 5103							
		FXT 00199 5104		FX 00199 5104							
		FXT 00199 5105		FX 00199 5105							
		ECOGREEN 	FXT 00199 5401		FX 00199 5401						
		205	6	140	230/200	130	 PP	FXT00269 5101		FX 00269 5101	
								FXT 00269 5102		FX 00269 5102	
				FXT 00269 5103		FX 00269 5103					
				FXT 00269 5104		FX 00269 5104					
FXT 00269 5105				FX 00269 5105							
ECOGREEN 	FXT 00269 5401				FX 00269 5401						
295	4			200	350/300	200	 PP	FXT 00349 5101		FX 00349 5101	
								FXT 00349 5102		FX 00349 5102	
				FXT 00349 5103		FX 00349 5103					
				FXT 00349 5104		FX 00349 5104					
		FXT 00349 5105		FX 00349 5105							
		ECOGREEN 	FXT 00349 5401		FX 00349 5401						
		295	4	200	350/300	145	 PP	FXT 3A249 5101		FX 3A249 5101	
								FXT 3A249 5102		FX3 A249 5102	
				FXT 3A249 5103		FX3 A249 5103					
				FXT 3A249 5104		FX 3A249 5104					
FXT 3A249 5105				FX 3A249 5105							
ECOGREEN 	FXT 3A249 5401				FX 3A249 5401						

Load capacities are net and refer to evenly distributed loads.

The accessories and the materials stored in the truck must not protrude from the base of the truck.

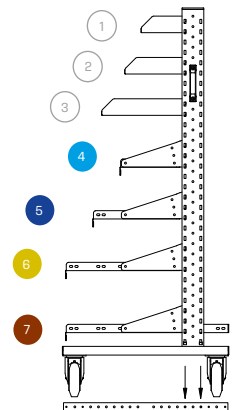
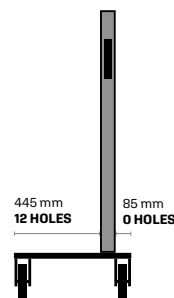
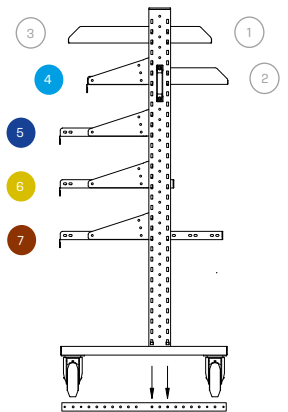
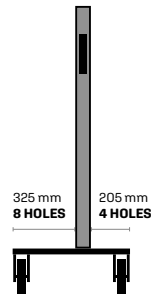
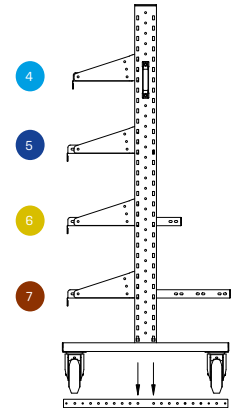
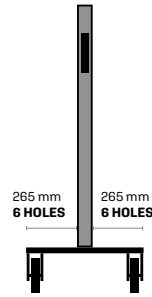

Shelves dimensions

955 x 220 mm - 955 x 320 mm
955 x 420 mm - 955 x 600 mm

ATHENA box shelves

Tiltable shelf in galvanised steel - load capacity 50 kg - L = 955 mm

KIT consisting of
 - Trolley 1023 x 613 x 1430H mm
 - 2 identical shelves complete with boxes

SHELF DEPTH mm	EXAMPLE	NO. OF BOXES	BOX DIMENSIONS mm			FRONT PICKING mm	MATERIAL	CODE	KIT PRICE €	CODE	PRICE OF ADDITIONAL SHELF WITH BOXES €
			L	P	H						
4 220		3	300	200	120	300		FXT3212A395101		FX3212A395101	
								FXT3212A3951XB		FX3212A3951XB	
		3	300	200	170	300		FXT3217A395101		FX3217A395101	
								FXT3217A3951XB		FX3217A3951XB	
		3	300	200	170	300		FXT3217A395101		FX3217A395101	
								FXT3217A3951XB		FX3217A3951XB	
5 320		4	300	200	120	200		FXT3212A495101		FX3212A495101	
								FXT3212A4951XB		FX3212A4951XB	
		4	300	200	170	200		FXT3217A495101		FX3217A495101	
								FXT3217A4951XB		FX3217A4951XB	
		4	300	200	170	200		FXT3217A495101		FX3217A495101	
								FXT3217A4951XB		FX3217A4951XB	
		2	400	300	120	400		FXT4312A295101		FX4312A295101	
								FXT4312A2951XB		FX4312A2951XB	
		2	400	300	170	400		FXT4317A295101		FX4317A295101	
								FXT4317A2951XB		FX4317A2951XB	
		2	400	300	220	400		FXT4322A295101		FX4322A295101	
								FXT4322A2951XB		FX4322A2951XB	
6 420		3	400	300	120	300		FXT4312A395101		FX4312A395101	
								FXT4312A3951XB		FX4312A3951XB	
		3	400	300	170	300		FXT4317A395101		FX4317A395101	
								FXT4317A3951XB		FX4317A3951XB	
		3	400	300	220	300		FXT4322A395101		FX4322A395101	
								FXT4322A3951XB		FX4322A3951XB	
7 600		2	600	400	120	400		FXT6412A295101		FX6412A295101	
								FXT6412A2951XB		FX6412A2951XB	
		2	600	400	170	400		FXT6417A295101		FX6417A295101	
								FXT6417A2951XB		FX6417A2951XB	
		2	600	400	220	400		FXT6422A295101		FX6422A295101	
								FXT6422A2951XB		FX6422A2951XB	
		1	800	600	120	800		FXT8612C195101		FX8612C195101	
								FXT8612C1951XB		FX8612C1951XB	
		1	800	600	170	800		FXT8617C195101		FX8617C195101	
								FXT8617C1951XB		FX8617C1951XB	
		1	800	600	220	800		FXT8622C195101		FX8622C195101	
								FXT8622C1951XB		FX8622C1951XB	

Load capacities are net and refer to evenly distributed loads.
 The accessories and the materials stored in the truck must not protrude from the base of the truck.

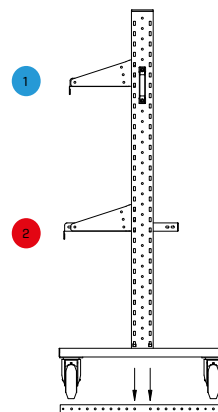
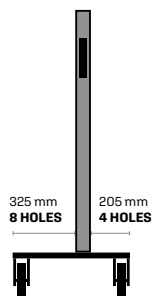
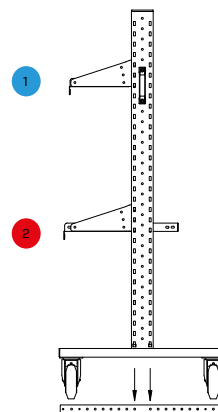
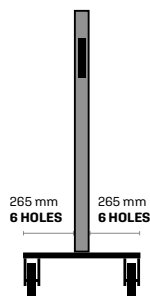

657 x 220 mm

657 x 420 mm

Shelves COMPAT containers

Tilttable shelf in galvanised steel - load capacity 50 kg - L = 657 mm













KIT consisting of

- Trolley 725 x 613 x 1430H mm

- 2 identical shelves complete with containers

iMiCUBE

231

SHELF DEPTH mm	NO. OF CONTAINERS	CONTAINER DIMENSIONS mm			MATERIAL	CODE	KIT PRICE €	CODE	PRICE OF ADDITIONAL SHELF WITH CONTAINERS €
		L	P	H					
220	6	95	160/140	75	 PP	FXT 00166 5101		FX 00166 5101	
						FXT 00166 5102		FX 00166 5102	
		FXT 00166 5103		FX 00166 5103					
		FXT 00166 5104		FX 00166 5104					
		FXT 00166 5105		FX 00166 5105					
		ECOGREEN 	FXT 00166 5401			FX 00166 5401			
		 SIZE 1							
220	4	140	230/200	130	 PP	FXT 00246 5101		FX 00246 5101	
						FXT 00246 5102		FX 00246 5102	
		FXT 00246 5103		FX 00246 5103					
		FXT 00246 5104		FX 00246 5104					
		FXT 00246 5105		FX 00246 5105					
		ECOGREEN 	FXT00246 5401			FX 00246 5401			
		 SIZE 2							
420	3	200	350/300	200	 PP	FXT 00336 5101		FX 00336 5101	
						FXT00336 5102		FX 00336 5102	
		FXT 00336 5103		FX 00336 5103					
		FXT 00336 5104		FX 00336 5104					
		FXT 00336 5105		FX 00336 5105					
		ECOGREEN 	FXT00336 5401			FX 00336 5401			
		 SIZE 3							
420	3	200	350/300	145	 PP	FXT 3A236 5101		FX 3A236 5101	
						FXT 3A236 5102		FX 3A236 5102	
		FXT 3A236 5103		FX 3A236 5103					
		FXT 3A236 5104		FX 3A236 5104					
		FXT 3A236 5105		FX 3A236 5105					
		ECOGREEN 	FXT 3A236 5401			FX 3A236 5401			
		 SIZE 3A2							

Load capacities are net and refer to evenly distributed loads.

The accessories and the materials stored in the truck must not protrude from the base of the truck.

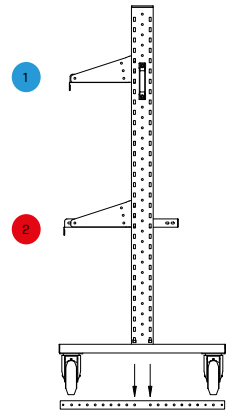
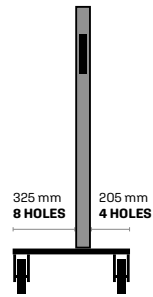
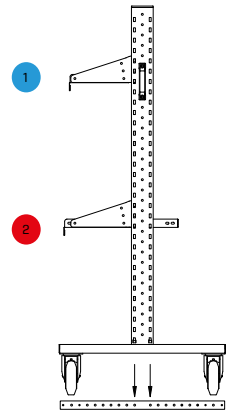
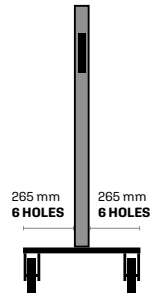

657 x 220 mm
657 x 420 mm

ATHENA box shelves

Tiltable shelf in galvanised steel - load capacity 50 kg - L = 657 mm

KIT consisting of

- Trolley 725 x 613 x 1430H mm

- 2 identical shelves complete with boxes

iMiCUBE

233

SHELF DEPTH mm	EXAMPLE	NO. OF BOXES	BOX DIMENSIONS mm			FRONT PICKING mm	MATERIAL	CODE	KIT PRICE €	CODE	PRICE OF ADDITIONAL SHELF WITH BOXES €						
			L	P	H												
220		2	300	200	120	300	PP	FXT 3212A26 5101		FX 3212A26 5101							
								FXT 3212A26 51XB		FX 3212A26 51XB							
		2	300	200	170	300	PP	FXT 3217A26 5101		FX 3217A26 5101							
								FXT 3217A26 51XB		FX 3217A26 51XB							
							PP	FXT 3217A26 5401		FX 3217A26 5401							
								FXT 3217A26 5401		FX 3217A26 5401							
420		2	400	300	120	300	PP	FXT4312A265101		FX 4312A26 5101							
								FXT 4312A26 51XB		FX 4312A26 51XB							
		2	400	300	170	300	PP	FXT 4317A26 5101		FX 4317A26 5101							
								FXT 4317A26 51XB		FX 4317A26 51XB							
							PP	FXT 4317A26 5401		FX 4317A26 5401							
								FXT 4317A26 5401		FX 4317A26 5401							
	2	400	300	220	300	PP	FXT 4322A26 5101		FX 4322A26 5101								
							FXT 4322A26 51XB		FX 4322A26 51XB								
						PP	FXT 4322A26 5401		FX 4322A26 5401								
							FXT 4322A26 5401		FX 4322A26 5401								
						1		1	600	400	120	600	PP	FXT 6412A16 5101		FX 6412A16 5101	
														FXT 6412A16 51XB		FX 6412A16 51XB	
1	600	400	170	600	PP			FXT 6417A16 5101		FX 6417A16 5101							
								FXT 6417A16 51XB		FX 6417A16 51XB							
					PP			FXT 6417A16 5401		FX 6417A16 5401							
								FXT 6417A16 5401		FX 6417A16 5401							
1	600	400	220	600	PP	FXT 6422A16 5101		FX 6422A16 5101									
						FXT 6422A16 51XB		FX 6422A16 51XB									

Load capacities are net and refer to evenly distributed loads. The accessories and the materials stored in the truck must not protrude from the base of the truck.

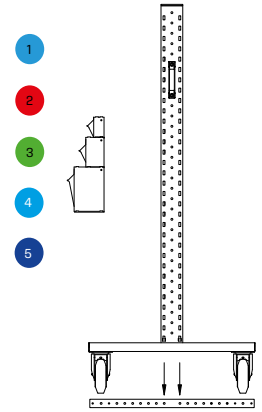
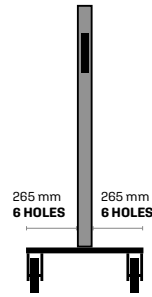

Rail total height

1200 mm - 280 mm







Usable insertion height of Practibox

1264 mm - 276 mm

KIT consisting of

- Trolley 725 x 613 x 1430H mm
- 2 pairs of rails height 1200
- 2 Practibox drawers
- 2 galvanised stops

 For each additional Practibox drawer unit, always order the relevant stops shown on page 163 position D

RAILS HEIGHT mm	PRACTIBOX RAILS				CODE	PRICE €
Total H.					FXRAIL12	
1200						
Usable H.						
1264						
Total H.					FXRAIL28	
280						
Usable H.						
276						
HEIGHT mm	PRACTIBOX DRAWER UNIT	NO. TILTING PIECES	CODE	PRICE € KIT	CODE	PRICE € ADDITIONAL PRACTIBOX
77		9	FXTPR9		PR90770001	
112		6	FXTPR6		PR61120001	
164		5	FXTPR5		PR51640001	
206		4	FXTPR4		PR42060001	
240		3	FXTPR3		PR3240001	



1MiCUBE
236

QUICK

QUICK shelf units are supplied complete with 2 shelves and Athena boxes or alternatively with 2 shelves and Compat containers.

Additional shelves complete with boxes and containers can be supplied separately.

QUICK shelf units make picking operations more efficient, reducing the frequency errors and providing high visibility of stocks.

STRUCTURE

The QUICK series shelf unit, with a height of 1817 mm, is available with two different solutions: single-sided and double-sided, allowing insertion of shelves on one or both sides.

double-sided frame with cross support



single-sided frame with cross support



iMiCUBE
237

SHELVES

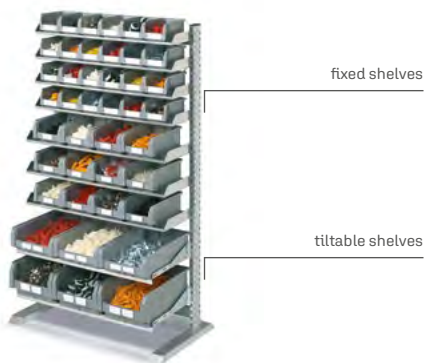

The tiltable shelves for QUICK shelf units of length 955 mm and pitch 985 mm are available in 4 depths: 220 - 320 - 420 - 600 mm.

In addition to tilted shelves, the trolley is also configurable for fixed shelves for containers, with different depths available in both cases.

BOXES AND CONTAINERS

The slots in the uprights allow the use of different types of containers including COMPAT sizes 1/2/3/3A2/4/4A2 and ATHENA series boxes.

COMPAT



ATHENA



ADDITIONAL SHELF UNITS

With additional shelves it is possible to connect a new bay to the existing one, thus saving space and the cost of an additional upright and foot.



Shelf unit dimensions

1065 x 542 mm H 1813mm

QUICK

iMiCUBE

238



Shelf dimensions

1065 x 925 mm H 1813 mm



QUICK

iMiCUBE
|
239

innovative
italian
ideas
iMilani

QUICK + COMPAT

iMiCUBE
240

Shelf unit dimensions

1065 x 542 mm H 1813mm



iMilani
innovative
italian
ideas

QUICK+COMPAT SINGLE SIDE

Shelves COMPAT containers









Fixed shelf in galvanised steel - capacity 25 kg - L = 974 mm

KIT consisting of

- Shelf unit 1065 x 542 x 1813H mm
- 2 identical shelves complete with containers

iMiCUBE

241

SHELF DEPTH mm	NO. OF CONTAINERS	CONTAINER DIMENSIONS mm			MATERIAL	CODE	KIT PRICE €	CODE	PRICE OF ADDITIONAL SHELF WITH BOXES €		
		L	P	H							
150	9	95	160/140	75		QR 00199 5101		QU 00199 5101			
						QR 00199 5102		QU 00199 5102			
		QR 00199 5103		QU 00199 5103							
		QR 00199 5104		QU 00199 5104							
		QR 00199 5105		QU 00199 5105							
		ECOGREEN 	QR 00199 5401		QU 00199 5401						
		205	6	140	230/200	130		QR 00269 5101		QU 00269 5101	
								QR 00269 5102		QU 00269 5102	
				QR 00269 5103		QU 00269 5103					
				QR 00269 5104		QU 00269 5104					
QR 00269 5105				QU 00269 5105							
ECOGREEN 	QR 00269 5401				QU 00269 5401						
295	4			200	350/300	200		QR 00349 5101		QU 00349 5101	
								QR 00349 5102		QU 00349 5102	
				QR 00349 5103		QU 00349 5103					
				QR 00349 5104		QU 00349 5104					
		QR 00349 5105		QU 00349 5105							
		ECOGREEN 	QR 00349 5401		QU 00349 5401						
		295	4	200	350/300	145		QR 3A249 5101		QU 3A249 5101	
								QR 3A249 5102		QU 3A249 5102	
				QR 3A249 5103		QU 3A249 5103					
				QR 3A249 5104		QU 3A249 5104					
QR 3A249 5105				QU 3A249 5105							
ECOGREEN 	QR 3A249 5401				QU 3A249 5401						

Load capacities are net and refer to evenly distributed loads.
The accessories and the materials stored in the truck must not protrude from the base of the truck.

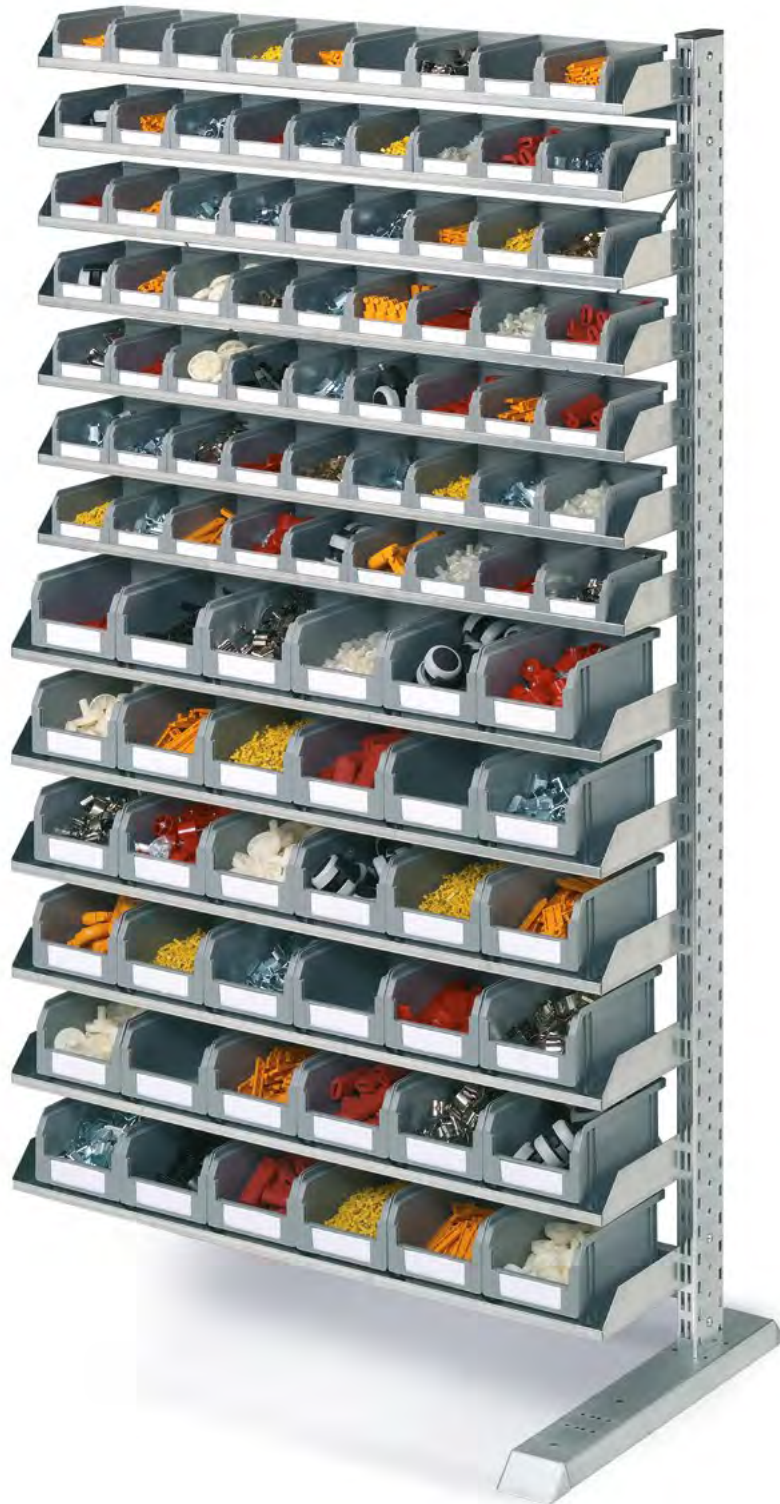

QUICK+COMPAT ADDITIONAL SINGLE SIDE

Shelves COMPAT containers













Fixed shelf in galvanised steel - capacity 25 kg - L = 974 mm

KIT consisting of

- Additional shelf unit 985 x 542 x 1813h mm
- 2 identical shelves complete with containers

iMiCUBE

243

SHELF DEPTH mm	NO. OF CONTAINERS	CONTAINER DIMENSIONS mm			MATERIAL	CODE	KIT PRICE €	CODE	PRICE OF SHELF KIT + CONTAINERS €		
		L	P	H							
150	9	95	160/140	75		QUE 00199 5101		QU 00199 5101			
						QUE 00199 5102		QU 00199 5102			
						QUE 00199 5103		QU 00199 5103			
						QUE 00199 5104		QU 00199 5104			
						QUE 00199 5105		QU 00199 5105			
		ECOGREEN 	QUE 00199 5401		QU 00199 5401						
		205	6	140	230/200	130		QUE 00269 5101		QU 00269 5101	
								QUE 00269 5102		QU 00269 5102	
								QUE 00269 5103		QU 00269 5103	
								QUE 00269 5104		QU 00269 5104	
QUE 00269 5105								QU 00269 5105			
ECOGREEN 	QUE 00269 5401				QU 00269 5401						
295	4			200	350/300	200		QUE 00349 5101		QU 00349 5101	
								QUE 00349 5102		QU 00349 5102	
								QUE 00349 5103		QU 00349 5103	
								QUE 00349 5104		QU 00349 5104	
		QUE 00349 5105						QU 00349 5105			
		ECOGREEN 	QUE 00349 5401		QU 00349 5401						
		295	4	200	350/300	145		QUE 3A249 5101		QU 3A249 5101	
								QUE 3A249 5102		QU 3A249 5102	
								QUE 3A249 5103		QU 3A249 5103	
								QUE 3A249 5104		QU 3A249 5104	
QUE 3A249 5105								QU 3A249 5105			
ECOGREEN 	QUE 3A249 5401				QU 3A249 5401						

Load capacities are net and refer to evenly distributed loads.
The accessories and the materials stored in the truck must not protrude from the base of the truck.



QUICK+ATHENA SINGLE SIDE

ATHENA box shelves

Tiltable shelf in galvanised steel - load capacity 50 kg - L = 955 mm

KIT consisting of

- Shelf unit 1065 x 542 x 1813H mm

- 2 identical shelves complete with containers

SHELF DEPTH mm	EXAMPLE	NO. OF BOXES	BOX DIMENSIONS mm			FRONT PICKING mm	MATERIAL	CODE	KIT PRICE €	CODE	PRICE OF SHELF KIT + CONTAINERS €	
			L	P	H							
220		3	300	200	120	300		QR3212A395101		QU3212A395101		
								QR3212A3951XB		QU3212A3951XB		
								QR3212A395401		QU3212A395401		
		3	300	200	170	300		QR3217A395101		QU3217A395101		
								QR3217A3951XB		QU3217A3951XB		
								QR3217A395401		QU3217A395401		
320		4	300	200	120	200		QR3212A495101		QU3212A495101		
								QR3212A4951XB		QU3212A4951XB		
								QR3212A495401		QU3212A495401		
		4	300	200	170	200		QR3217A495101		QU3217A495101		
								QR3217A4951XB		QU3217A4951XB		
								QR3217A495401		QU3217A495401		
		2	400	300	120	400		QR4312A295101		QU4312A295101		
								QR4312A2951XB		QU4312A2951XB		
								QR4312A295401		QU4312A295401		
		2	400	300	170	400		QR4317A295101		QU4317A295101		
								QR4317A2951XB		QU4317A2951XB		
								QR4317A295401		QU4317A295401		
	2	400	300	220	400		QR4322A295101		QU4322A295101			
							QR4322A2951XB		QU4322A2951XB			
							QR4322A295401		QU4322A295401			
	420		3	400	300	120	300		QR4312A395101		QU4312A395101	
									QR4312A3951XB		QU4312A3951XB	
									QR4312A395401		QU4312A395401	
3			400	300	170	300		QR4317A395101		QU4317A395101		
								QR4317A3951XB		QU4317A3951XB		
								QR4317A395401		QU4317A395401		
		3	400	300	220	300		QR4322A395101		QU4322A395101		
								QR4322A3951XB		QU4322A3951XB		
								QR4322A395401		QU4322A395401		
600		2	600	400	120	400		QR6412A295101		QU6412A295101		
								QR6412A2951XB		QU6412A2951XB		
								QR6412A295401		QU6412A295401		
		2	600	400	170	400		QR6417A295101		QU6417A295101		
								QR6417A2951XB		QU6417A2951XB		
								QR6417A295401		QU6417A295401		
		2	600	400	220	400		QR6422A295101		QU6422A295101		
								QR6422A2951XB		QU6422A2951XB		
								QR6422A295401		QU6422A295401		
		1	800	600	120	800		QR8612C195101		QU8612C195101		
								QR8612C1951XB		QU8612C1951XB		
								QR8612C195401		QU8612C195401		
	1	800	600	170	800		QR8617C195101		QU8617C195101			
							QR8617C1951XB		QU8617C1951XB			
							QR8617C195401		QU8617C195401			
	1	800	600	220	800		QR8622C195101		QU8622C195101			
							QR8622C1951XB		QU8622C1951XB			
							QR8622C195401		QU8622C195401			

Load capacities are net and refer to evenly distributed loads.
The accessories and the materials stored in the truck must not protrude from the base of the truck.



QUICK+ATHENA ADDITIONAL SINGLE SIDE

ATHENA box shelves

Tiltable shelf in galvanised steel - load capacity 50 kg - L = 955 mm

KIT consisting of

- Additional shelf unit 985 x 542 x 1813h mm
- 2 identical shelves complete with containers

SHELF DEPTH mm	EXAMPLE	NO. OF BOXES	BOX DIMENSIONS mm			FRONT PICKING mm	MATERIAL	CODE	KIT PRICE €	CODE	PRICE OF SHELF KIT + CONTAINERS €		
			L	P	H								
220		3	300	200	120	300		QUE3212A395101		QU3212A395101			
							ECOGREEN	QUE3212A3951XB		QU3212A3951XB			
		3	300	200	170	300		QUE3217A395101		QU3217A395101			
							ECOGREEN	QUE3217A3951XB		QU3217A3951XB			
		320		4	300	200	120	200		QUE3212A495101		QU3212A495101	
									ECOGREEN	QUE3212A4951XB		QU3212A4951XB	
4	300			200	170	200		QUE3217A495101		QU3217A495101			
							ECOGREEN	QUE3217A4951XB		QU3217A4951XB			
2	400			300	120	400		QUE4312A295101		QU4312A295101			
							ECOGREEN	QUE4312A2951XB		QU4312A2951XB			
2	400	300	170	400		QUE4317A295101		QU4317A295101					
					ECOGREEN	QUE4317A2951XB		QU4317A2951XB					
420		3	400	300	120	300		QUE4312A395101		QU4312A395101			
							ECOGREEN	QUE4312A3951XB		QU4312A3951XB			
		3	400	300	170	300		QUE4317A395101		QU4317A395101			
							ECOGREEN	QUE4317A3951XB		QU4317A3951XB			
		3	400	300	220	300		QUE4322A395101		QU4322A395101			
							ECOGREEN	QUE4322A3951XB		QU4322A3951XB			
600		2	600	400	120	400		QUE6412A295101		QU6412A295101			
							ECOGREEN	QUE6412A2951XB		QU6412A2951XB			
		2	600	400	170	400		QUE6417A295101		QU6417A295101			
							ECOGREEN	QUE6417A2951XB		QU6417A2951XB			
		2	600	400	220	400		QUE6422A295101		QU6422A295101			
							ECOGREEN	QUE6422A2951XB		QU6422A2951XB			
1	800	600	120	800		QUE8612C195101		QU8612C195101					
					ECOGREEN	QUE8612C1951XB		QU8612C1951XB					
1	800	600	170	800		QUE8617C195101		QU8617C195101					
					ECOGREEN	QUE8617C1951XB		QU8617C1951XB					
1	800	600	220	800		QUE8622C195101		QU8622C195101					
					ECOGREEN	QUE8622C1951XB		QU8622C1951XB					

Load capacities are net and refer to evenly distributed loads.
The accessories and the materials stored in the truck must not protrude from the base of the truck.

QUICK + COMPAT

iMiCUBE
248

Shelf unit dimensions

1065 x 925 mm H 1813mm



QUICK+COMPAT DOUBLE SIDE

Shelves COMPAT containers









Fixed shelf in galvanised steel - capacity 25 kg - L = 974 mm

KIT consisting of

- Shelf unit 1065 x 925 x 1813H mm
- 2 identical shelves complete with containers

iMiCUBE

249

SHELF DEPTH mm	NO. OF CONTAINERS	CONTAINER DIMENSIONS mm			MATERIAL	CODE	KIT PRICE €	CODE	PRICE OF SHELF KIT + CONTAINERS €		
		L	P	H							
150	9	95	160/140	75		QU2R 00199 5101		QU 00199 5101			
						QU2R 00199 5102		QU 00199 5102			
		QU2R 00199 5103		QU 00199 5103							
		QU2R 00199 5104		QU 00199 5104							
		QU2R 00199 5105		QU 00199 5105							
		ECOGREEN 	QU2R 00199 5401		QU 00199 5401						
		205	6	140	230/200	130		QU2R 00269 5101		QU 00269 5101	
								QU2R 00269 5102		QU 00269 5102	
				QU2R 00269 5103		QU 00269 5103					
				QU2R 00269 5104		QU 00269 5104					
QU2R 00269 5105				QU 00269 5105							
ECOGREEN 	QU2R 00269 5401				QU 00269 5401						
295	4			200	350/300	200		QU2R 00349 5101		QU 00349 5101	
								QU2R 00349 5102		QU 00349 5102	
				QU2R 00349 5103		QU 00349 5103					
				QU2R 00349 5104		QU 00349 5104					
		QU2R 00349 5105		QU 00349 5105							
		ECOGREEN 	QU2R 00349 5401		QU 00349 5401						
		295	4	200	350/300	145		QU2R 3A249 5101		QU 3A249 5101	
								QU2R 3A249 5102		QU 3A249 5102	
				QU2R 3A249 5103		QU 3A249 5103					
				QU2R 3A249 5104		QU 3A249 5104					
QU2R 3A249 5105				QU 3A249 5105							
ECOGREEN 	QU2R 3A249 5401				QU 3A249 5401						

Load capacities are net and refer to evenly distributed loads.
The accessories and the materials stored in the truck must not protrude from the base of the truck.

QUICK + COMPAT

iMiCUBE
250

Shelf unit dimensions

985 x 925 mm H 1813 mm

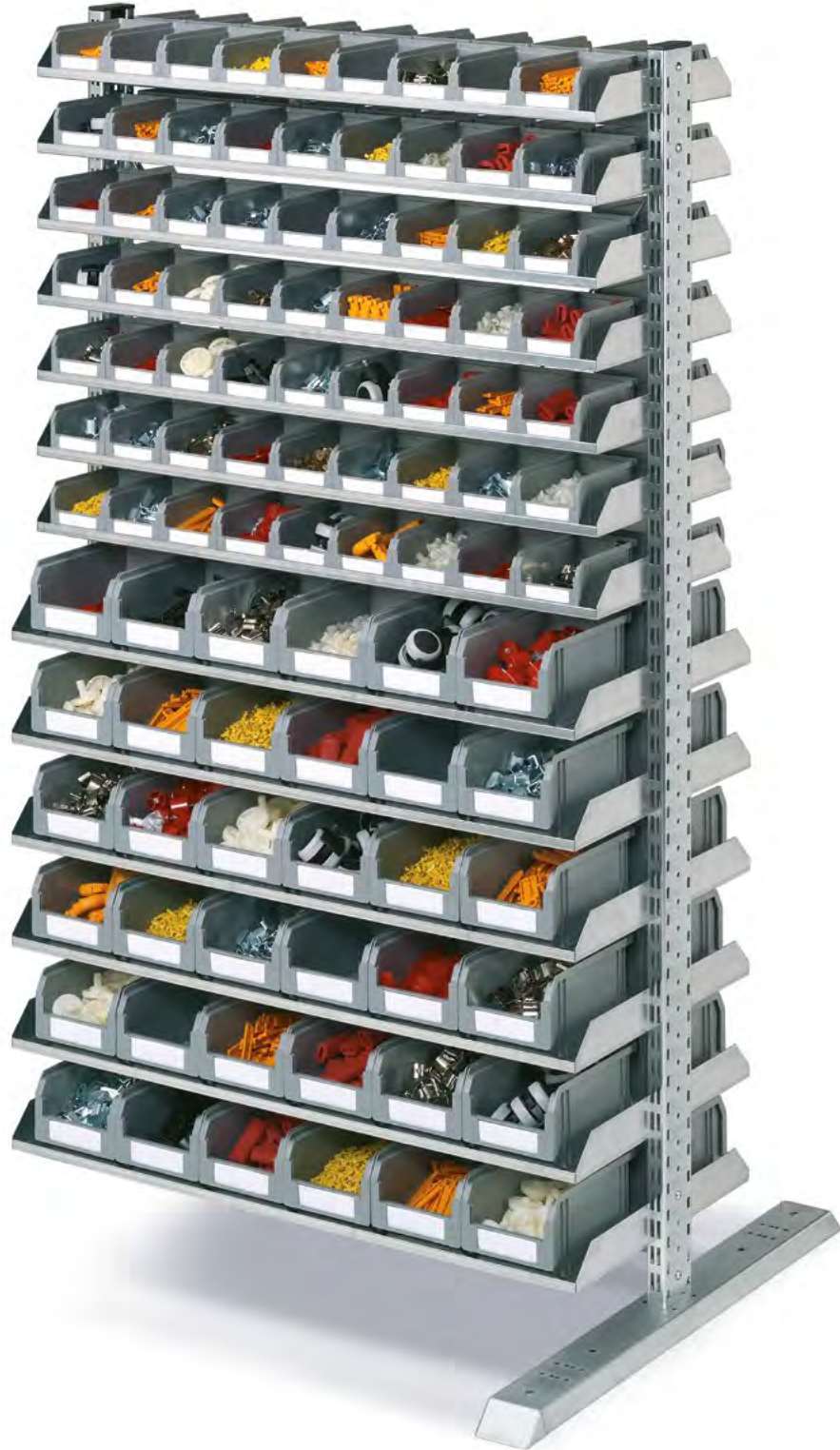

iMilani
innovative
italian
ideas

QUICK+COMPAT ADDITIONAL DOUBLE SIDE

Shelves COMPAT containers









Fixed shelf in galvanised steel - capacity 25 kg - L = 974 mm

KIT consisting of

- Additional shelf unit 985 x 925 x 1813h mm
- 2 identical shelves complete with containers

iMiCUBE

251

SHELF DEPTH mm	NO. OF CONTAINERS	CONTAINER DIMENSIONS mm			MATERIAL	CODE	KIT PRICE €	CODE	PRICE OF SHELF KIT + CONTAINERS €		
		L	P	H							
150	9	95	160/140	75		QU2E 00199 5101		QU 00199 5101			
						QU2E 00199 5102		QU 00199 5102			
		QU2E 00199 5103		QU 00199 5103							
		QU2E 00199 5104		QU 00199 5104							
		QU2E 00199 5105		QU 00199 5105							
		ECOGREEN 	QU2E 00199 5401		QU 00199 5401						
		205	6	140	230/200	130		QU2E 00269 5101		QU 00269 5101	
								QU2E 00269 5102		QU 00269 5102	
				QU2E 00269 5103		QU 00269 5103					
				QU2E 00269 5104		QU 00269 5104					
QU2E 00269 5105				QU 00269 5105							
ECOGREEN 	QU2E 00269 5401				QU 00269 5401						
295	4			200	350/300	200		QU2E 00349 5101		QU 00349 5101	
								QU2E 00349 5102		QU 00349 5102	
				QU2E 00349 5103		QU 00349 5103					
				QU2E 00349 5104		QU 00349 5104					
		QU2E 00349 5105		QU 00349 5105							
		ECOGREEN 	QU2E 00349 5401		QU 00349 5401						
		295	4	200	350/300	145		QU2E 3A249 5101		QU 3A249 5101	
								QU2E 3A249 5102		QU 3A249 5102	
				QU2E 3A249 5103		QU 3A249 5103					
				QU2E 3A249 5104		QU 3A249 5104					
QU2E 3A249 5105				QU 3A249 5105							
ECOGREEN 	QU2E 3A249 5401				QU 3A249 5401						

Load capacities are net and refer to evenly distributed loads.
The accessories and the materials stored in the truck must not protrude from the base of the truck.



QUICK+ATHENA DOUBLE SIDE

ATHENA box shelves

Tiltable shelf in galvanised steel - load capacity 50 kg - L = 955 mm

KIT consisting of

- Shelf unit 1065 x 925 x 1813H mm

- 2 identical shelves complete with containers

SHELF DEPTH mm	EXAMPLE	NO. OF BOXES	BOX DIMENSIONS mm			FRONT PICKING mm	MATERIAL	CODE	KIT PRICE €	CODE	PRICE OF SHELF KIT + CONTAINERS €
			L	P	H						
220		3	300	200	120	300		QU2R3212A395101		QU3212A395101	
								QU2R3212A3951XB		QU3212A3951XB	
		3	300	200	170	300		QU2R3217A395101		QU3217A395101	
								QU2R3217A3951XB		QU3217A3951XB	
320		4	300	200	120	200		QU2R3212A495101		QU3212A495101	
								QU2R3212A4951XB		QU3212A4951XB	
		4	300	200	170	200		QU2R3217A495101		QU3217A495101	
								QU2R3217A4951XB		QU3217A4951XB	
		2	400	300	120	400		QU2R4312A295101		QU4312A295101	
								QU2R4312A2951XB		QU4312A2951XB	
		2	400	300	170	400		QU2R4317A295101		QU4317A295101	
								QU2R4317A2951XB		QU4317A2951XB	
420		3	400	300	120	300		QU2R4312A395101		QU4312A395101	
								QU2R4312A3951XB		QU4312A3951XB	
		3	400	300	170	300		QU2R4317A395101		QU4317A395101	
								QU2R4317A3951XB		QU4317A3951XB	
		3	400	300	220	300		QU2R4322A295101		QU4322A295101	
								QU2R4322A2951XB		QU4322A2951XB	
		3	400	300	220	300		QU2R4322A395101		QU4322A395101	
								QU2R4322A3951XB		QU4322A3951XB	
600		2	600	400	120	400		QU2R6412A295101		QU6412A295101	
								QU2R6412A2951XB		QU6412A2951XB	
		2	600	400	170	400		QU2R6417A295101		QU6417A295101	
								QU2R6417A2951XB		QU6417A2951XB	
		2	600	400	220	400		QU2R6422A295101		QU6422A295101	
								QU2R6422A2951XB		QU6422A2951XB	
		1	800	600	120	800		QU2R8612C195101		QU8612C195101	
								QU2R8612C1951XB		QU8612C1951XB	
		1	800	600	170	800		QU2R8617C195101		QU8617C195101	
								QU2R8617C1951XB		QU8617C1951XB	
		1	800	600	220	800		QU2R8622C195101		QU8622C195101	
								QU2R8622C1951XB		QU8622C1951XB	
1	800	600	220	800		QU2R8622C195401		QU8622C195401			
						QU2R8622C195401		QU8622C195401			

Load capacities are net and refer to evenly distributed loads.

The accessories and the materials stored in the truck must not protrude from the base of the truck.



QUICK+ATHENA ADDITIONAL DOUBLE SIDE

ATHENA box shelves

Tiltable shelf in galvanised steel - load capacity 50 kg - L = 955 mm

KIT consisting of

- Additional shelf unit 985 x 925 x 1813h mm
- 2 identical shelves complete with containers

SHELF DEPTH mm	EXAMPLE	NO. OF BOXES	BOX DIMENSIONS mm			FRONT PICKING mm	MATERIAL	CODE	KIT PRICE €	CODE	PRICE OF SHELF KIT + CONTAINERS €
			L	P	H						
220		3	300	200	120	300		QU2E3212A395101		QU3212A395101	
								QU2E3212A3951XB		QU3212A3951XB	
		3	300	200	170	300		QU2E3217A395101		QU3217A395101	
								QU2E3217A3951XB		QU3217A3951XB	
320		4	300	200	120	200		QU2E3212A495101		QU3212A495101	
								QU2E3212A4951XB		QU3212A4951XB	
		4	300	200	170	200		QU2E3217A495101		QU3217A495101	
								QU2E3217A4951XB		QU3217A4951XB	
		2	400	300	120	400		QU2E4312A295101		QU4312A295101	
								QU2E4312A2951XB		QU4312A2951XB	
		2	400	300	170	400		QU2E4317A295101		QU4317A295101	
								QU2E4317A2951XB		QU4317A2951XB	
420		3	400	300	120	300		QU2E4312A395101		QU4312A395101	
								QU2E4312A3951XB		QU4312A3951XB	
		3	400	300	170	300		QU2E4317A395101		QU4317A395101	
								QU2E4317A3951XB		QU4317A3951XB	
		3	400	300	220	300		QU2E4322A395101		QU4322A395101	
								QU2E4322A3951XB		QU4322A3951XB	
600		2	600	400	120	400		QU2E6412A295101		QU6412A295101	
								QU2E6412A2951XB		QU6412A2951XB	
		2	600	400	170	400		QU2E6417A295101		QU6417A295101	
								QU2E6417A2951XB		QU6417A2951XB	
		2	600	400	220	400		QU2E6422A295101		QU6422A295101	
								QU2E6422A2951XB		QU6422A2951XB	
		1	800	600	120	800		QU2E8612C195101		QU8612C195101	
								QU2E8612C1951XB		QU8612C1951XB	
		1	800	600	170	800		QU2E8617C195101		QU8617C195101	
								QU2E8617C1951XB		QU8617C1951XB	
1	800	600	220	800		QU2E8622C195101		QU8622C195101			
						QU2E8622C1951XB		QU8622C1951XB			

Load capacities are net and refer to evenly distributed loads.
The accessories and the materials stored in the truck must not protrude from the base of the truck.



iMiCUBE
256

FRAME

The FRAME shelf unit is precisely sized to house Athena, Athena Light, Kronos, Odette, Compat and Zeus boxes.

There are two available heights: 1010 mm and 2010 mm.

The paired guides that support the box container are adjustable in height and have a pitch of 25 mm and maximum load capacity of 50 kg; boxes and

containers of the same width but with different depths and heights can be inserted in the same bay. The load capacity of the bay is 250 kg.

The modularity of the system allows the existing systems to be extended at any time without removal of the existing one.

UPPER SUPPORT SURFACE

The surfaces are fixed to the top of each bay and, as well as strengthening the shelf unit, act as dust covers and bearing surfaces.



iMiCUBE

257

SHELVES

The guides for the sliding of the boxes are fastened to the uprights and secured using the attachment clip. Adjustable height with 25 mm pitch.



SIDES

The sides are supplied mounted and have a lateral fissure with a pitch of 25 mm and are complete with legs for fixing to the ground. Load capacity 250 kg.



PAIR OF RETAINING BRACKETS

The brackets are fixed to the sides of the uprights with four self-tapping screws to make the structure more stable.



Depth

400 mm

FRAME

iMiCUBE
258

Dimensions of this composition 1440x400x2010H mm



Front picking 300 mm
Depth 400 mm



Athena



Kronos



Odette



R-KLT



RL-KLT

Depth

400 mm

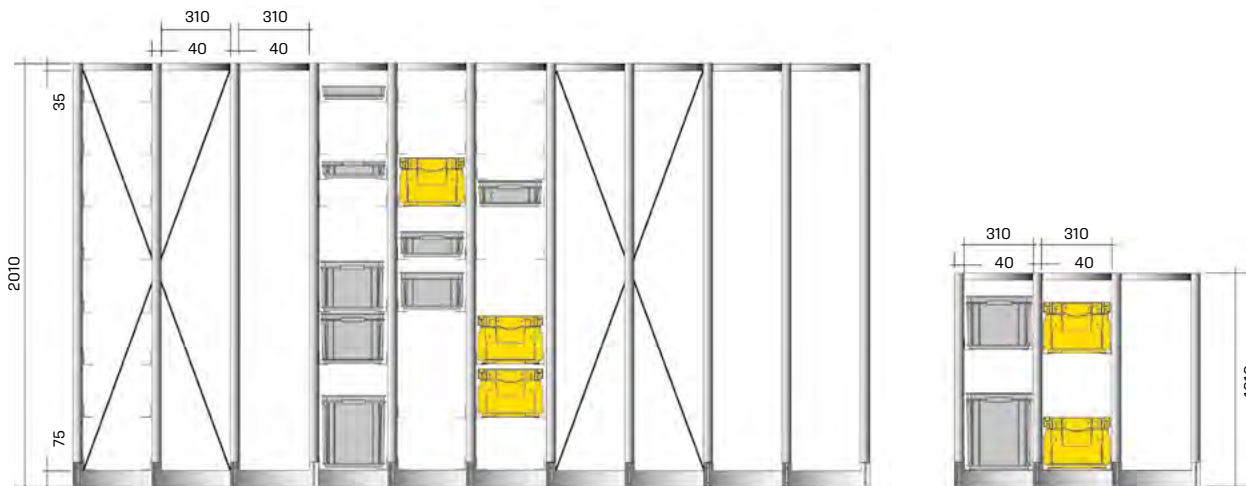

FRAME

iMiCUBE
|
259

DOUBLE BAY BASE WITH CROSS SUPPORT 2010 H	ADDITIONAL SINGLE BAY 2010 H	CROSS SUPPORT	SINGLE BAY BASE 1010 H	ADDITIONAL SINGLE BAY 1010 H	GALVANISED PAIR OF GUIDES	PAIR OF ANCHOR BOLTS M8X75
250 kg LOAD CAPACITY PER BAY	250 kg LOAD CAPACITY PER BAY	1 CROSS SUPPORT EVERY 6 SINGLE BAYS	250 kg LOAD CAPACITY PER BAY	250 kg LOAD CAPACITY PER BAY	50 kg LOAD CAPACITY PER PAIR OF GUIDES	REQUIREMENT FOR FIXING TO GROUND
USABLE INSERTION HEIGHT 1900 mm - GUIDE PITCH H 25 mm	USABLE INSERTION HEIGHT 1900 mm - GUIDE PITCH H 25 mm		USABLE INSERTION HEIGHT 900 mm - GUIDE PITCH H 25 mm	USABLE INSERTION HEIGHT 900 mm - GUIDE PITCH H 25 mm	REAR END STOP	
FR2004099	FRE2004099	FRCROSS	FR1004099	FRE1004099	FRRAIL40	FRFIX

Note: fixing material consisting of 2 M8x75 mm expansion screws in steel for uncracked concrete floors equal to or greater than C20/25 class.

BOX HEIGHT	GUIDE PITCH HEIGHT	ATHENA	KRONOS	ODETTE	R-KLT	RL-KLT
55	75	■				
78	100	■				
120	150	■				
147	175			■	■	■
170	200	■				
220	250	■	■			
280	300				■	■
320	350	■				

Depth

600 mm

FRAME

iMiCUBE
260

Dimensions of this composition 1390x600x2010H mm



Front picking 400 mm
Depth 600 mm



Athena



Athena Light



Kronos



Odette



R-KLT



RL-KLT

Depth

600 mm

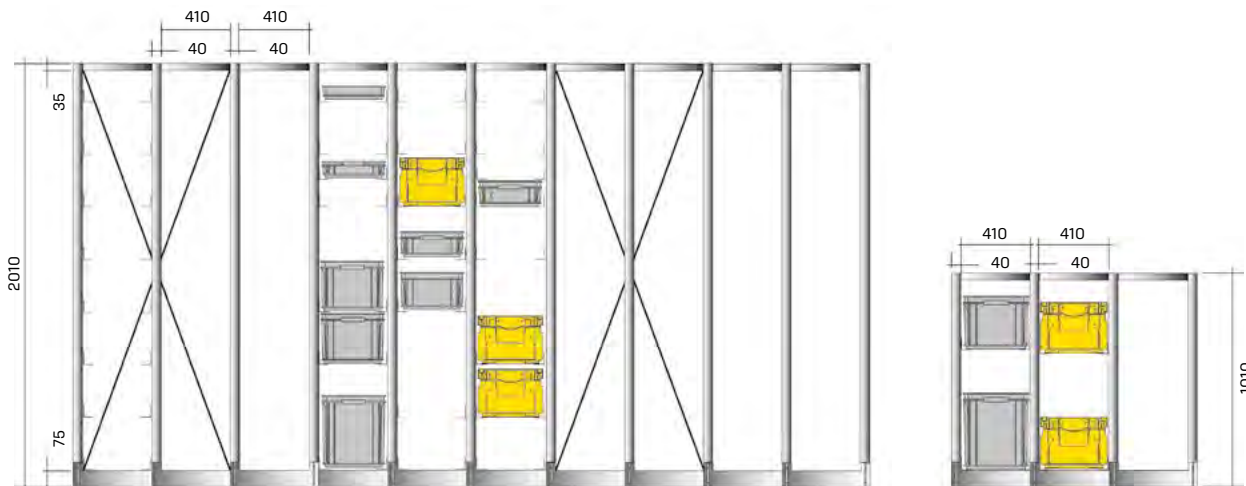

FRAME

iMiCUBE
|
261

DOUBLE BAY BASE WITH CROSS SUPPORT 2010 H	ADDITIONAL SINGLE BAY 2010 H	CROSS SUPPORT	SINGLE BAY BASE 1010 H	ADDITIONAL SINGLE BAY 1010 H	GALVANISED PAIR OF GUIDES	PAIR OF ANCHOR BOLTS M8X75
250 kg LOAD CAPACITY PER BAY	250 kg LOAD CAPACITY PER BAY	1 CROSS SUPPORT EVERY 6 SINGLE BAYS	250 kg LOAD CAPACITY PER BAY	250 kg LOAD CAPACITY PER BAY	50 kg LOAD CAPACITY PER PAIR OF GUIDES	REQUIREMENT FOR FIXING TO GROUND
USABLE INSERTION HEIGHT 1900 mm - GUIDE PITCH H 25 mm	USABLE INSERTION HEIGHT 1900 mm - GUIDE PITCH H 25 mm		USABLE INSERTION HEIGHT 900 mm - GUIDE PITCH H 25 mm	USABLE INSERTION HEIGHT 900 mm - GUIDE PITCH H 25 mm	REAR END STOP	
FR2006099	FRE2006099	FRCROSS	FR1006099	FRE1006099	FRRAIL60	FRFIX

Note: fixing material consisting of 2 M8x75 mm expansion screws in steel for uncracked concrete floors equal to or greater than C20/25 class.

BOX HEIGHT	GUIDE PITCH HEIGHT	ATHENA	ATHENA LIGHT	KRONOS	ODETTE	R-KLT	RL-KLT
78	100	■					
120	150	■					
147	175					■	■
170	200	■					
220	250	■	■	■	■		
280	300	■				■	■
320	350	■		■	■		
430	450	■					

Depth

350 mm

FRAME

iMiCUBE
262

Dimensions of this composition 1355x350x2010H mm



Front picking 200 mm
Depth 350 mm



Compact



Zeus

Depth

350 mm

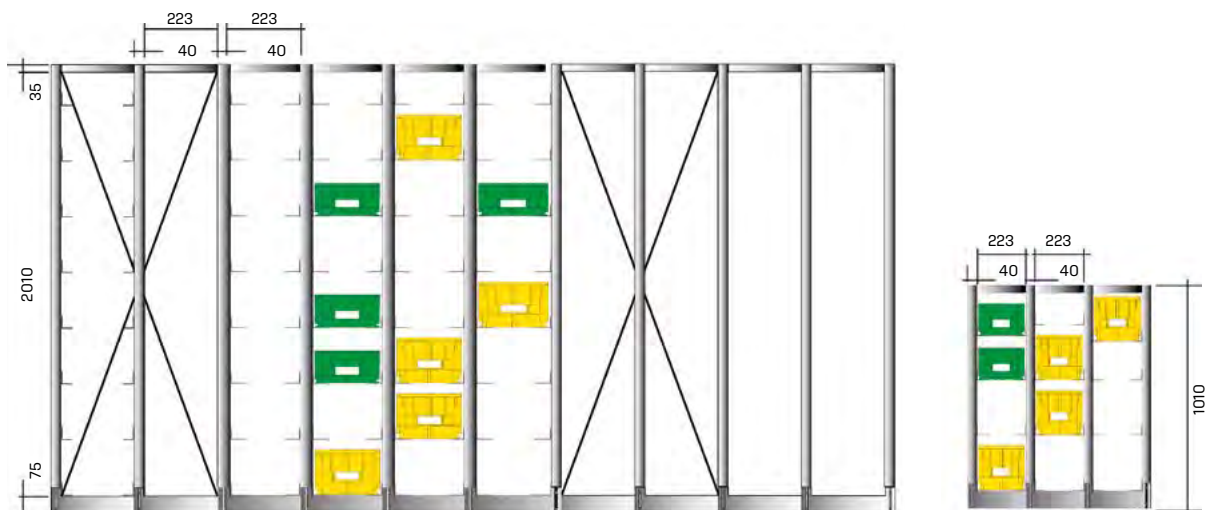

FRAME

iMiCUBE
|
263

DOUBLE BAY BASE WITH CROSS SUPPORT 2010 H	ADDITIONAL SINGLE BAY 2010 H	CROSS SUPPORT	SINGLE BAY BASE 1010 H	ADDITIONAL SINGLE BAY 1010 H	GALVANISED PAIR OF GUIDES	PAIR OF ANCHOR BOLTS M8X75
250 kg LOAD CAPACITY PER BAY	250 kg LOAD CAPACITY PER BAY	1 CROSS SUPPORT EVERY 6 SINGLE BAYS	250 kg LOAD CAPACITY PER BAY	250 kg LOAD CAPACITY PER BAY	50 kg LOAD CAPACITY PER PAIR OF GUIDES	REQUIREMENT FOR FIXING TO GROUND
USABLE INSERTION HEIGHT 1900 mm - GUIDE PITCH H 25 mm	USABLE INSERTION HEIGHT 1900 mm - GUIDE PITCH H 25 mm		USABLE INSERTION HEIGHT 900 mm - GUIDE PITCH H 25 mm	USABLE INSERTION HEIGHT 900 mm - GUIDE PITCH H 25 mm	REAR END STOP	
FR2003599	FRE2003599	FRCROSS	FR1003599	FRE1003599	FRRAIL35	FRFIX

Note: fixing material consisting of 2 M8x75 mm expansion screws in steel for uncracked concrete floors equal to or greater than C20/25 class.

BOX HEIGHT	GUIDE PITCH HEIGHT	COMPAT	ZEUS
145	175	■	■
200	225	■	

innovative
italian
ideas
iMilani

Depth

500 mm

FRAME

iMiCUBE
264

Dimensions of this composition 1492x500x2010H mm



Front picking 300 mm
Depth 500 mm



Compact



Zeus

Depth

500 mm

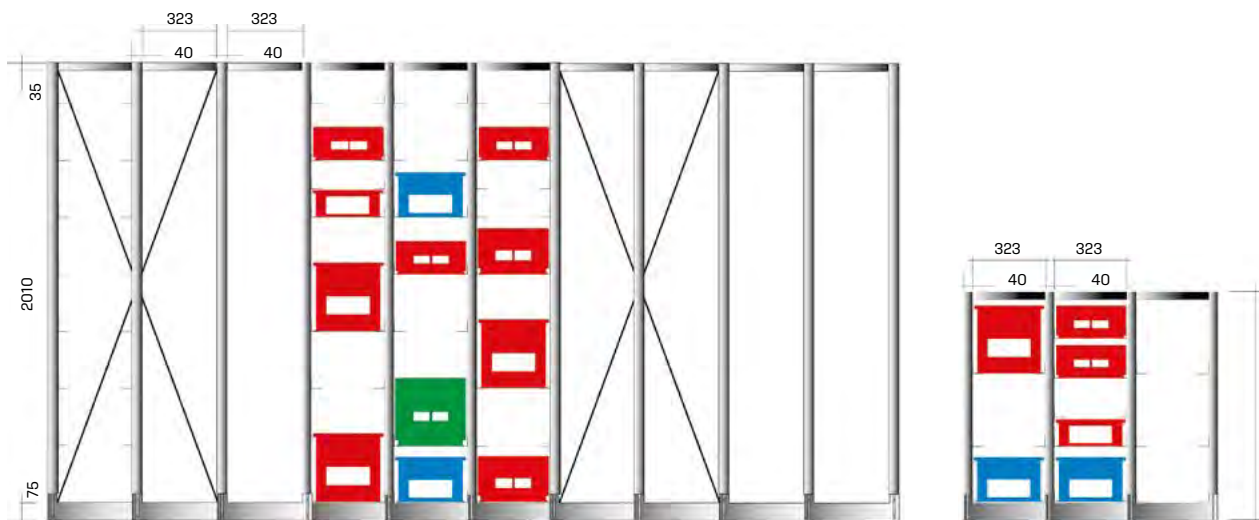

FRAME

iMiCUBE
|
265

DOUBLE BAY BASE WITH CROSS SUPPORT 2010 H	ADDITIONAL SINGLE BAY 2010 H	CROSS SUPPORT	SINGLE BAY BASE 1010 H	ADDITIONAL SINGLE BAY 1010 H	GALVANISED PAIR OF GUIDES	PAIR OF ANCHOR BOLTS M8x75
250 kg LOAD CAPACITY PER BAY	250 kg LOAD CAPACITY PER BAY	1 CROSS SUPPORT EVERY 6 SINGLE BAYS	250 kg LOAD CAPACITY PER BAY	250 kg LOAD CAPACITY PER BAY	50 kg LOAD CAPACITY PER PAIR OF GUIDES	REQUIREMENT FOR FIXING TO GROUND
USABLE INSERTION HEIGHT 1900 mm - GUIDE PITCH H 25 mm	USABLE INSERTION HEIGHT 1900 mm - GUIDE PITCH H 25 mm		USABLE INSERTION HEIGHT 900 mm - GUIDE PITCH H 25 mm	USABLE INSERTION HEIGHT 900 mm - GUIDE PITCH H 25 mm	REAR END STOP	
FR2005099	FRE2005099	FRCROSS	FR1005099	FRE1005099	FRRAIL50	FRFIX

Note: fixing material consisting of 2 M8x75 mm expansion screws in steel for uncracked concrete floors equal to or greater than C20/25 class.

BOX HEIGHT	GUIDE PITCH HEIGHT	COMPAT	ZEUS
120	150		■
145	175	■	
200	225	■	■
300	325	■	■

PICK

PICK container holder cabinets are the ideal commercial and industrial storage solution for small parts and small items.

They consist of a steel sheet structure with height-adjustable shelves, which can be variable in number according to the user's needs.

They are compatible for insertion of Compat containers series size 1 or 2 and Practibox container series, from 3 to 9 tilting.

These cabinets can be supplied without door or with door and lock.

ADJUSTABLE SHELVES

The cabinet can be partitioned with height-adjustable shelves, 25 mm in pitch, with insertion of as many shelves as needed.

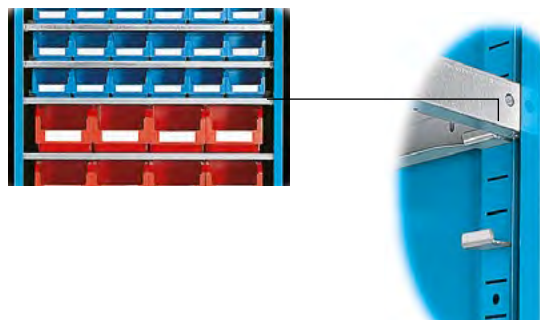

iMiCUBE
267

CONTAINERS

The PICK cabinets can be fitted with Compat series containers in sizes 1 and 2, as well as the Practibox tilting drawer unit series, numbers 3 - 4 - 5 - 6 - 9.

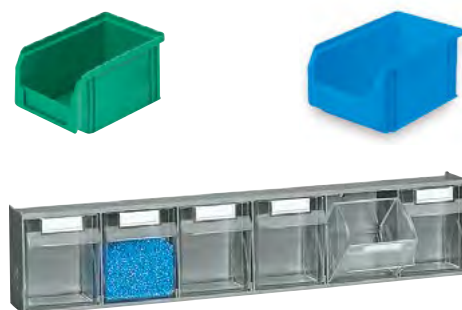

REAR STOP

A rear stop can be applied to the shelf to prevent the depthways displacement of container size 1

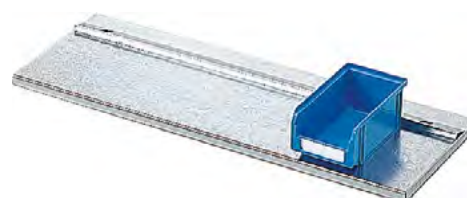

SAFETY

For safety purposes, PICK container holder cabinets must be fixed to the floor or wall.



Some examples of compositions possible with PICK 100 cabinets

iMiCUBE
268

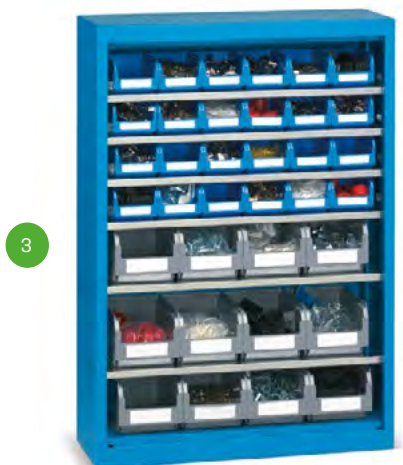

700 x 270 H 1000 mm



Cabinet load capacity 450 kg.

Cabinet available in the following colours:

iMiCUBE
269

- grey RAL7000** - code 01
- green RAL6011** - code 02
- blue RAL5012** - code 04
- grey RAL7035** - code 08

Other colours available on request.

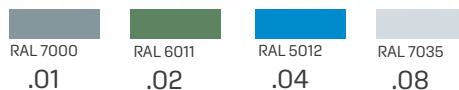

Comp.	Hinged doors	Lock	Shelves	Compat size 1	Stops for containers	Compat size 2	Shelf load capacity kg	Cabinet colour	Article	Price €
1			8	54	9		50	blue 04	PK10001 04	
2	■	■	8	54	9		50	blue 04	PK10011 04	
3			6	24	4	12	50	blue 04	PK10002 04	
4	■	■	6	24	4	12	50	blue 04	PK10012 04	
5			5			24	50	blue 04	PK10003 04	
6	■	■	5			24	50	blue 04	PK10013 04	

⚠ Safety: for safety purposes, the container holder cabinets must be fixed to the floor or wall.

Some examples of compositions possible with PICK 165 cabinets

iMiCUBE
270

1



2



3



700 x 270 H 1655 mm



Cabinet load capacity 500 kg.

Cabinet available in the following colours:

- grey RAL7000** - code 01
- green RAL6011** - code 02
- blue RAL5012** - code 04
- grey RAL7035** - code 08

Other colours available on request.

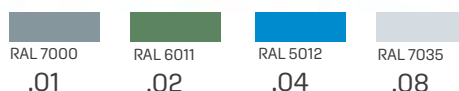

Comp.	Hinged doors	Lock	Shelves	Compat size 1	Stops for containers	Compat size 2	Shelf load capacity kg	Cabinet colour	Article	Price €
1			12	42	7	24	50	blue 04	PK 16501 04	
2	■	■	12	42	7	24	50	blue 04	PK 16511 04	
Comp.	Hinged doors	Lock	Practibox holder frame	Practibox PR 9077...	Practibox PR 6112...	Practibox PR 5164...	Practibox PR 4206...	Practibox PR 3240...	Article	Price €
3	■	■	1x1500H	2	4	3	1	1	PK 16512 04	

⚠ Safety: for safety purposes, the container holder cabinets must be fixed to the floor or wall.

Some examples of compositions possible with PICK 200 cabinets

iMiCUBE
272

1



2



3



700 x 270 H 2000 mm



Cabinet load capacity 500 kg.

Cabinet available in the following colours:

- grey RAL7000** - code 01
- green RAL6011** - code 02
- blue RAL5012** - code 04
- grey RAL7035** - code 08

Other colours available on request.

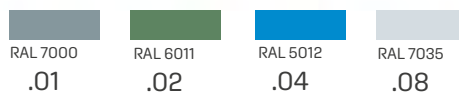

Comp.	Hinged doors	Lock	Shelves	Compat size 1	Stops for containers	Compat size 2	Shelf load capacity kg	Cabinet colour	Article	Price €
1			15	54	9	28	50	blue 04	PK 20001 04	
2	■	■	15	54	9	28	50	blue 04	PK 20011 04	
Comp.	Hinged doors	Lock	Practibox holder frame	Practibox PR 9077...	Practibox PR 6112...	Practibox PR 5164...	Practibox PR 4206...	Practibox PR 3240...	Article	Price €
3	■	■	1x1750H	1	6	2	2	1	PK 20012 04	

⚠ Safety: for safety purposes, the container holder cabinets must be fixed to the floor or wall.

Empty cabinets for other configurations

1



H 1000 mm

2



3



H 1650 mm

4



5



H 2000 mm

6



700 x 270 H 1000/1650/2000 mm

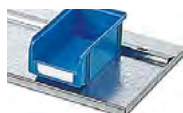

When size 1 containers are inserted, the stop bracket on the shelf must be used.
Art. PK STOP -



Galvanised steel shelf, complete with 4 hooks
Art. PK SHELF -

iMiCUBE
275

PICK

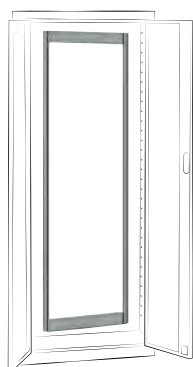

Practibox holder frame for cabinets 2000 mm in height, including fixing screws
Art. PK FR20 01 -

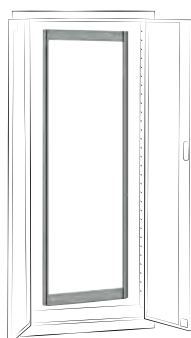

Practibox holder frame for cabinets 1650 mm in height, including fixing screws
Art. PK FR16 01 -

Cabinet load capacity 500 kg.

Cabinet available in the following colours:

- grey RAL7000** - code 01
- green RAL6011** - code 02
- blue RAL5012** - code 04
- grey RAL7035** - code 08

Other colours available on request.



2 HILTI anchor bolts suitable for uncracked concrete floors greater than or equal to C20/25 class
Recommended anchor bolt traction: 2.9 KN
Anchor bolt diameter: Ø 6 mm
Art. PK FIX -

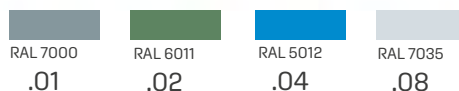

Comp.	Hinged doors	Lock	Shelves	Compat size1	Stops for containers	Compat size 2	Load capacity of shelf kg	Cabinet colour	Article	Price €
1								blue 04	PK 10000 04	
2	■	■						blue 04	PK 10010 04	
3								blue 04	PK 16500 04	
4	■	■						blue 04	PK 16510 04	
5								blue 04	PK 20000 04	
6	■	■						blue 04	PK 20010 04	

⚠ Safety: for safety purposes, the container holder cabinets must be fixed to the floor or wall.

SQUARE

SQUARE shelf units are stackable and can be used to create complete wall shelving installations units, in accordance with available space.

SQUARE shelf units consist of steel structures in RAL7000 grey colour and 8 different configurations, for Zeus series boxes and Compat series containers.

The warehouse configurations of SQUARE shelf units can be easily modified since the individual compositions are monobloc structures – a solution that not only allows for rapid preparation of the area, but also imparts considerable strength even at full load.

DUST PROTECTION COVER

Use of the dust cover also protects the material from accidental loads.

Constructed in RAL7000 grey steel.



WORKTOP

The worktop allows the creation of comfortable, practical workstations for the distribution of materials.

Constructed in RAL7000 grey steel.



PLINTH

The plinth raises the shelf unit 85 mm from the ground, insulates it from the floor and prevents the bottom row of boxes/containers from touching the ground during extraction.

Constructed in RAL7000 grey steel.



CONTAINERS

Individual boxes/containers can be extracted easily and quickly and a special hook positioned at the front on the guides prevents total or accidental ejection.



size 3



size 4A5



size 272-4



size 272-4A5



size 4



size 5



size 272-5

COMPAT

ZEUS

iMiCUBE
278



size 3

1



1025 x 310 x 885H mm

2



1765 x 310 x 885H mm

3



1075 x 460 x 885H mm

4



1765 x 460 x 885H mm



size 4



size 272-4

5



1765 x 460 x 1300H mm



size 4A5



size 272-4A5

6



1765 x 460 x 1300H mm



size 5

7



1125 x 660 x 1180H mm

8



1670 x 660 x 1180H mm



size 272-5

FRAME STACKABILITY

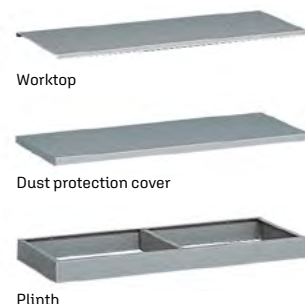
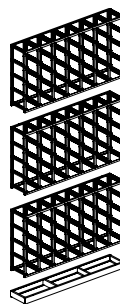

Frame		Single frame load capacity kg	Box load capacity kg	Number of boxes / containers	Price € excluding containers	Frame		Single frame load capacity kg	Box load capacity kg	Number of boxes / containers	Price € excluding containers		
1	1 frame	960	60	16		5	1 frame	2400	80	30			
	SQ16003	2 frames stacked	960				60	SQ30004	2 frames stacked			2400	80
	3 frames stacked	640	40				SQ30004	3 frames stacked	1500			50	
SQB1023	Plinth	1020 x 315 x 85H mm				SQB1764	Plinth	1765 x 465 x 85H mm					
SQC1023	Dust protection cover	1020 X 315 x 20H mm				SQC1764	Dust protection cover	1765 x 465 x 20H mm					
SQW1023	Worktop	1025 x 315 x 32H mm				SQW1774	Worktop	1770 x 465 x 32H mm					
2	1 frame	1680	60	28		6	1 frame	1600	80	20			
	SQ28003	2 frames stacked	1680				60	SQ204A5	2 frames stacked			1000	80
	3 frames stacked	1120	40				SQ204A5	3 frames stacked	1000			50	
SQB1763	Plinth	1765 x 315 x 85H mm				SQB1764	Plinth	1765 x 465 x 85H mm					
SQC1763	Dust protection cover	1765 x 315 x 20H mm				SQC1764	Dust protection cover	1765 x 465 x 20H mm					
SQW1773	Worktop	1770 x 315 x 32H mm				SQW1774	Worktop	1770 x 465 x 32H mm					
3	1 frame	1200	100	12		7	1 frame	1200	200	6			
	SQ12004	2 frames stacked	1200				100	SQ06005	2 frames stacked			1200	200
	3 frames stacked	1200	100				SQ06005	3 frames stacked	1200			200	
SQB1074	Plinth	1070 x 465 x 85H mm				SQB1126	Plinth	1125 x 660 x 155H mm					
SQC1074	Dust protection cover	1070 x 465 x 20H mm				SQC1126	Dust protection cover	1120 x 665 x 30H mm					
SQW1074	Worktop	1075 x 465 x 32H mm											
4	1 frame	1600	80	20		8	1 frame	1800	200	9			
	SQ20004	2 frames stacked	1600				80	SQ09005	2 frames stacked			1800	200
	3 frames stacked	160	80				SQ09005	3 frames stacked	1800			200	
SQB1764	Plinth	1765 x 465 x 85H mm				SQB1676	Plinth	1670 x 660 x 155H mm					
SQC1764	Dust protection cover	1765 x 465 x 20H mm				SQC1666	Dust protection cover	1667 x 665 x 30H mm					
SQW1774	Worktop	1770 x 465 x 32H mm											

GENERAL TERMS AND CONDITIONS OF SALE FOR IMLANI PRODUCTS

1. DEFINITIONS

- 1.1 WITHIN THIS AGREEMENT, THE TERMS SPECIFIED BELOW SHALL HAVE THE FOLLOWING MEANING:
- A) BUYER: ANY TRADER WHO PURCHASES OR PROPOSES TO PURCHASE FROM IMLANI THE PRODUCTS MARKETED BY IMLANI;
- B) ORDER CONFIRMATION: REFERS TO THE DOCUMENT WITH WHICH IMLANI ACCEPTS A PROPOSAL;
- C) INCOTERMS2010: INCOTERMS OF THE INTERNATIONAL CHAMBER OF COMMERCE, IN THE TEXT IN FORCE AT THE DATE OF FINALISING THE ORDER;
- D) ORDER(S): MEANS THE CONTRACT, FORMED BY THE PROPOSAL SUBMITTED BY THE BUYER AND THE ORDER CONFIRMATION ISSUED BY IMLANI, WHICH REGULATES THE SUPPLY OF PRODUCTS;
- E) PARTS: IMLANI AND THE BUYER;
- F) PRODUCTS: GOODS COVERED BY A SALE OR SALE NEGOTIATION;
- G) PROPOSAL(S): THE REQUEST(S) TO PURCHASE THE PRODUCTS SENT BY THE BUYER TO IMLANI.

2. FIELD OF APPLICATION

- 2.1 THESE CONDITIONS OF SALE (HEREINAFTER THE "CONDITIONS") APPLY BETWEEN IMLANI SRL (HEREINAFTER "IMLANI") AND THE BUYER EVEN WHEN THEY HAVE NOT BEEN AGREED UPON OR REFERRED TO BY THE PARTIES.
- 2.2 ANY EXCEPTIONS SHALL BE VALID ONLY IF CONTAINED IN SEPARATE DOCUMENTS SIGNED BY THE PARTIES.
- 2.3 THE GENERAL TERMS AND CONDITIONS OF SALE ARE AN INTEGRAL PART OF ALL ORDERS, INCLUDING WHEN FINALISED BY TELEPHONE, VERBALLY, BY FAX, EMAIL OR INTERNET.
- 2.4 IN THE EVENT OF DISCREPANCIES BETWEEN THE PROVISIONS REFERRED TO HEREIN AND THOSE CONTAINED IN THE ORDER, THE LATTER SHALL IN ANY CASE PREVAIL.

3. FINALISATION OF THE ORDER

- 3.1 THE BUYER MAY SUBMIT PROPOSALS TO IMLANI EITHER DIRECTLY OR THROUGH AGENTS AND THEIR REPRESENTATIVES. HOWEVER, AN ORDER SHALL BE FINALISED ONLY AFTER AN ORDER CONFIRMATION HAS BEEN SENT BY IMLANI FOR EACH INDIVIDUAL PROPOSAL.
- 3.2 IMLANI EXPRESSLY RESERVES THE RIGHT TO EVALUATE ANY PROPOSAL AND SHALL NOT BE BOUND TO THE ACCEPTANCE THEREOF.
- 3.3 ANY SUPPLY OFFERS FROM IMLANI TO THE BUYER SHALL ONLY BE CONSIDERED FIRM AND IRREVOCABLE IF QUALIFIED AS SUCH IN WRITING BY IMLANI.
- 3.4 THE REGISTERED OFFICES OF IMLANI SHALL ALWAYS BE THE PLACE OF FINALISATION OF THE ORDER, INCLUDING ORDERS THAT ARE FINALISED ELECTRONICALLY.

4. DELIVERY TERMS

- 4.1 IMLANI SHALL DELIVER THE PRODUCTS EX-WORKS (EXW INCOTERMS2010). IF REQUESTED, IMLANI SHALL TAKE CARE OF THE TRANSPORTATION OF THE PRODUCTS, AT THE RISK, COST AND EXPENSE OF THE BUYER. THE PAYMENT OF TRANSPORT COSTS BY IMLANI SHALL NOT AFFECT THE RISKS OF THE SHIPMENT, WHICH SHALL CONTINUE TO BE BORNE BY THE BUYER AT THE LATEST UPON DELIVERY OF THE PRODUCTS TO THE FIRST CARRIER.
- 4.2 THE DELIVERY OF THE PRODUCTS MUST TAKE PLACE BY THE DEADLINE SPECIFIED IN THE ORDER, CALCULATED IN WORKING DAYS. HOWEVER, THE DELIVERY DEADLINE IS PURELY INDICATIVE AND IS NOT AN ESSENTIAL TERM OF THE CONTRACT AND, IN ANY CASE, DOES NOT INCLUDE TRANSPORT TIME.
- 4.3 UPON RECEIPT OF THE NOTICE OF GOODS READY FOR PICK-UP, THE BUYER MUST COLLECT THE PRODUCTS WITHIN A DEADLINE OF 10 (TEN) DAYS. SHOULD THE BUYER DEFAULT, THE PRODUCTS MAY BE STORED OUTDOORS, WITH IMLANI RELEASED FROM ANY LIABILITY, AND ALL GUARANTEES BEING FORFEITED IN FAVOUR OF IMLANI; THE BUYER SHALL BE CHARGED FOR ANY HANDLING AND STORAGE COSTS INCURRED BY IMLANI, WHICH MAY ALSO, AT ITS DISCRETION, HAVE THE PRODUCTS PLACED IN STORAGE AT THE BUYER'S EXPENSE.
- 4.4 IMLANI SHALL BE ENTITLED TO ISSUE A REGULAR INVOICE WITHIN 10 (TEN) DAYS FROM THE NOTICE OF GOODS READY FOR PICK UP.

5. COMPLAINTS

- 5.1 ANY COMPLAINTS REGARDING THE PACKAGING CONDITION, QUANTITY, NUMBER OR EXTERNAL CHARACTERISTICS OF THE PRODUCTS (APPARENT DEFECTS) MUST BE SUBMITTED TO IMLANI IN WRITING, UNDER PENALTY OF FORFEITURE, WITHIN 8 (EIGHT) BUSINESS DAYS FROM THE DATE OF RECEIPT OF THE PRODUCTS.
- 5.2 ANY COMPLAINTS RELATING TO DEFECTS THAT CANNOT BE IDENTIFIED THROUGH DILIGENT CONTROL UPON RECEIPT (HIDDEN DEFECTS) MUST BE SUBMITTED TO IMLANI, UNDER PENALTY OF FORFEITURE, WITHIN 8 (EIGHT) DAYS FROM THE DATE OF DISCOVERY OF THE DEFECT AND REPORTED TO IMLANI IN THE MANNER PROVIDED UNDER THE WARRANTY CONDITIONS.
- 5.3 IN NO CASE SHALL AGENTS, CUSTOMERS OR INTERMEDIARIES OF IMLANI HAVE THE POWER TO REPRESENT IMLANI OR TAKE ANY BINDING OBLIGATIONS ON BEHALF OF IMLANI VIS À VIS THE BUYER OR OTHER THIRD PARTIES. TO THIS END, ANY NOTICE RELATING TO FAULTS OR DEFECTS OF THE PRODUCTS SHALL BE INVALID AND INEFFECTIVE IF MADE TO AGENTS, CUSTOMERS OR INTERMEDIARIES OF IMLANI.

6. PRICES

- 6.1 THE PRICES OF THE PRODUCTS SHALL BE THOSE SPECIFIED IN THE IMLANI PRICE LIST IN FORCE AT THE TIME THE ORDER IS FINALISED OR, IF THE PRODUCT IS NOT INCLUDED IN THE PRICE LIST OR THE PRICE LIST IS NOT AVAILABLE, THOSE SPECIFIED IN THE ORDER CONFIRMATION.
- 6.2 UNLESS OTHERWISE AGREED, THE AFOREMENTIONED PRICES SHALL BE CALCULATED EX WORKS (EXW INCOTERMS2010). THESE PRICES DO NOT INCLUDE THE COSTS OF SPECIAL PACKAGING, SHIPPING AND TRANSPORT FROM IMLANI'S PREMISES, WHICH SHALL BE BORNE BY THE BUYER. UNLESS OTHERWISE AGREED, THE BUYER SHALL ALSO BEAR ALL EXPENSES, TAXES OR DUTIES INHERENT IN THE SALE OF THE PRODUCTS, INCLUDING THE COSTS OF ALL CUSTOMS FORMALITIES (AS WELL AS ANY DUTIES, TAXES AND OTHER OFFICIAL CHARGES TO BE PAID FOR EXPORTING THE PRODUCTS).

7. PAYMENT CONDITIONS

- 7.1 WHERE THE TERMS OF PAYMENT ARE NOT SPECIFIED IN THE ORDER, THE PAYMENT MUST BE MADE WITHIN 30 DAYS FROM THE END OF MONTH INVOICE DATE, BY BANK TRANSFER. THE PAYMENT SHALL BE CONSIDERED PAID MADE WHEN THE SUM BECOMES AVAILABLE TO IMLANI AT ITS BANK IN ITALY.
- 7.2 IF THE PARTIES AGREED ON AN ADVANCE PAYMENT WITHOUT FURTHER SPECIFICATIONS, IT IS ASSUMED THAT THE ADVANCE PAYMENT REFERS TO THE ENTIRE PRICE OF THE PRODUCTS INCLUDED IN THE SUPPLY ORDER.
- 7.3 IF THE PARTIES HAVE AGREED ON PAYMENT BY DIRECT REMITTANCE, THIS SHALL BE DONE BY SWIFT TRANSFER - WITH FIXED VALUE DATE IN FAVOUR OF IMLANI ON THE DAY THE PAYMENT IS DUE - AT THE BANK SPECIFIED BY IMLANI.
- 7.4 IN THE EVENT OF PAYMENT DELAYED UNTIL AFTER THE AGREED DATE, DEFAULT INTEREST AT THE STATUTORY RATE SHALL BE APPLIED TO THE BUYER. IN ADDITION, IMLANI SHALL BE REIMBURSED FOR ANY COSTS INCURRED IN THE RECOVERY OF SUMS NOT PROMPTLY PAID.
- 7.5 THE BUYER IS NOT AUTHORISED TO MAKE ANY DEDUCTION FROM THE AGREED PRICE (E.G. IN CASE OF ALLEGED PRODUCT DEFECTS), WITHOUT PRIOR WRITTEN AGREEMENT WITH IMLANI.

8. FORCE MAJEURE

- 8.1 BOTH THE BUYER AND IMLANI MAY SUSPEND THE PERFORMANCE OF THEIR CONTRACTUAL OBLIGATIONS WHEN SUCH PERFORMANCE BECOMES IMPOSSIBLE OR UNREASONABLY BURDENSOME DUE TO AN UNFORESEEABLE IMPEDIMENT NOT UNDER THEIR CONTROL, SUCH AS FOR EXAMPLE, STRIKES, BOYCOTTS, LOCKOUTS, FIRES, WARS, RIOTS AND REVOLUTIONS, REQUISITIONS, EMBARGOES OR INTERRUPTIONS IN ENERGY SUPPLY.
- 8.2 THE PARTY WISHING TO INVOKE THIS CLAUSE MUST IMMEDIATELY INFORM THE OTHER IN WRITING THAT A FORCE MAJEURE CIRCUMSTANCE HAS OCCURRED AS WELL AS WHEN SUCH CIRCUMSTANCE NO LONGER EXISTS.
- 8.3 IF THE SUSPENSION DUE TO FORCE MAJEURE LASTS MORE THAN EIGHT WEEKS, EACH PARTY SHALL HAVE THE RIGHT TO TERMINATE THE ORDER, SUBJECT TO 10 DAYS' NOTICE, TO BE CONVEYED TO THE OTHER IN WRITING.

9. CHANGE IN THE BUYER'S FINANCIAL SITUATION

- 9.1 IMLANI SHALL BE ENTITLED TO SUSPEND THE FULFILMENT OF THE OBLIGATIONS ARISING FROM THE SUPPLY OF THE PRODUCTS IN THE EVENT THAT THE BUYER'S FINANCIAL SITUATION BECOMES SUCH AS TO SERIOUSLY ENDANGER THE BUYER'S PERFORMANCE OF ITS OWN OBLIGATIONS, UNLESS A SUITABLE GUARANTEE IS GIVEN.

10. APPLICABLE LAW AND JURISDICTION

- 10.1 THE GENERAL TERMS AND CONDITIONS OF SALE AND THE ORDERS ENTERED INTO BETWEEN IMLANI AND THE BUYER SHALL BE GOVERNED BY ITALIAN LAW.
- 10.2 FOR ANY DISPUTE REGARDING THE INTERPRETATION, PERFORMANCE, BREACH OR TERMINATION OF THESE GENERAL TERMS AND CONDITIONS OF SALE, THE COURT OF VICENZA SHALL HAVE EXCLUSIVE JURISDICTION, INCLUDING IN THE EVENT OF JOINDER OF PROCEEDINGS.

11. FINAL CLAUSES

- 11.1 SHOULD ONE OF THE PARTIES FAIL TO TAKE LEGAL ACTION OR EXERCISE A RIGHT UNDER THESE GENERAL TERMS AND CONDITIONS OF SALE, SUCH ACQUIESCENT CONDUCT MAY NOT BE INTERPRETED AS A FINAL WAIVER TO TAKE SUCH LEGAL ACTION OR EXERCISE SUCH RIGHTS IN THE FUTURE.
- 11.2 THE SALE OF PRODUCTS BY IMLANI TO THE BUYER DOES NOT GIVE THE LATTER ANY EXCLUSIVE TERRITORIAL RIGHT NOR DOES IT ALLOW THE BUYER TO TAKE ON THE STATUS OF DISTRIBUTOR OR RESELLER OF IMLANI.
- 11.3 ANY COMMUNICATION FROM THE BUYER TO IMLANI IN RELATION TO THESE GENERAL TERMS AND CONDITIONS OF SALE MUST BE SENT TO THE FOLLOWING CERTIFIED E-MAIL ADDRESS: IMLANISRL@LEGALMAIL.IT. THE AFOREMENTIONED COMMUNICATIONS SHALL TAKE EFFECT UPON RECEIPT BY THE RECIPIENT.

12. PRIVACY

- 12.1 IN ACCORDANCE WITH THE PROVISIONS OF LEGISLATIVE DECREE 196/03, BY ACCEPTING THIS CONTRACT, THE BUYER DECLARES THAT IT IS AWARE, AND EXPRESSLY AGREES, THAT ITS "PERSONAL DATA", PROVIDED (ALSO VERBALLY) BY ITSELF OR ACQUIRED DURING SALE TRANSACTIONS, IS KEPT WITH IMLANI IN ITS (PAPER, ELECTRONIC OR TELECOMMUNICATIONS) ARCHIVES AND PROCESSED AS PART OF THE CONDUCT OF BUSINESS ACTIVITIES OF IMLANI FOR MANAGEMENT PURPOSES, THE FULFILMENT OF LEGAL OBLIGATIONS, AND FOR STATISTICAL, COMMERCIAL, MARKETING, PROMOTIONAL AND CREDIT PROTECTION PURPOSES. SUCH DATA MAY ALSO BE: (A) DISCLOSED TO COMPANIES, ENTITIES, CONSORTIA OR ASSOCIATIONS RESPONSIBLE FOR CREDIT PROTECTION, (B) DISCLOSED/DISSEMINATED TO SUBSIDIARIES, PARENT COMPANIES OR ASSOCIATES ENGAGED IN COMMERCIAL, MARKET RESEARCH, MARKETING, MANAGEMENT OR IT MANAGEMENT ACTIVITIES; OR SUCH COMPANIES CAN BE GIVEN ACCESS TO THE AFOREMENTIONED ARCHIVES. IN RELATION TO THE PROCESSING OF SAID DATA, THE BUYER MAY EXERCISE THE RIGHTS INDICATED IN ART. 7 LEGISLATIVE DECREE 196/03 AND IMLANI HAS AN OBLIGATION TO COMMUNICATE WITHOUT DELAY ANY REQUESTS PURSUANT TO THAT ARTICLE. THE DATA CONTROLLER IS IMLANI IN THE PERSON OF ITS PRO-TEMPORE LEGAL REPRESENTATIVE. THE DATA CAN BE PROCESSED AT THE COMPANY'S REGISTERED OFFICES OR AT TAX CONSULTING FIRMS, AS WELL AS AT THE PREMISES OF ANY OTHER PROFESSIONALS THAT HAVE BEEN TASKED WITH PROCESSING THE ACCOUNTS AND ANY OTHER RELEVANT ASSIGNMENTS.

13. COMPLIANCE WITH LAW 231/2001

- 13.1 THE BUYER ACKNOWLEDGES THAT IMLANI HAS ADOPTED AND IMPLEMENTED AN ORGANISATION, MANAGEMENT AND CONTROL MODEL PURSUANT TO LEGISLATIVE DECREE 231/01, WITH ITS CODE OF ETHICS AND DISCIPLINARY SYSTEM, DETAILS OF WHICH CAN BE VIEWED ON THE COMPANY WEBSITE WWW.IMLANI.IT. THE BUYER ENDORSES THE PRINCIPLES OF THE AFOREMENTIONED ORGANISATION, MANAGEMENT AND CONTROL MODEL AND ITS ANNEXES, AND UNDERTAKES TO COMPLY WITH ITS CONTENTS, PRINCIPLES AND PROCEDURES AND, IN GENERAL, TO REFRAIN FROM ANY CONDUCT THAT MAY CONSTITUTE ANY OF THE OFFENCES SPECIFIED IN ITALIAN LEGISLATIVE DECREE 231/01, AS AMENDED, AND INCLUDED IN THE AFOREMENTIONED ORGANISATION, MANAGEMENT AND CONTROL MODEL. THE BUYER ALSO UNDERTAKES TO COMPLY WITH AND TO ENSURE ITS EMPLOYEES' COMPLIANCE WITH ALL THE PRINCIPLES CONTAINED IN SAID DOCUMENTATION AND BEHAVIOURAL PROTOCOLS PROVIDED BY OUR ORGANISATION IN ACCORDANCE WITH LEGISLATIVE DECREE 231/2001 AND THE ANNEXES TO THIS CONTRACT. ANY BREACH OF THE RULES PROVIDED BY THE AFOREMENTIONED DOCUMENTS SHALL CONSTITUTE A SERIOUS BREACH OF CONTRACT.

iMilani

innovative
italian
ideas

iMilani srl

Via Captano Alessio, 109
36027 Rosà (VI) – Italy

Tel +39 0424 583100
info@imilani.it
www.imilani.it

