



**FITTINGS FOR
COMMERCIAL
VEHICLES**



**STORE
BOXSERIES**



STORE BOX067
page 4



STORE BOX080
page 6



STORE BOX102
page 10



STORE BOX136
page 12



STORE BOX238
page 14



STORE BOX374
page 16



STORE BOXTRAY
page 18



STORE ROLL
page 22



STORE BOXDIVIDER

page 20



STORE CADDY

page 23



STORE BOX067

ITEM NO. F 22 SB BOX067 00 01

Steel case - empty W=438 D=347 H=67 mm



ITEM NO. F 22 SB BOX067 01 01

Steel case with 48 compartments:
48 "red" inset boxes



ITEM NO. F 22 SB BOX067 02 01

Steel case with 24 compartments:
24 "yellow" inset boxes



ITEM NO. F 22 SB BOX067 03 01

Steel case with 12 compartments:
12 "blue" inset boxes



ITEM NO. F 22 SB BOX067 04 01

Steel case with 8 compartments:
8 "green" inset boxes



ITEM NO. F 22 SB BOX067 05 01

Steel case with 4 compartments:
4 "forest" inset boxes



ITEM NO. F 22 SB BOX067 06 01

Steel case with 23 compartments:
12 "red" inset boxes
6 "yellow" inset boxes
3 "blue" inset boxes
2 "green" inset boxes

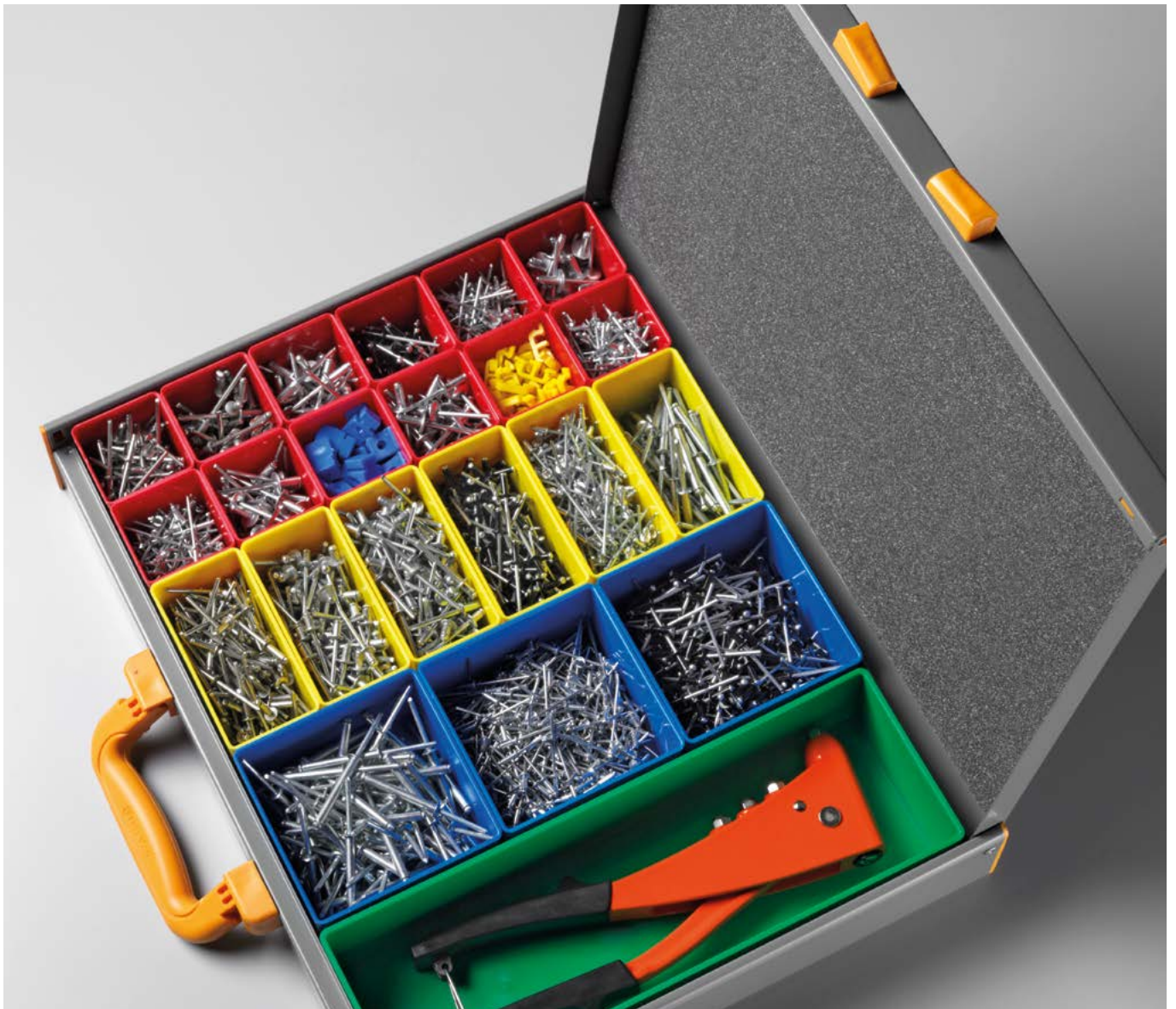

ITEM NO. F 22 SB BOX067 07 01

Steel case with 16 compartments:
 6 "red" inset boxes
 5 "yellow" inset boxes
 2 "blue" inset boxes
 2 "green" inset boxes
 1 "forest" inset box



ITEM NO. F 22 SB BOX067 08 01

Steel case with 10 compartments:
 3 "yellow" inset boxes
 3 "blue" inset boxes
 3 "green" inset boxes
 1 "forest" inset box



ITEM NO. F 22 SB BOX067 09 01

Steel case with 22 compartments:
 12 "red" inset boxes
 6 "yellow" inset boxes
 3 "blue" inset boxes
 1 "forest" inset box



STORE BOX080

ITEM NO. F 22 SB BOX080 00 01

Plastic case - empty W=440 D=350 H=80 mm



ITEM NO. F 22 SB BOX080 01 01

Plastic case with 48 compartments:
48 "red" inset boxes



ITEM NO. F 22 SB BOX080 02 01

Plastic case with 24 compartments:
24 "yellow" inset boxes



ITEM NO. F 22 SB BOX080 03 01

Plastic case with 12 compartments:
12 "blue" inset boxes



ITEM NO. F 22 SB BOX080 04 01

Plastic case with 8 compartments:
8 "green" inset boxes



ITEM NO. F 22 SB BOX080 05 01

Plastic case with 4 compartments:
4 "forest" inset boxes



ITEM NO. F 22 SB BOX080 06 01

Plastic case with 23 compartments:
12 "red" inset boxes
6 "yellow" inset boxes
3 "blue" inset boxes
2 "green" inset boxes

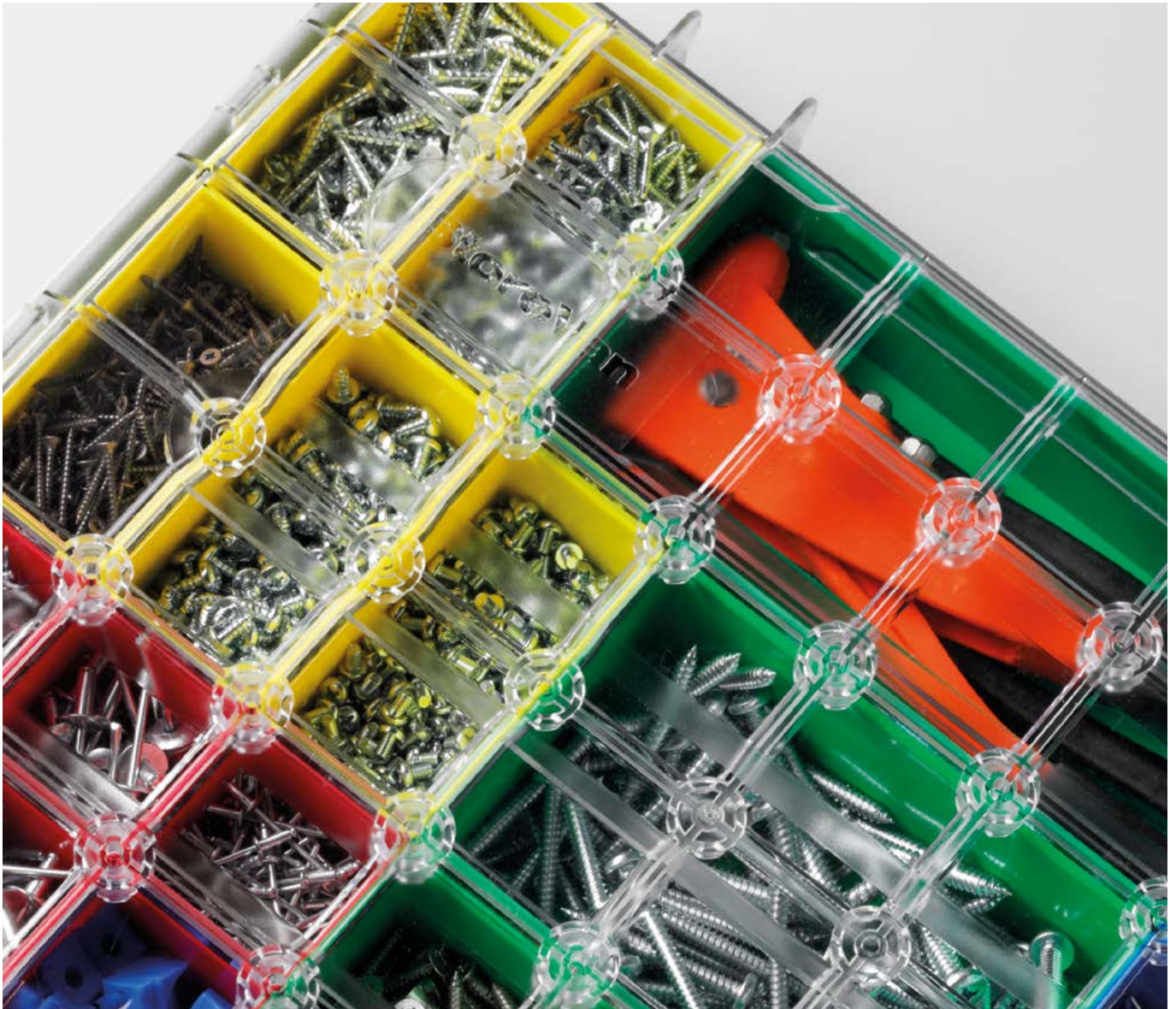

ITEM NO. F 22 SB BOX080 07 01

Plastic case with 16 compartments:
 6 "red" inset boxes
 5 "yellow" inset boxes
 2 "blue" inset boxes
 2 "green" inset boxes
 1 "forest" inset box



ITEM NO. F 22 SB BOX080 08 01

Plastic case with 10 compartments:
 3 "yellow" inset boxes
 3 "blue" inset boxes
 3 "green" inset boxes
 1 "forest" inset box



ITEM NO. F 22 SB BOX080 09 01

Plastic case with 22 compartments:
 12 "red" inset boxes
 6 "yellow" inset boxes
 3 "blue" inset boxes
 1 "forest" inset box



STORE BOX102

ITEM NO. F 22 SB BOX102 00 01

Plastic case - empty W=442 D=357 H=117 mm



ITEM NO. F 22 SB BOX102 01 01

Plastic case with 23 compartments:
1 sky lid insert
2 "grey" inset boxes with dividers
6 "red" inset boxes
6 "yellow" inset boxes
3 "blue" inset boxes



ITEM NO. F 22 SB BOX102 02 01

Plastic case with 19 compartments:
1 sky lid insert
2 "grey" inset boxes with dividers
4 "red" inset boxes
3 "yellow" inset boxes
2 "blue" inset boxes
2 "green" inset boxes



ITEM NO. F 22 SB BOX102 03 01

Plastic case with 18 compartments:
1 sky lid insert
2 "grey" inset boxes with dividers
4 "red" inset boxes
3 "yellow" inset boxes
2 "blue" inset boxes
1 "forest" inset box



ITEM NO. F 22 SB BOX102 04 01

Plastic case with 38 compartments:
1 sky lid insert
2 "grey" inset boxes with dividers
30 "red" inset boxes



ITEM NO. F 22 SB BOX102 05 01

Plastic case with 23 compartments:
1 sky lid insert
2 "grey" inset boxes with dividers
15 "yellow" inset boxes



ITEM NO. F 22 SB BOX102 06 01

Plastic case with 13 compartments:
1 sky lid insert
2 "grey" inset boxes with dividers
5 "green" inset boxes



ITEM NO. F 22 SB BOX102 07 01

Plastic case with 14 compartments:
 1 sky lid insert
 2 "grey" inset boxes with dividers
 2 "red" inset boxes
 2 "yellow" inset boxes
 2 "forest" inset boxes



ITEM NO. F 22 SB BOX102 08 01

Plastic case with 17 compartments:
 1 sky lid insert
 2 "grey" inset boxes with dividers
 3 "yellow" inset boxes
 6 "blue" inset boxes



ITEM NO. F 22 SB BOX102 09 01

Plastic case with 14 compartments:
 1 sky lid insert
 2 "grey" inset boxes with dividers
 3 "blue" inset boxes
 3 "green" inset boxes



ITEM NO. F 22 SB BOX102 10 01

Plastic case with:
 1 sky lid insert
 2 "grey" inset boxes with dividers
 2 store box mini63



ITEM NO. F 22 SB BOX102 11 01

Plastic case with:
 1 sky lid insert
 1 "dark" thermo-formed insert with 5 compartments



ITEM NO. F 22 SB BOX102 12 01

Plastic case with:
 1 sky lid insert
 1 "dark" thermo-formed insert with 12 compartments



STORE BOX102

ITEM NO. F 22 SB BOX102 00 01

Plastic case - empty W=442 D=357 H=117 mm

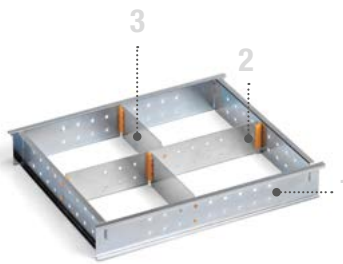

ITEM NO. F 22 SB FRA102 01 99

W=406 D=319 H=61 mm
Divider set with:
1 frame FRA102
1 divider D35102
2 dividers D13102

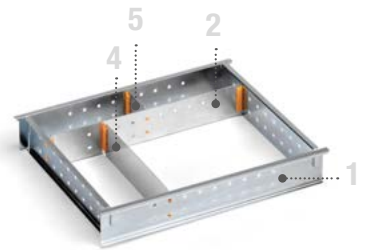

ITEM NO. F 22 SB FRA102 02 99

W=406 D=319 H=61 mm
Divider set with:
1 frame FRA102
1 divider D35102
1 divider D06102
1 divider D21102



ITEM NO. F 22 SB FRA102 00 99

Galvanised steel frame for case
BOX102
W=406 D=319 H=61 mm



2

ITEM NO. F 22 SB D35102 00 00

Horizontal aluminium divider for
frame BOX102
W=352 D=12 H=61 mm



3

ITEM NO. F 22 SB D13102 00 00

Longitudinal aluminium divider
for frame BOX102
W=139 H=60 mm



4

ITEM NO. F 22 SB D21102 00 00

Longitudinal aluminium divider
for frame BOX102
W=218 H=60 mm



5

ITEM NO. F 22 SB D06102 00 00

Longitudinal aluminium divider
for frame BOX102
W=61 H=60 mm

**ITEM NO. F 22 SB MAT001 00 07**

Non-slip rubber mat for
BOX102 - 136 - 238
W=362 D=300 H=1,5 mm

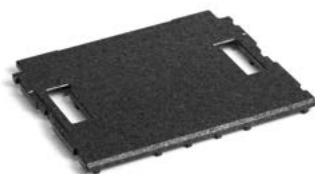
**ITEM NO. F 22 SB SKY001 00 07**

Sky lid insert in expanded polypropylene
W=400 D=320 H=20 mm

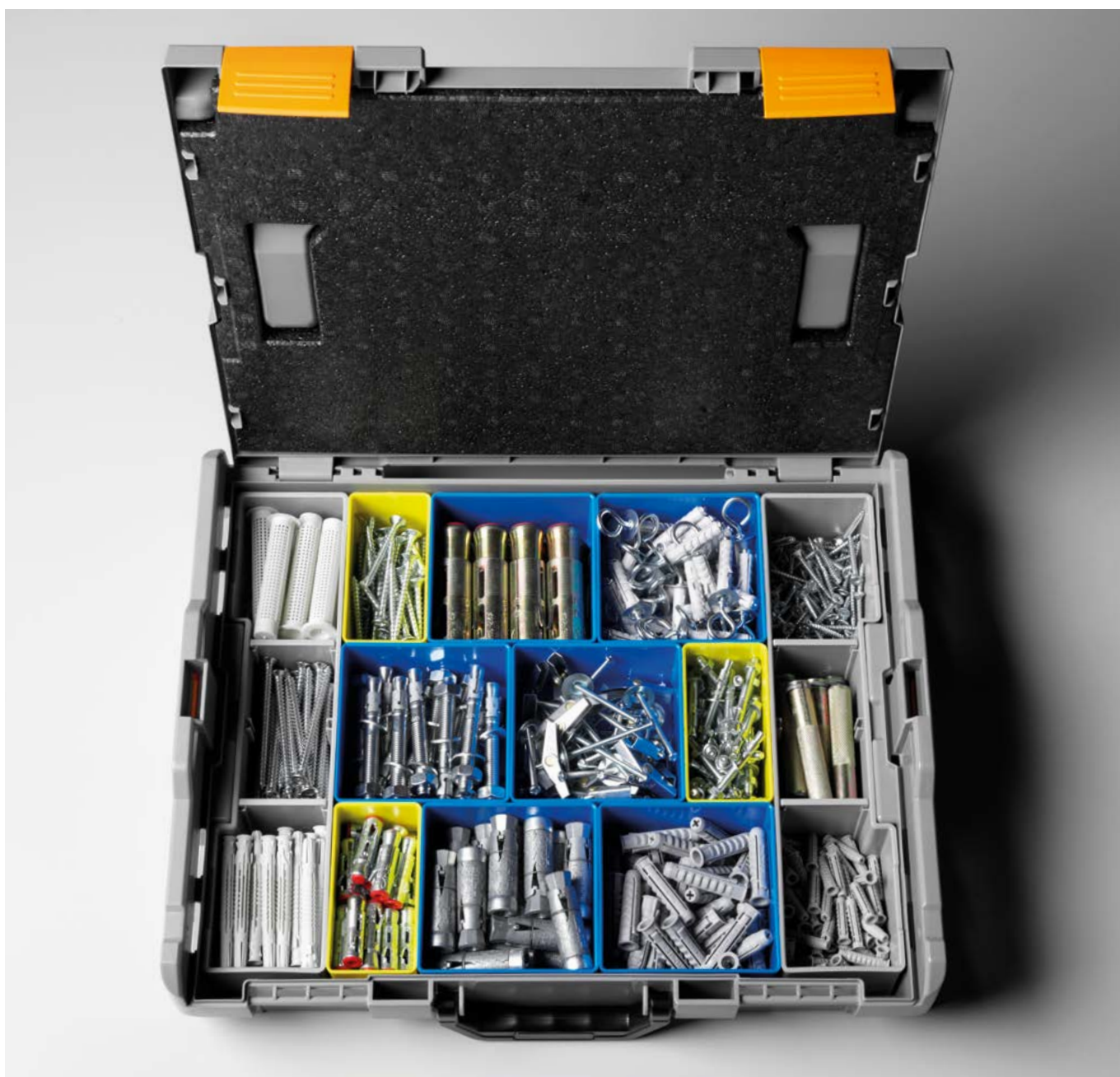



STORE BOX136

ITEM NO. F 22 SB BOX136 00 01

Plastic case - empty W=442 D=357 H=151 mm

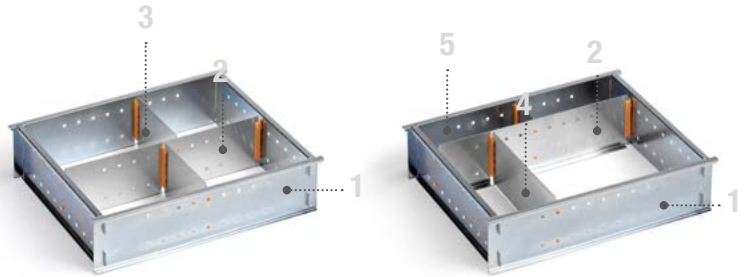

ITEM NO. F 22 SB FRA136 01 99

W=406 D=319 H=96 mm
Divider set with:
1 frame FRA136
1 divider D35136
2 dividers D13136

ITEM NO. F 22 SB FRA136 02 99

W=406 D=319 H=96 mm
Divider set with:
1 frame FRA136
1 divider D35136
1 divider D06136
1 divider D21136



ITEM NO. F 22 SB FRA136 00 99

Galvanised steel frame for case
BOX136
W=406 D=319 H=96 mm



2

ITEM NO. F 22 SB D35136 00 00

Horizontal aluminium divider for
frame BOX136
W=352 D=12 H=96 mm



3

ITEM NO. F 22 SB D13136 00 00

Longitudinal aluminium divider
for frame BOX136
W=139 H=95 mm



4

ITEM NO. F 22 SB D21136 00 00

Longitudinal aluminium divider
for frame BOX136
W=218 H=95 mm



5

ITEM NO. F 22 SB D06136 00 00

Longitudinal aluminium divider
for frame BOX136
W=61 H=95 mm



ITEM NO. F 22 SB MAT001 00 07

Non-slip rubber mat for
BOX102 - 136 - 238
W=362 D=300 H=1,5 mm

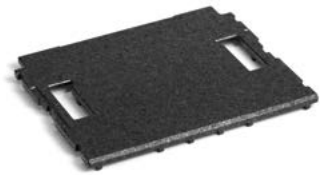

ITEM NO. F 22 SB SKY001 00 07

Sky lid insert in expanded polypropylene
W=400 D=320 H=20 mm



Sky lid insert

Tray with divider
set, see page 18



1

ITEM NO. F 22 SB SUP136 00 99

Galvanised steel support for case BOX136
W=401 D=311 H=32 mm





STORE BOX238

ITEM NO. F 22 SB BOX238 00 01

Plastic case - empty W=442 D=357 H=253 mm

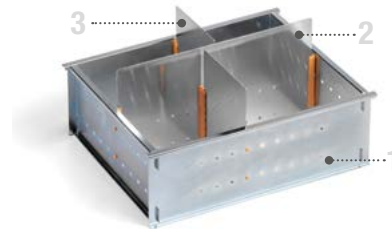

ITEM NO. F 22 SB FRA238 03 99

W=402 D=312 H=194 mm

Divider set with:

1 frame FRA238

1 divider D36238

2 dividers D14238



1

ITEM NO. F 22 SB FRA238 00 99

Galvanised steel frame for case
BOX238 - BOX374
W=402 D=312 H=132 mm



2

ITEM NO. F 22 SB D36238 00 00

Horizontal aluminium divider for
frame BOX238
W=352 D=12 H=194 mm



3

ITEM NO. F 22 SB D14238 00 00

Longitudinal aluminium divider
for frame BOX238
W=135 H=193 mm



ITEM NO. F 22 SB MAT001 00 07

Non-slip rubber mat for
BOX102 - 136 - 238
W=362 D=300 H=1,5 mm



ITEM NO. F 22 SB SKY001 00 07

Sky lid insert in expanded polypropylene
W=400 D=320 H=20 mm



Sky lid insert

Tray with divider set, see page 18

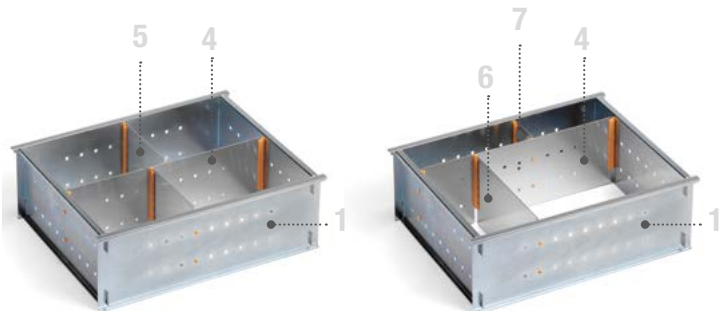

ITEM NO. F 22 SB FRA238 01 99

W=402 D=312 H=132 mm
Divider set with:
1 frame FRA238
1 divider D35238
2 dividers D13238

ITEM NO. F 22 SB FRA238 02 99

W=402 D=312 H=132 mm
Divider set with:
1 frame FRA238
1 divider D05238
1 divider D21238



ITEM NO. F 22 SB FRA238 00 99

Galvanised steel frame for case
BOX238 - BOX374
W=402 D=312 H=132 mm



4

ITEM NO. F 22 SB D35238 00 00

Horizontal aluminium divider for
frame BOX238
W=352 D=12 H=132 mm



5

ITEM NO. F 22 SB D13238 00 00

Longitudinal aluminium divider
for frame BOX238
W=135 H=131 mm



6

ITEM NO. F 22 SB D21238 00 00

Longitudinal aluminium divider
for frame BOX238
W=213 H=131 mm



7

ITEM NO. F 22 SB D05238 00 00

Longitudinal aluminium divider
for frame BOX238
W=57 H=131 mm



STORE BOX374

ITEM NO. F 22 SB BOX374 00 01

Plastic case - empty W=442 D=357 H=389 mm

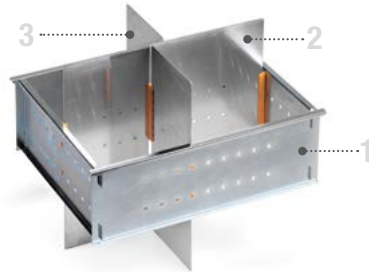

ITEM NO. F 22 SB FRA374 01 99

W=402 D=312 H=330 mm

Divider set with:

1 frame FRA238

1 divider D36374

2 dividers D14374



ITEM NO. F 22 SB FRA238 00 99

Galvanised steel frame for case
BOX238 - BOX374
W=402 D=312 H=132 mm



2

ITEM NO. F 22 SB D36374 00 00

Horizontal aluminium divider for
frame BOX374
W=352 D=12 H=330 mm



3

ITEM NO. F 22 SB D14374 00 00

Longitudinal aluminium divider
for frame BOX374
W=135 H=329 mm



ITEM NO. F 22 SB MAT002 00 07

Non-slip rubber mat for
BOX374
W=362 D=290 H=1,5 mm



ITEM NO. F 22 SB SKY001 00 07

Sky lid insert in expanded polypropylene
W=400 D=320 H=20 mm

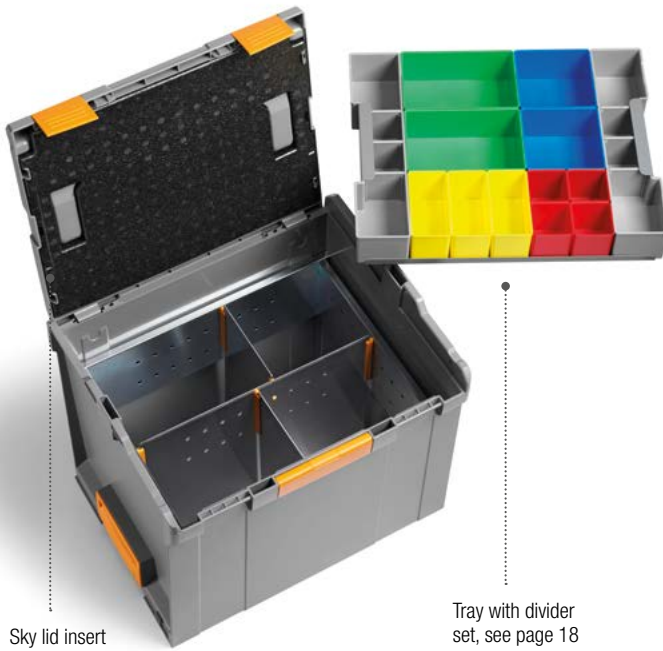

Sky lid insert

Tray with divider set, see page 18

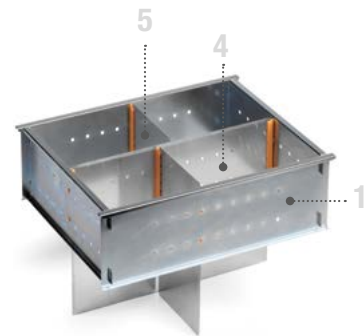

ITEM NO. F 22 SB FRA374 02 99

W=402 D=312 H=260 mm
Divider set with:
1 frame FRA238
1 divider D35374
2 dividers D13374



ITEM NO. F 22 SB FRA238 00 99

Galvanised steel frame for case
BOX238 - BOX374
W=402 D=312 H=132 mm



4

ITEM NO. F 22 SB D35374 00 00

Horizontal aluminium divider for
frame BOX374
W=352 D=12 H=260 mm



5

ITEM NO. F 22 SB D13374 00 00

Longitudinal aluminium divider
for frame BOX374
W=135 H=259 mm

STORE BOXTRAY



ITEM NO. F 22 SB 00TRAY 00 01

Steel tray, empty for Store Box 136 - 238 - 374
W=380 D=313 H=65 mm



ITEM NO. F 22 SB 00TRAY 01 01

Steel tray with 23 compartments:
2 "grey" inset boxes with dividers
6 "red" inset boxes
6 "yellow" inset boxes
3 "blue" inset boxes



ITEM NO. F 22 SB 00TRAY 02 01

Steel tray with 19 compartments:
2 "grey" inset boxes with dividers
4 "red" inset boxes
3 "yellow" inset boxes
2 "blue" inset boxes
2 "green" inset boxes



ITEM NO. F 22 SB 00TRAY 03 01

Steel tray with 18 compartments:
2 "grey" inset boxes with dividers
4 "red" inset boxes
3 "yellow" inset boxes
2 "blue" inset boxes
1 "forest" inset box



ITEM NO. F 22 SB 00TRAY 04 01

Steel tray with 38 compartments:
2 "grey" inset boxes with dividers
30 "red" inset boxes



ITEM NO. F 22 SB 00TRAY 05 01

Steel tray with 23 compartments:
2 "grey" inset boxes with dividers
15 "yellow" inset boxes



ITEM NO. F 22 SB 00TRAY 06 01

Steel tray with 13 compartments:
2 "grey" inset boxes with dividers
5 "green" inset boxes



ITEM NO. F 22 SB 00TRAY 07 01

Steel tray with 14 compartments:
 2 "grey" inset boxes with dividers
 2 "red" inset boxes
 2 "yellow" inset boxes
 2 "forest" inset boxes



ITEM NO. F 22 SB 00TRAY 08 01

Steel tray with 17 compartments:
 2 "grey" inset boxes with dividers
 3 "yellow" inset boxes
 6 "blue" inset boxes



ITEM NO. F 22 SB 00TRAY 09 01

Steel tray with 14 compartments:
 2 "grey" inset boxes with dividers
 3 "blue" inset boxes
 3 "green" inset boxes



ITEM NO. F 22 SB 00TRAY 10 01

Steel tray with:
 2 "grey" inset boxes with dividers
 2 store box miniG3



ITEM NO. F 22 SB 00TRAY 11 01

Steel tray with:
 1 "dark" thermo-formed insert with 5 compartments



ITEM NO. F 22 SB 00TRAY 12 01

Steel tray with:
 1 "dark" thermo-formed insert with 12 compartments

STORE BOXDIVIDER



ITEM NO. F 22 SB 000RED 63 03

"Red" inset box W=52 D=52 H=63

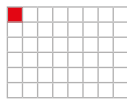

BOX067
BOX080

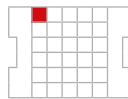

BOX102
BOXTRAY

ITEM NO. F 22 SB YELLOW 63 05

"Yellow" inset box W=52 D=104 H=63

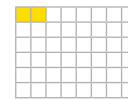

BOX067
BOX080

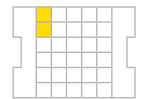

BOX102
BOXTRAY

ITEM NO. F 22 SB 00BLUE 63 16

"Blue" inset box W=104 D=104 H=63

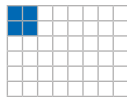

BOX067
BOX080

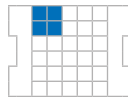

BOX102
BOXTRAY

ITEM NO. F 22 SB 0GREEN 63 14

"Green" inset box W=104 D=156 H=63

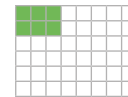

BOX067
BOX080



BOX102
BOXTRAY

ITEM NO. F 22 SB FOREST 63 09

"Forest" inset box W=104 D=312 H=63

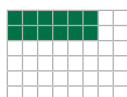

BOX067
BOX080

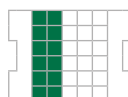

BOX102
BOXTRAY

ITEM NO. F 22 SB MINI63 63 08

Store Box Mini63 W=260 D=155 H=63

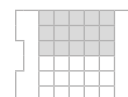

BOX102
BOXTRAY



ITEM NO. F 22 SB 00GREY 63 01

"Grey" inset box W=71 D=312 H=63

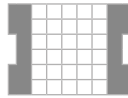

BOX102
BOXTRAY

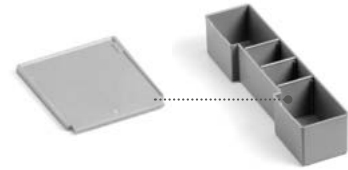

ITEM NO. F 22 SB DVGREY 58 01

Divider for "grey" inset box W=52 D=4 H=58



ITEM NO. F 22 SB DARK05 62 07

"Dark" thermo-formed insert with 5 compartments - W=405 D=315 H=62



BOX102
BOXTRAY



ITEM NO. F 22 SB DARK12 62 07

"Dark" thermo-formed insert with 12 compartments - W=405 D=315 H=62



BOX102
BOXTRAY



STORE ROLL

ITEM NO. F 22 SB 00ROLL 00 08

Trolley for cases BOX102 - 136 - 238 - 374
with two castor wheels with brake and two standard castors
Load capacity 100 kg
W=650 D=510 H=150 mm





STORE CADDY

ITEM NO. F 22 SB OCADDY 00 00

Fold-away trolley in aluminium
Load capacity 80 kg
Open dimensions W=490 D=490 H=1090 mm
Closed dimensions W=490 D=60 H=760 mm



WWW.STOREVAN.COM



FAMI S.r.l.

Via Stazione Rossano, 13 | 36027 Rosà (VI) | ITALY
phone +39 0424 585455 | fax +39 0424 585482
www.famispaspa.com | info@famispaspa.com
www.storevan.com | info@storevan.com

