

**EXTENSIBLE SHELF  
RACKING SYSTEM  
FOR HEAVY GOODS,  
IDEAL DESIGN FOR  
PICKING STORED  
GOODS WITH AN  
OVERHEAD CRANE**





Courtesy of Vimar S.p.A.

# SYSTEM AR

# TECHNICAL SPECIFICATIONS

The F AR shelving system, thanks to its extensible shelves, is especially suitable for storing very heavy material (moulds, engines etc.), which can be handled in complete safety by using an overhead crane and a lift truck. The shelves can have plain or telescopic extension, and a capacity ranging between 800 and 1000 kg.

Courtesy of Meccanostampi S.r.l



## SHELVING SIDES

Made of sectional steel, they have slots to a 50 mm pitch on both sides.

The two uprights are connected to each other by two horizontal cross bars and a cross piece, forming a sturdy side wall. The sides are equipped with steel plates for floor fixing.



## SLIDING DOORS

They are made of sheet steel specially shaped to improve solidity.

Doors are used to protect the shelved goods from impacts and dust. Each pair of sliding doors covers two shelving span lengths and has a cylinder lock with two keys.



## SIDE AND REAR WALL PANELS

The side and rear walls are fixed with screws to the structure and, when used together, can form enclosed compartments. In addition, the rear walls do not require the fitting of any cross pieces.

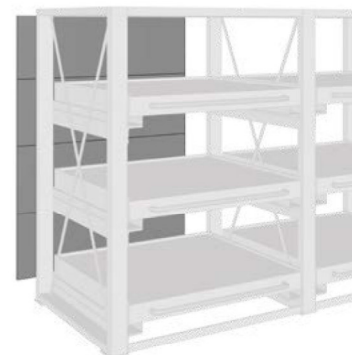
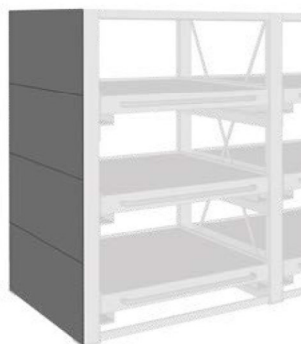

# SYSTEM F AR



## SINGLE OPENING DEVICE FOR EXTENSIBLE SHELVES

For safety purposes, each extensible shelf must be opened individually. The device consists of a rod to be installed on the side wall (one for each span) with a hook to be applied to each extensible shelf. Opening only one shelf at a time avoids dangerous shifting of unsecured heavy loads, which might overturn the structure.



### EXTENSIBLE SHELF LOCKING HOOK

A hook located on the front of the side walls allows the shelf to be locked in the opening and closing phases. In the opening phase, locking the shelf allows any material to be taken in complete safety.



plain shelf locking hook



telescopic shelf locking hook

## SAFETY

## FLOOR SUPPORT PLATE

The support plate is designed to distribute the pressure applied on the floor by the side wall. A technical data sheet supplied by FAMI is useful to check the suitability of the floor intended for racking system installation.

The support plate is provided with a hole for plate anchoring to the floor by means of standard anchor bolts. This operation is necessary to ensure shelf safety.

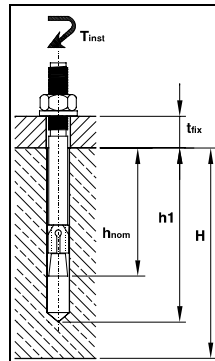

\*The floor on which the racking system rests must be checked in terms of suitability for withstanding the pressure and the puncturing (drilling) stress applied by the shelving system itself and the pulling strength exerted by the anchor.

\*\*The area must not be submitted to any other force.



recommended anchor strength	11,65 Kn
anchor diameter	Ø16 mm
concrete hole diameter	Ø16 mm
minimum hole depth	$h_1$ 115 mm
minimum installation depth	$h_{nom}$ 95 mm
max adjustable thickness	$t_{fx}$ 25 mm
max tightening torque	$T_{inst}$ 125 Nm
min floor thickness for anchor plug fixing*	H: 160 mm
min anchor distance from the edge of the floor	B: 175 mm
anchor strength application area**	A: 112,5 mm
min upright distance from the edge of the floor	C: 75 mm

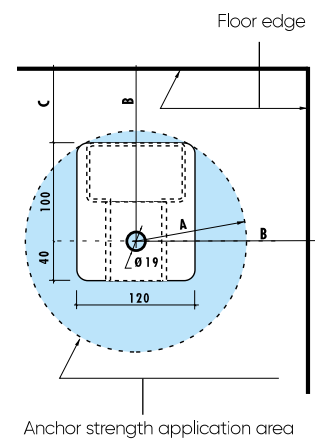

Anchor strength application area

## COMBINATION OF SERIES COLOURS



grey RAL 7000



green RAL 6011



blue RAL 5012



5000	Capacity each span
1000	Telescopic extension shelf capacity
800	Plain extension shelf capacity
300	Strengthening shelf capacity for depth 900 mm
250	Strengthening shelf capacity for depth 1100 mm
200	Strengthening shelf capacity for depth 1300 mm

# SYSTEM F AR

## PLAIN EXTENSION SHELVES

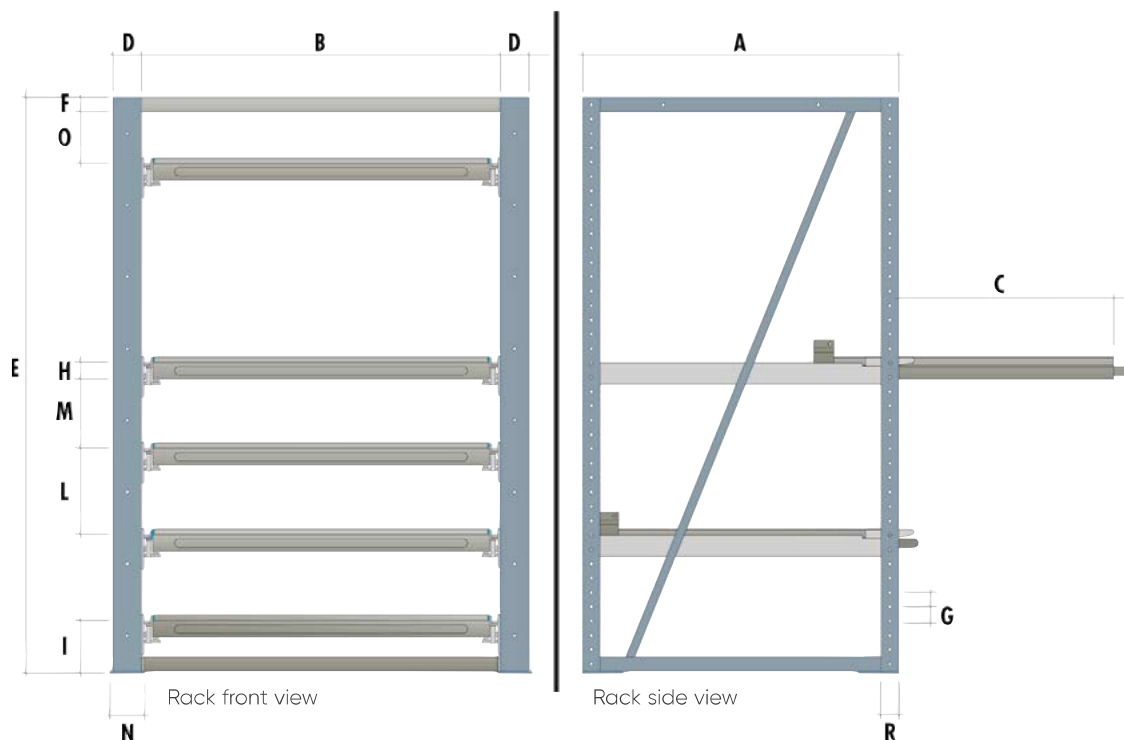

		mm
A	RACK DEPTH	900, 1100, 1300
B	WORKING SPAN LENGTH	1250
C	EXTENSIBILITY	600, 750, 900
D	SIDE WIDTH	100
E	RACK HEIGHT	1510, 2010, 2210, 2510, 3010
F	TOP SHELF	50
G	ADJUSTABLE PITCH	50
H	EXTENSIBLE SHELVES	58
I	MINIMUM HEIGHT FROM FLOOR	185
L	MINIMUM DISTANCE BETWEEN SHELVES	300
M	MINIMUM SPAN BETWEEN SHELVES	225
N	PLATE FOR SIDE PANEL	120
O	MINIMUM DISTANCE FROM UPPER SHELF	175
R	FOOTPRINT	60
	UPRIGHT SHEET METAL THICKNESS	3

Courtesy of Vimar S.p.A.



## TELESCOPIC EXTENSION SHELVES

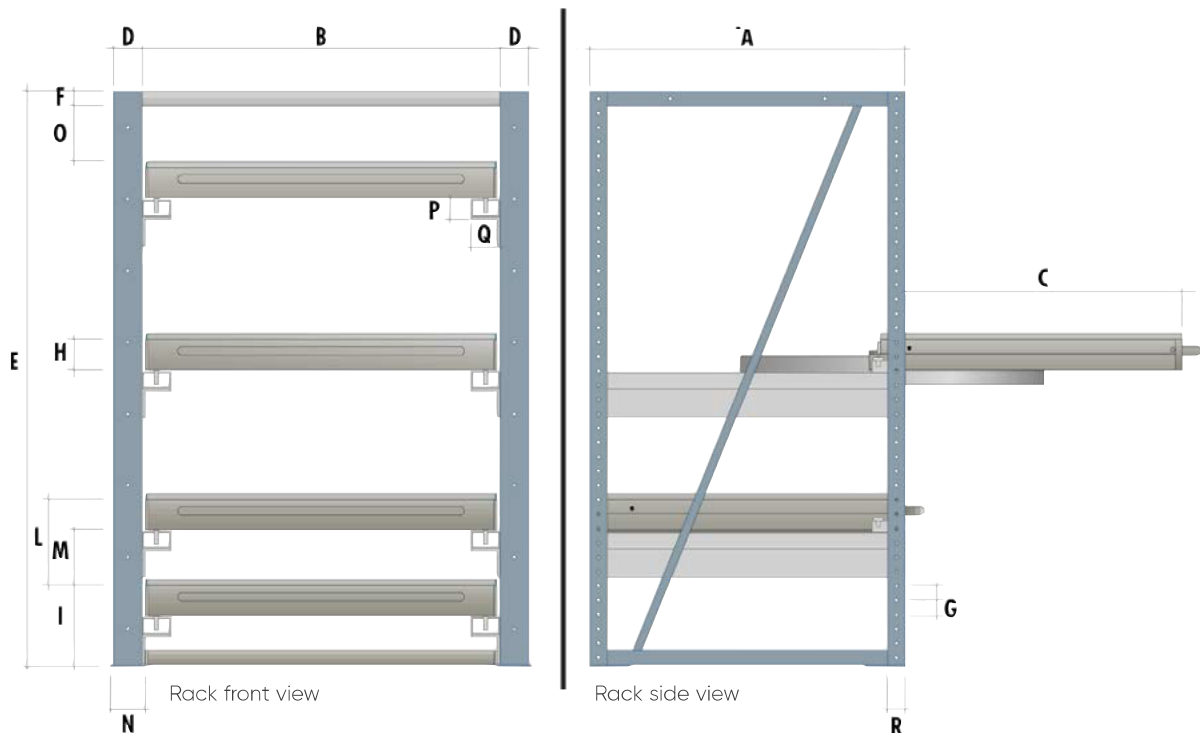

		mm
A	RACK DEPTH	900, 1100, 1300
B	WORKING SPAN LENGTH	850, 1050, 1250
C	EXTENSIBILITY	770, 970, 1170
D	SIDE WIDTH	100
E	RACK HEIGHT	1510, 2010, 2210, 2510, 3010
F	TOP SHELF	50
G	ADJUSTABLE PITCH	50
H	EXTENSIBLE SHELVES	107
I	MINIMUM HEIGHT FROM FLOOR	285
L	MINIMUM DISTANCE BETWEEN SHELVES	300
M	MINIMUM SPAN BETWEEN SHELVES	190
N	PLATE FOR SIDE PANEL	120
O	MINIMUM DISTANCE FROM UPPER SHELF	50
P	SLIDE HEIGHT	80
Q	SLIDE WIDTH	100
R	FOOTPRINT	60
	UPRIGHT SHEET METAL THICKNESS	3

Courtesy of Vimar S.p.A.





# SYSTEM F AR





# SYSTEM F AR

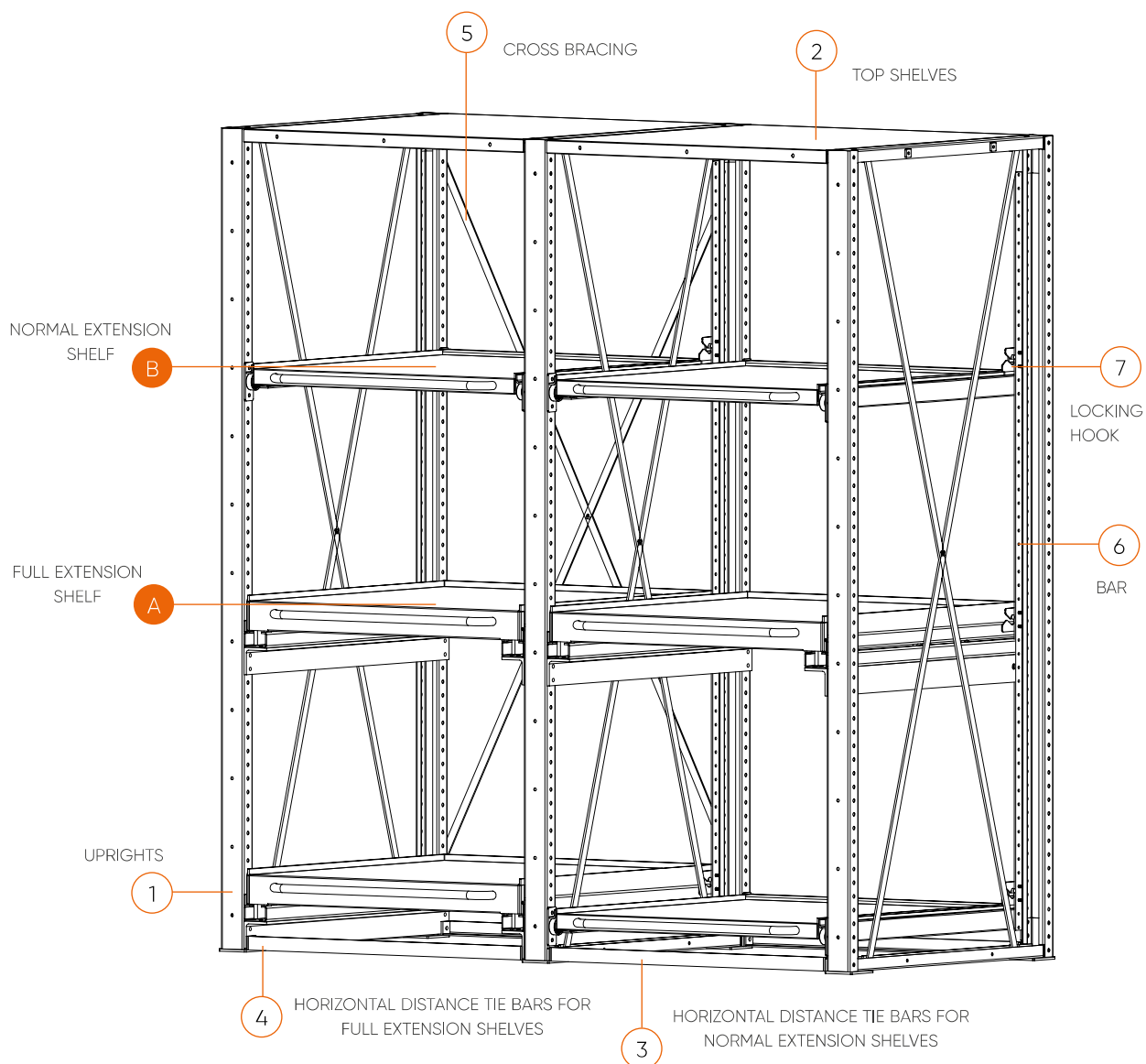

METAL COLOURS

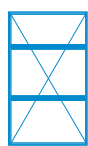

RAL 5012  
.04



RAL 7000  
.01



RAL 6011  
.02



ALL INDICATED LOAD CAPACITY VALUES ARE NET AND REFER TO EVENLY DISTRIBUTED WEIGHTS

## UPRIGHTS

1	ART.	H uprights mm	depth mm	
	F AR 2050 00	1510		
	F AR 2060 00	2010		
	F AR 2070 00	2210	900	
	F AR 2080 00	2510		
	F AR 2090 00	3010		
	F AR 2100 00	1510		
	F AR 2110 00	2010		
	F AR 2120 00	2210	1100	
	F AR 2130 00	2510		
	F AR 2140 00	3010		
	F AR 2150 00	1510		
	F AR 2160 00	2010		
	F AR 2170 00	2210	1300	
	F AR 2180 00	2510		
	F AR 2190 00	3010		

Sides are supplied disassembled  
 Fixing material consisting of 2 expansion plugs in M16x140 steel supplied as standard.

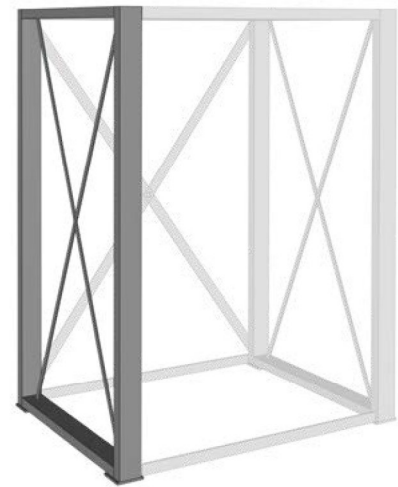

## TOP SHELVES

2	ART.	kg	dim. mm	
	F AR 4020 00	300	850x900x50 H	
	F AR 4030 00	250	850x1100x50 H	
	F AR 4040 00	200	850x1300x50 H	
	F AR 4120 00	300	1050x900x50 H	
	F AR 4130 00	250	1050x1100x50 H	
	F AR 4140 00	200	1050x1300x50 H	
	F AR 4220 00	300	1250x900x50 H	
	F AR 4230 00	250	1250x1100x50 H	
	F AR 4240 00	200	1250x1300x50 H	

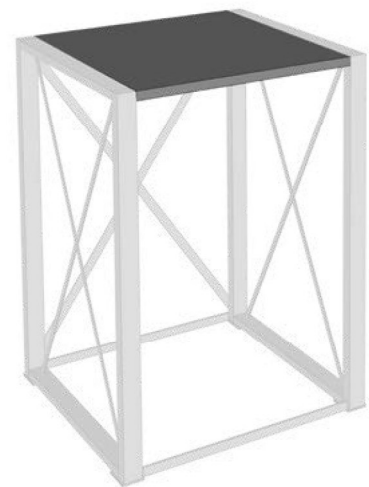

## HORIZONTAL DISTANCE TIE BARS FOR NORMAL EXTENSION SHELVES

3	ART.	working span mm	
	F AR 1040 00	1250	

2 bars are required for each span



## HORIZONTAL DISTANCE TIE BARS FOR FULL EXTENSION SHELVES

4	ART.	working span mm	
	F AR 1010 00	850	
	F AR 1020 00	1050	
	F AR 1030 00	1250	

2 bars are required for each span



# SYSTEM F AR

## CROSS BRACING

5	ART.	H uprights mm	working span mm
	F AR 1850 00 _ _	1510	
	F AR 1860 00 _ _	2010	
	F AR 1870 00 _ _	2210	850
	F AR 1880 00 _ _	2510	
	F AR 1890 00 _ _	3010	
	F AR 1900 00 _ _	1510	
	F AR 1910 00 _ _	2010	
	F AR 1920 00 _ _	2210	1050
	F AR 1930 00 _ _	2510	
	F AR 1940 00 _ _	3010	
	F AR 1950 00 _ _	1510	
	F AR 1960 00 _ _	2010	
	F AR 1970 00 _ _	2210	1250
	F AR 1980 00 _ _	2510	
	F AR 1990 00 _ _	3010	



It is required to use one span with cross bracing every at least 2 span lengths



## BAR

6	ART.	H uprights mm
	F AR 1100 00 _ _	1510
	F AR 1110 00 _ _	2010
	F AR 1120 00 _ _	2210
	F AR 1130 00 _ _	2510
	F AR 1140 00 _ _	3010

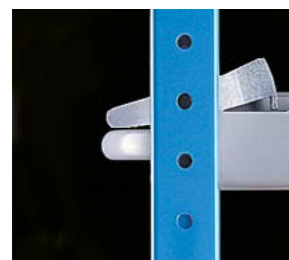

## LOCKING HOOK

7	ART.
	The hook is supplied as standard equipment with the extensible shelf



### Single opening

The "AR" series shelving unit must be fitted with the single opening device for extensible shelves. This device allows one shelf at a time to be pulled out and consists of a rod of the same height as the side wall and locking hooks, which must be screwed into the rod to match the extensible shelves. One rod for each span and one hook for each extensible shelf are required (the hook is supplied as standard with the extensible shelf.)

METAL COLOURS

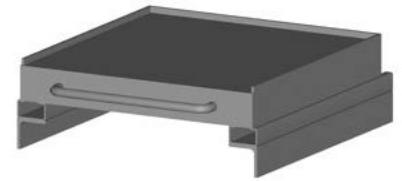
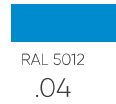

**A** FULL EXTENSION SHELVES WITH 3 EDGES

**SPAN WIDTH 850 mm**

ART.		Working span mm	Shelf depth mm	Usable width mm	Usable depth mm	Extension mm
<b>F AR 7400 00</b> __		850	900	805	845	770
<b>F AR 7410 00</b> __		850	1100	805	1045	970
<b>F AR 7420 00</b> __		850	1300	805	1245	1170

**SPAN WIDTH 1050 mm**

ART.		Working span mm	Shelf depth mm	Usable width mm	Usable depth mm	Extension mm
<b>F AR 7500 00</b> __		1050	900	1005	845	770
<b>F AR 7510 00</b> __		1050	1100	1005	1045	970
<b>F AR 7520 00</b> __		1050	1300	1005	1245	1170

**SPAN WIDTH 1250 mm**

ART.		Working span mm	Shelf depth mm	Usable width mm	Usable depth mm	Extension mm
<b>F AR 7600 00</b> __		1250	900	1205	845	770
<b>F AR 7610 00</b> __		1250	1100	1205	1045	970
<b>F AR 7620 00</b> __		1250	1300	1205	1245	1170



**CAPACITY 1000 kg**

All load capacity values are net and refer to evenly distributed weights



The extension shelves are supplied with a capacity sticker.



**SPAN WIDTH**

# SYSTEM F AR

METAL  
COLOURS 

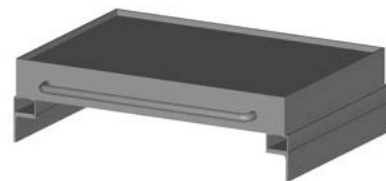
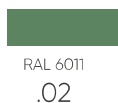
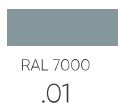

## A FULL EXTENSION SHELVES WITH 4 EDGES

### SPAN WIDTH 850 mm

ART.		Working span mm	Shelf depth mm	Usable width mm	Usable depth mm	Extension mm
F AR 7450 00 _ _		850	900	805	845	770
F AR 7460 00 _ _		850	1100	805	1045	970
F AR 7470 00 _ _		850	1300	805	1245	1170

### SPAN WIDTH 1050 mm

ART.		Working span mm	Shelf depth mm	Usable width mm	Usable depth mm	Extension mm
F AR 7550 00 _ _		1050	900	1005	845	770
F AR 7560 00 _ _		1050	1100	1005	1045	970
F AR 7570 00 _ _		1050	1300	1005	1245	1170

### SPAN WIDTH 1250 mm

ART.		Working span mm	Shelf depth mm	Usable width mm	Usable depth mm	Extension mm
F AR 7650 00 _ _		1250	900	1205	845	770
F AR 7660 00 _ _		1250	1100	1205	1045	970
F AR 7670 00 _ _		1250	1300	1205	1245	1170

## SPAN WIDTH

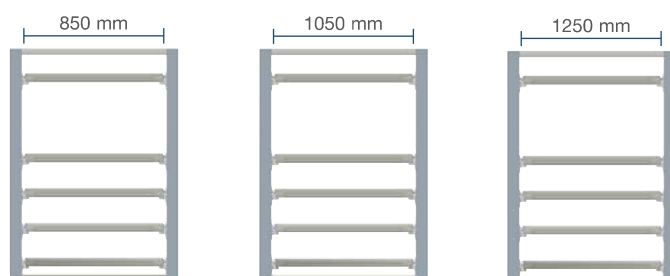

**CAPACITY 1000 kg**

All load capacity values are net and refer to evenly distributed weights



The extension shelves are supplied with a capacity sticker.

METAL COLOURS

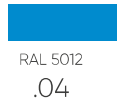

**A** FULL EXTENSION SHELVES WITH 4 EDGES AND MULTIPLEX COVERING

**SPAN WIDTH 850 mm**

ART.	Working span mm	Shelf depth mm	Usable width mm	Usable depth mm	Extension mm
<b>F AR 7450 01</b> __	850	900	805	845	770
<b>F AR 7460 01</b> __	850	1100	805	1045	970
<b>F AR 7470 01</b> __	850	1300	805	1245	1170

**SPAN WIDTH 1050 mm**

ART.	Working span mm	Shelf depth mm	Usable width mm	Usable depth mm	Extension mm
<b>F AR 7550 01</b> __	1050	900	1005	845	770
<b>F AR 7560 01</b> __	1050	1100	1005	1045	970
<b>F AR 7570 01</b> __	1050	1300	1005	1245	1170

**SPAN WIDTH 1250 mm**

ART.	Working span mm	Shelf depth mm	Usable width mm	Usable depth mm	Extension mm
<b>F AR 7650 01</b> __	1250	900	1205	845	770
<b>F AR 7660 01</b> __	1250	1100	1205	1045	970
<b>F AR 7670 01</b> __	1250	1300	1205	1245	1170



**CAPACITY 1000 kg**

All load capacity values are net and refer to evenly distributed weights



The extension shelves are supplied with a capacity sticker.

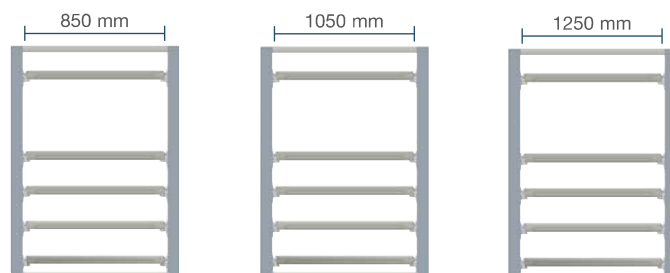

**SPAN WIDTH**



# SYSTEM F AR

METAL  
COLOURS

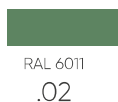
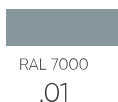

## B NORMAL EXTENSION SHELVES WITH 3 EDGES



SPAN WIDTH 1250 mm

ART.		Working span mm	Shelf depth mm	Usable width mm	Usable depth mm	Extension mm
<b>F AR 6600 00</b> __		1250	900	1160	800	600
<b>F AR 6610 00</b> __		1250	1100	1160	1000	750
<b>F AR 6620 00</b> __		1250	1300	1160	1200	900

## B NORMAL EXTENSION SHELVES WITH 4 EDGES



SPAN WIDTH 1250 mm

ART.		Working span mm	Shelf depth mm	Usable width mm	Usable depth mm	Extension mm
<b>F AR 6650 00</b> __		1250	900	1160	800	600
<b>F AR 6660 00</b> __		1250	1100	1160	1000	750
<b>F AR 6670 00</b> __		1250	1300	1160	1200	900



## B NORMAL EXTENSION SHELVES WITH 4 EDGES AND MULTIPLEX COVERING

SPAN WIDTH 1250 mm

ART.		Working span mm	Shelf depth mm	Usable width mm	Usable depth mm	Extension mm
<b>F AR 6650 01</b> __		1250	900	1160	800	600
<b>F AR 6660 01</b> __		1250	1100	1160	1000	750
<b>F AR 6670 01</b> __		1250	1300	1160	1200	900

SPAN  
WIDTH



**CAPACITY 800 kg**

All load capacity values are net and refer to evenly distributed weights



The extension shelves are supplied with a capacity sticker.



Courtesy of Vimar S.p.A.

H 2

H 3

H 4

# SYSTEM F AR

METAL  
COLOURS 

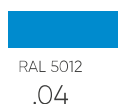
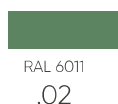

## REAR WALLS

ART.		H shelf mm	Rear wall with plates no.	Span width mm
F AR 1450 00	__	1510	3	850
F AR 1460 00	__	2010	4	
F AR 1470 00	__	2210	4	
F AR 1480 00	__	2510	5	
F AR 1490 00	__	3010	6	
F AR 1500 00	__	1510	3	
F AR 1510 00	__	2010	4	1050
F AR 1520 00	__	2210	4	
F AR 1530 00	__	2510	5	
F AR 1540 00	__	3010	6	
F AR 1550 00	__	1510	3	
F AR 1560 00	__	2010	4	
F AR 1570 00	__	2210	4	
F AR 1580 00	__	2510	5	
F AR 1590 00	__	3010	6	

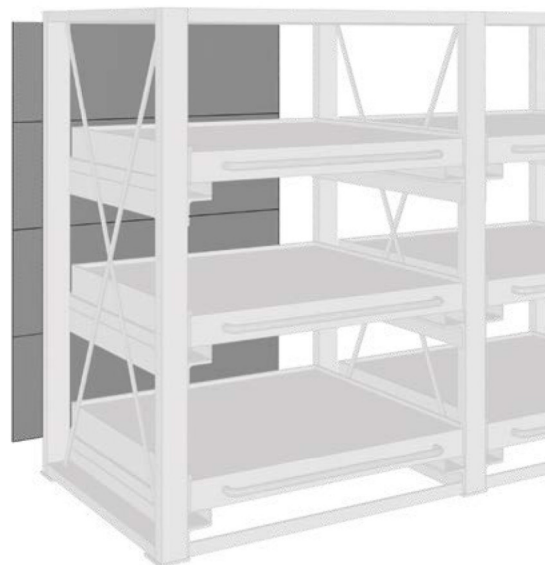

A back panel must be fitted to each 2 bays

## SIDE WALLS

ART.		H shelf mm	Back panel with plates no.	Span width mm
F AR 1250 00	__	1510	3	900
F AR 1260 00	__	2010	4	
F AR 1270 00	__	2210	4	
F AR 1280 00	__	2510	5	
F AR 1290 00	__	3010	6	
F AR 1300 00	__	1510	3	
F AR 1310 00	__	2010	4	1100
F AR 1320 00	__	2210	4	
F AR 1330 00	__	2510	5	
F AR 1340 00	__	3010	6	
F AR 1350 00	__	1510	3	
F AR 1360 00	__	2010	4	
F AR 1370 00	__	2210	4	
F AR 1380 00	__	2510	5	
F AR 1390 00	__	3010	6	

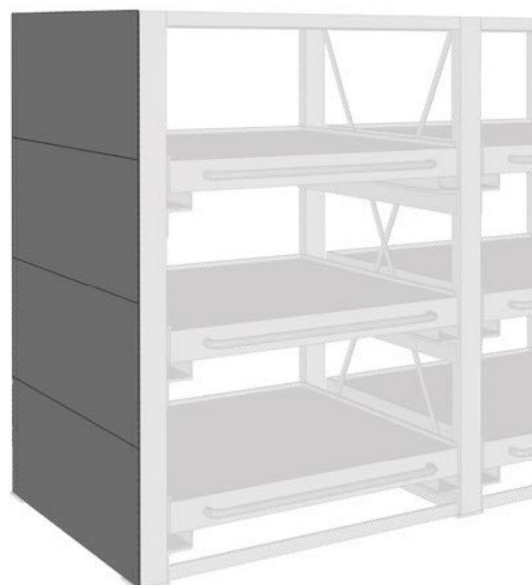

## PAIR OF SLIDING DOORS

ART.		H shelf mm	Shelf thickness mm	Span width mm	Shelving width mm
F AR 5000 00	__	1510	165		
F AR 5050 00	__	2010	165		
F AR 5100 00	__	2210	165	850	1900
F AR 5150 00	__	2510	165		
F AR 5200 00	__	3010	165		
F AR 5250 00	__	1510	165		
F AR 5300 00	__	2010	165		
F AR 5350 00	__	2210	165	1050	2300
F AR 5400 00	__	2510	165		
F AR 5450 00	__	3010	165		
F AR 5500 00	__	1510	165		
F AR 5550 00	__	2010	165		
F AR 5600 00	__	2210	165	1250	2700
F AR 5650 00	__	2510	165		
F AR 5700 00	__	3010	165		



The sliding doors close 2 span bays and are supplied complete with cylinder lock and 2 keys

## FIXING

### FLOOR FIXING SET



#### ART. F AR 8999 00 99

Floor fixing kit consisting of 2 M16x140 mm steel expansion bolts for non-cracked concrete floors, class higher than or equal to: C20/25.

ALL LOAD CAPACITY VALUES ARE NET AND REFER TO EVENLY DISTRIBUTED WEIGHTS





P 41

P 31

P 2,1

P 1,1

N 41

N 31

N 21

N 11